

APPENDIX K: Waste and Water Management Design for MOP Application

**TINTINA RESOURCES INC.
BLACK BUTTE COPPER PROJECT**



**WASTE AND WATER MANAGEMENT DESIGN
FOR MOP APPLICATION**

PREPARED FOR:

Tintina Resources Inc.
Suite 2560 – 200 Granville Street
Vancouver, BC V6C 1S4

PREPARED BY:

Knight Piésold Ltd.
Suite 1400 – 750 West Pender Street
Vancouver, BC V6C 2T8 Canada
p. +1.604.685.0543 • f. +1.604.685.0147

VA101-460/3-2
Rev 8
July 6, 2017

Knight Piésold
CONSULTING
www.knightpiesold.com

**TINTINA RESOURCES INC.
BLACK BUTTE COPPER PROJECT**

**WASTE AND WATER MANAGEMENT DESIGN FOR MOP APPLICATION
VA101-460/3-2**

Rev	Description	Date
0	Issued in Final	October 15, 2015
1	Issued with Revisions	December 3, 2015
2	Issued with Revisions	March 10, 2016
3	Issued with Revisions	May 20, 2016
4	Issued with Revised Figures	May 24, 2016
5	Issued with Revised Figures	July 20, 2016
6	Issued with Revisions	April 21, 2017
7	Issued with Revision	May 1, 2017
8	Issued with Revisions to Drawings	July 6, 2017

Knight Piésold Ltd.

Suite 1400

750 West Pender Street

Vancouver, British Columbia Canada V6C 2T8

Telephone: (604) 685-0543

Facsimile: (604) 685-0147

www.knightpiesold.com

Knight Piésold
CONSULTING

EXECUTIVE SUMMARY

The Black Butte Copper Project is a copper mine being developed by Tintina Resources Inc. (TRI). The Project is located 32 km north of White Sulphur Springs, Montana. The mine permit boundary encompasses 763.9 hectares (1,887.7 acres) of land on long-term mining leases composed of private ranch lands and 100% owned federal mining claims. The Project involves mining 13.2 Mt of high-grade ore using underground mining methods at a rate of approx. 3,300 tpd over 15 years. Approximately 45% of the tailings produced in milling will be used underground as backfill and the remaining 55% will be stored on surface.

Knight Piésold Ltd. (KP) completed the feasibility level design of the waste and water management facilities. Tailings stored on surface will be thickened with cement and fly ash or slag prior to deposition in the Cemented Tailings Facility (CTF) to create a non-flowable, low permeability tailings mass. Process water will be stored in a separate Process Water Pond (PWP) and water that collects in the CTF will be pumped to the PWP for storage. The feasibility design was based on the preferred locations for the waste and water management facilities, as determined with TRI. All design work completed by KP and presented in this document was completed under the supervision of Ken Brouwer, P.E., the Engineer of Record for the CTF. Ken Brouwer is a registered Professional Engineer in the State of Montana (License 10020PE) with over 30 years of experience specializing in mining waste management.

This feasibility design was completed using the October 2015 production schedule (developed by AMEC and Tetra Tech) as the design basis. Ultra-thickened tailings with a solids content of 79% will be pumped from the mill for storage at the CTF. The tailings will have 0.5% to 2% by weight cement, fly ash or slag additives. The CTF has been sized to permanently store 3.56 Mm³ of tailings, 0.35 Mm³ of waste rock, with provision for short term storage of storm water. The CTF will be operated with a minimal volume of water that will report to a collection sump and be pumped to the PWP for storage.

The CTF and PWP have a HIGH hazard rating based on Montana State, FEMA and ICOLD guidelines for a HIGH hazard classification dam. The Inflow Design Flood (IDF) used to design the water management systems and size the CTF and PWP for storm water storage is the Probable Maximum Flood (PMF). The design earthquake event is the 1 in 10,000 year event.

The CTF utilizes a single embankment to close off the natural topographic containment to the west. A cut-fill balance will be achieved through impoundment shaping to provide the required storage capacity and embankment fill materials. The CTF has a double liner system comprising a 7.6 mm high flow geonet layer sandwiched between layers of 100 mil High Density Polyethylene (HDPE) geomembrane. An internal basin drain will be incorporated above the geomembrane to allow the collection of tailings bleed water and maintain low head on the geomembrane. The basin drain will be connected to a wet well sump and reclaim pump system in the CTF. Tailings bleed water and accumulated storm water will be pumped from the CTF to the PWP where it will be stored and used as process make-up water, or treated and disposed. Water from storm events, including the IDF, will be temporarily stored in the CTF and transferred to the PWP as quickly as possible, once the storage capacity in the PWP is available. The CTF will be constructed in two stages; the Stage 1 impoundment will provide storage for all pre-production development waste rock and 4 years of operational

production. The second and final stage will be constructed in the fourth year of operations and provides the remaining 11 years of tailings storage capacity.

The PWP also utilizes a double liner system of 7.6 mm high flow geonet layer contained between two layers of 100 mil HDPE geomembrane. Seepage through any defects in the upper geomembrane will be collected in the geonet and gravity-delivered to a sump and pump system to be pumped back into the PWP. The PWP will be constructed using a cut-fill balance to provide the required storage capacity and embankment fill materials. The PWP will have sufficient capacity to contain all process water requirements for the mill, the PMF event water reporting directly to the PWP, and storm water reporting to the CTF (up to the 1 in 500 year 24 hour storm event).

Foundation drains will be constructed beneath the CTF and PWP liner systems to collect groundwater flow and potential seepage beneath the impoundments. This water will be delivered to foundation drain collection ponds for pumping back to the CTF and PWP respectively. The CTF surface excavation will locally encounter the groundwater table. All of the other mine facility surface excavations will not encounter the groundwater table.

A non-contact water reservoir (NCWR) will be constructed southeast of the main project facilities. It will be used to store surplus runoff collected from Sheep Creek during the spring freshet. The water will be temporarily stored and released back to Sheep Creek to offset mine site consumptive water use under a water right.

Instrumentation will be installed in the CTF, PWP and NCWR embankment fill and foundations. The instrumentation will be monitored as part of the detailed monitoring plan to be developed for the facilities. The monitoring will be carried out to assess performance and to identify any conditions that differ from those assumed during design and analysis. Amendments to the ongoing designs and/or remediation work can be implemented to respond to changing conditions, should the need arise.

The primary objective of reclamation and closure activities will be to ensure physical and chemical stability of the CTF, PWP and NCWR, and ensure that acceptable downstream water quality is maintained. Closure and reclamation will focus on removal of surface infrastructure (except for the CTF and the CTF diversion channel) and exposed liner systems, and covering exposed tailings. Additional closure work will involve progressive reclamation and revegetation of the embankments and any other disturbed surfaces.

TABLE OF CONTENTS

	PAGE
EXECUTIVE SUMMARY	i
TABLE OF CONTENTS.....	i
1 – INTRODUCTION.....	1
1.1 PROJECT DESCRIPTION.....	1
1.2 BACKGROUND	1
1.3 SCOPE OF REPORT	1
2 – SITE CHARACTERISTICS	3
2.1 TOPOGRAPHY AND VEGETATION.....	3
2.1.1 Wetlands Categorization.....	3
2.2 CLIMATE AND PRECIPITATION	5
2.3 GEOLOGY	5
2.3.1 Regional Geology	5
2.3.2 Local Bedrock Geology.....	5
2.4 QUATERNARY FAULTING POTENTIAL	6
2.5 HYDROGEOLOGICAL CONDITIONS.....	6
3 – TAILINGS MANAGEMENT ALTERNATIVES ASSESSMENT	7
3.1 GENERAL	7
3.2 SELECTION CRITERIA.....	7
3.2.1 Sub-Aqueous Tailings Disposal.....	7
3.2.2 Dewatered (Dry Stack) Tailings	8
3.2.3 Cemented Tailings	9
3.2.4 Preferred Tailings Management Option.....	9
3.3 FACILITY LOCATION ASSESSMENT	9
4 – DESIGN BASIS	11
4.1 GENERAL	11
4.2 DESIGN STANDARDS	11
4.2.1 MCA 82-4-3.....	11
4.2.2 ARM Guidelines	11
4.2.3 FEMA Guidelines	12
4.2.4 ICOLD Guidelines	12
4.3 HAZARD POTENTIAL CLASSIFICATION	13
4.4 TAILINGS CHARACTERISTICS.....	13
4.5 SEISMICITY.....	14
5 – CEMENTED TAILINGS FACILITY.....	15
5.1 DESIGN CONCEPTS	15
5.2 EMBANKMENT STAGING	15

5.3	CTF LINING SYSTEM AND SEEPAGE CONTROL.....	16
5.4	CTF BASIN DRAIN	17
5.5	CTF FOUNDATION DRAIN	17
5.6	EMBANKMENT CROSS SECTION.....	18
5.7	EMBANKMENT FREEBOARD	18
5.8	SEEPAGE COLLECTION SUMP	19
5.9	WATER RECLAIM SYSTEM	19
5.10	TAILINGS DELIVERY AND DEPOSITION	20
5.11	WASTE ROCK CO-DISPOSAL	20
5.11.1	Waste Rock Characteristics.....	20
5.11.2	Temporary Waste Rock Storage and Ore Stockpile Pad	20
5.11.3	Waste Rock Co-Disposal During Operations.....	21
6	– PROCESS WATER POND	22
6.1	DESIGN CONCEPTS	22
6.2	PWP LINER AND SEEPAGE COLLECTION AND RECLAIM SYSTEM.....	22
6.3	PWP FOUNDATION DRAIN.....	22
6.4	EMBANKMENT CROSS SECTION.....	23
6.5	EMBANKMENT FREEBOARD	23
6.6	WATER RECLAIM SYSTEM	23
7	– NON-CONTACT WATER RESERVOIR	25
7.1	GENERAL	25
7.2	EMBANKMENT FILL ZONES	25
7.3	SPILLWAY CONFIGURATION.....	25
7.4	SEEPAGE AND DISCHARGE MANAGEMENT	26
7.5	RUNOFF DIVERSION	26
8	– SEEPAGE AND STABILITY ANALYSES	27
8.1	STABILITY ANALYSES	27
8.1.1	Modelling Approach	27
8.1.2	Design Criteria	27
8.1.3	Material Strength Parameters.....	27
8.1.4	CTF Stability Analyses.....	28
8.1.5	PWP Stability Analyses.....	29
8.1.6	NCWR Stability Analysis.....	30
8.2	SEEPAGE ANALYSES.....	31
8.2.1	Modelling Approach	31
8.2.2	CTF and PWP Seepage Analyses.....	31
8.2.3	NCWR Seepage Analysis	32
9	– CONSTRUCTION	33
9.1	GENERAL	33
9.2	FOUNDATION PREPARATION	33
9.3	BASIN EXCAVATION, SHAPING, AND SUBGRADE PREPARATION.....	34
9.4	GEOMEMBRANE AND GEONET INSTALLATION.....	34

9.5	CTF BASIN DRAIN	35
9.6	STOCKPILES.....	35
9.7	MATERIAL QUANTITIES	35
9.8	INSTRUMENTATION	37
10	– WATER MANAGEMENT	39
10.1	WATER BALANCE	39
10.2	STORM WATER MANAGEMENT	42
10.2.1	General	42
10.2.2	Surface Water Diversion Channels.....	42
10.3	EROSION CONTROL BEST MANAGEMENT PRACTICES.....	43
10.4	DAM BREACH INUNDATION STUDY	44
11	– OPERATIONS AND MONITORING.....	45
11.1	GENERAL	45
11.2	OPERATIONS.....	45
11.2.1	General	45
11.2.2	Tailings Delivery and Deposition	45
11.2.3	Foundation Drains.....	45
11.2.4	Basin Drain and Water Reclaim System.....	46
11.3	MONITORING.....	46
12	– RECLAMATION AND CLOSURE	48
12.1	GENERAL	48
12.2	POST-CLOSURE MONITORING	49
13	– SUMMARY	51
14	– REFERENCES.....	53
15	– CERTIFICATION.....	56

TABLES

Table 4.1	FEMA Hazard Potential Classification.....	12
Table 4.2	Hazard Summary and Design Criteria.....	13
Table 8.1	Soil Strength Parameters	27
Table 8.2	Rock Strength Parameters	28
Table 8.3	Results of CTF Stability Analyses	28
Table 8.4	Results of PWP Stability Analyses	29
Table 8.5	Results of NCWR Stability Analysis	31
Table 9.1	Overall Cut and Fill Quantities.....	36
Table 9.2	Construction Material Quantities for Primary Facilities	37
Table 10.1	Annual Make-Up Water Requirements.....	40
Table 10.2	Storm Event Summary	42

FIGURES

Figure 2.1	General Arrangement with Wetland Categories.....	4
Figure 4.1	Tailings Gradation	14
Figure 5.1	CTF Filling Schedule	16
Figure 8.1	CTF Typical Cross-Section	29
Figure 8.2	PWP Typical Cross-Section	30
Figure 8.3	NCWR Typical Cross Section	30
Figure 10.1	Annual Water Schematic – Mean Case – Year 6.....	41

APPENDICES

Appendix A	Design Basis
Appendix B	Design Drawings
Appendix C	Tailings Physical Testing Results
Appendix D	Site Wide Water Balance
Appendix E	Tailings Delivery System Design

ABBREVIATIONS

ARM.....	Administrative Rules of Montana
ARD	acid rock drainage
BBCP or the Project	Black Butte Copper Project
CTF.....	Cemented Tailings Facility
DNRC	Department of Natural Resources
EDGM.....	earthquake design ground motion
FEMA.....	Federal Emergency Management Agency
HDPE.....	High Density Polyethylene
PWP	Process Water Pond
FOS	Factor of Safety
ICOLD.....	International Commission on Large Dams
MCA 82-4-3	Montana Code Annotated, Title 82, Chapter 4, Part 3
MCE.....	Maximum Credible Earthquake
MDE.....	Maximum Design Earthquake
MOP	Mine Operating Permit
Mt.....	million tonnes
NCWR	Non-Contact Water Reservoir
PGA	Peak Ground Acceleration
PMP	Probable Maximum Precipitation
PMF	Probable Maximum Flood
PWP	Process Water Pond
SB 409.....	Senate Bill 409
TOMS	Tailings Operation, Maintenance, and Surveillance
tpd.....	tonnes per day
TRI.....	Tintina Resources Inc.
TT	Tetra Tech
WTP.....	Water Treatment Plant

1 – INTRODUCTION

1.1 PROJECT DESCRIPTION

The Black Butte Copper Project (the Project) is a copper mine being developed by Tintina Resources Inc. (TRI). It is located approximately 32 km north of White Sulphur Springs, Montana. The mine permit boundary encompasses 763.9 hectares (1,887.7 acres) of land on long-term mining leases consisting of private ranch lands and 100%-owned federal mining claims. The site is approximately 5 km west of U.S. Highway 89, and is accessible by maintained gravel roads.

The deposit is located within an extensive dolomitic shale-hosted series of bedded sulphide zones that occur at multiple levels down to a depth of 750 m. A total of 13.2 Mt of high-grade ore will be extracted using underground mining methods at a rate of approx. 3,300 tpd over a 15 year mine life. Approximately 45% of the tailings generated from milling will be used underground as backfill and the remaining 55% will be stored on surface.

Knight Piésold Ltd. (KP) has completed feasibility level designs of the waste and water management facilities. Other consultants involved in the project include Tetra Tech (TT) as the lead consultant and process designer, AMEC as the underground mine and backfill design engineer and Geomin Resources Inc. (GRI) overseeing environmental and mine permitting.

1.2 BACKGROUND

TRI prepared a Preliminary Economic Assessment (PEA) in 2011, which was updated in 2013. As part of the initial PEA development, KP completed a tailings management facility (TMF) alternatives assessment (KP Ref. No. VA101-460/01-2 Rev 1, February 22 2012) and prepared pre-feasibility level designs and cost estimates for a 2-stage, HDPE lined TMF (KP Ref. No. VA101-460/01-1 Rev 3, May 3 2013). The feasibility level design contained herein was completed concurrently with ongoing mine design and planning and used the production schedule developed by AMEC and Tetra Tech, last updated in October 2015.

1.3 SCOPE OF REPORT

KP has developed feasibility level designs for the following waste and water management facilities:

- Cemented Tailings Facility (CTF): an HDPE geomembrane double-lined impoundment that will contain all tailings to be stored on surface and all waste rock brought to surface, with additional capacity to store water from a Probable Maximum Flood event that reports directly to the CTF. Water from the PMF event can be temporarily stored in the CTF until storage capacity is available in the PWP.
- Process Water Pond (PWP): an HDPE geomembrane double-lined impoundment that will contain all process water for mill use, storm run-off, and storm event water from the CTF (up to and including the 1 in 500 year 24 hour storm event).
- Non-Contact Water Reservoir (NCWR): a partially lined impoundment that will store non-contact (fresh) water to mitigate mine site consumptive water use. The water will be released back to Sheep Creek over the year to offset a portion of mine site consumptive water use under a water right.

Specific items included in the designs are listed below.

- Embankment and basin lining systems, including a basin drain for the CTF.
- Foundation drains and seepage collection and return systems for the CTF and PWP.
- Diversion channels above the PWP and CTF to intercept runoff and direct it to an energy dispersal structure downstream of the CTF. The channels are sized for the PMF event. Water from the settlement ponds will be allowed to flow into the wetlands downstream, as it is non-contact water.
- A diversion channel to direct water around the NCWR. This channel will be sized for the 1 in 100 year 24 hour storm event.
- Reclaim water pumps and pipelines to transfer water from the CTF to the PWP and from the PWP to the mill or water treatment facility.
- Freshwater pump and pipeline system to deliver water from the Sheep Creek collection point to the NCWR.
- Tailings delivery pumps and pipelines to deliver cemented tailings from the mill to the CTF.
- Temporary surface waste rock facility and management plans.
- Ore stockpile pad.

This report presents a summary of the design work and drawings developed for the Project, including assumptions and identified risks or opportunities. All design work completed by KP and presented in this document was completed under the supervision of Ken Brouwer, P.E., the Engineer of Record for the CTF. Ken Brouwer is a registered Professional Engineer in the State of Montana (License 10020PE) with over 30 years of experience specializing in mine waste management.

2 – SITE CHARACTERISTICS

2.1 TOPOGRAPHY AND VEGETATION

The Project is located at approximately 1,700 to 1,850 masl in relatively flat grassland surrounded by semi-mountainous area. Vegetation consists primarily of grass and low lying shrubs with sparse woodlands along select hilltops that have been left by local ranching activities.

2.1.1 Wetlands Categorization

Westech Environmental Services Inc. under contract to TRI has prepared wetland delineation maps and wetlands are further categorized based on their functionality using the Montana Wetland Assessment Method (Berglund and McEldowney, 2008). This system rates the functionality of the wetlands using up to 12 functions or values, including:

- Plant and animal habitat.
- Flood attenuation.
- Long and short term water storage and groundwater discharge/recharge.
- Food chain support (aquatic and terrestrial).
- Uniqueness.
- Recreation or education potential.

Functional points are summed up and expressed as a percentage of the possible total score. This score is combined with other criteria (such as wetland size and geomorphology) and the overall wetland is ranked into one of four categories. Category I wetlands have the highest overall ranking that a wetland can receive, with Category IV wetlands receiving the lowest overall score.

The majority of wetlands within the Project area are Category II and III. Figure 2.1 shows the distribution of wetlands throughout the Project area.

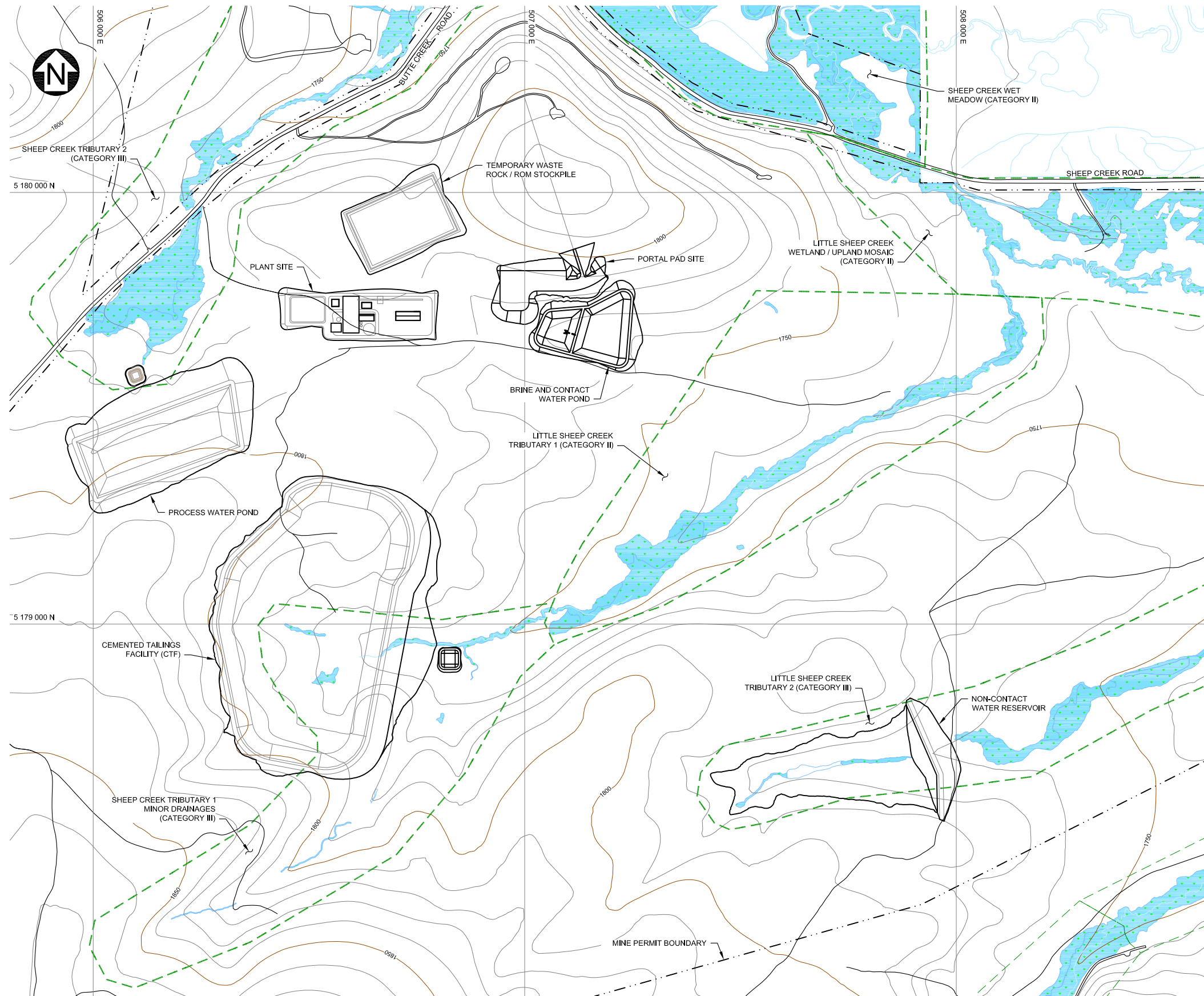

PLAN
SCALE A

- LEGEND:**
- CTF ALTERNATE CELL LOCATION
 - - - MINE PERMIT BOUNDARY
 - - - TRIBUTARY WATERSHED BOUNDARY
 - WETLANDS

- NOTES:**
1. TOPOGRAPHIC BASE MAP FROM 2011 AERIAL LIDAR SURVEY WITH MAP PROJECTION: UTM ZONE 12N AND MAP DATUM: NAD83.
 2. CONTOUR INTERVAL IS 10 METERS.
 3. ELEVATIONS ARE IN METRES, UNLESS NOTED OTHERWISE.
 4. WETLAND AREAS WITHIN THE CTF WILL BE BACKFILLED DURING CONSTRUCTION.

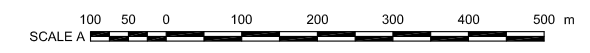

TINTINA RESOURCES INC.	
BLACK BUTTE COPPER PROJECT	
GENERAL ARRANGEMENT WITH WETLAND CATEGORIES	
<i>Knight Piésold</i> CONSULTING	P/A NO. VA101-460/3
REF NO. 2	REV 2
FIGURE 2.1	

SAV:ED: M:\101\0460\03\VA\CA\0\FIGS\B10_r_2_4\27\2017 2:48:05 PM - WLAHODA PRINTED: 4/27/2017 2:50:41 PM, Layout, WLAHODA
 XREF FILES: IMAGE FILES:

REV	DATE	DESCRIPTION	DESIGNED	DRAWN	REVIEWED
2	26APR17	ISSUED WITH REPORT	JEF	PP/WAL	KDE

2.2 CLIMATE AND PRECIPITATION

Meteorology estimates for the Project site were obtained using a combination of long term regional data, and site specific data collected by TRI. An analysis of the available meteorological data was completed by KP and presented in the memorandum “Black Butte Copper Project Meteorology Data Analysis Update” (KP Ref. No. VA15-02445, May 27, 2015).

The mean annual temperature for the Project site is estimated to be 1.9 °C. The coldest months are December through February, when the mean monthly temperatures range from -7.8 to -10.2 °C, with lows in the range of -20 to -30 °C. Mean monthly temperatures are below zero from November through March. The warmest months are June through August, when the mean monthly temperatures range from 10.1 to 16.5 °C, and may reach extremes of 35 to 40 °C.

The mean annual precipitation for the Project site is estimated to be 416 mm. The wettest months are May and June, with mean monthly precipitation values of 58 and 72 mm, respectively. The driest months are January and February, with mean monthly precipitation values of 20 and 17 mm, respectively. Based on the mean monthly temperature values, it is expected that most precipitation falls as snow between November and March. The spring freshet, caused by rain and snowmelt, occurs primarily during April and May as temperatures increase.

The mean annual pond evaporation for the Project site is estimated to be 514 mm, which is 98 mm greater than the mean annual precipitation. The highest mean monthly pond evaporation is estimated to occur during July (113 mm). No evaporation is expected from November through to March. The annual pattern of monthly pond evaporation estimates is consistent with the temperature pattern, whereby the highest monthly temperatures coincide with the highest pond evaporation.

2.3 GEOLOGY

2.3.1 Regional Geology

The copper-cobalt deposits of Black Butte occur in middle Proterozoic sediments of the Belt Supergroup, which are extensively exposed in an eastward protrusion of the Rocky Mountain chain called the Helena salient in central Montana (Zieg and Leitch 1993).

During formation of the Belt Basin, a deep water middle Proterozoic calcareous shale facies (Newland Formation) deposited in an embayment, known as the Helena embayment, which extended in a trough-like fashion east into the craton through central Montana (Godlewski and Zieg 1984). The northern boundary of the deeper water portion of the Helena embayment lay along the southern flank of the Little Belt Mountains north of White Sulphur Springs, Montana. During the Cretaceous Laramide orogeny, renewed faulting along the ancestral northern margin of the Helena embayment formed the Volcano Valley thrust fault (Winston 1986). The bedded massive sulphides of the Black Butte are concentrated along the northern margin of the Helena embayment along the Volcano Valley Fault zone.

2.3.2 Local Bedrock Geology

The Newland Shale hosts the Black Butte massive sulphides and consists of a lower dolomitic shale-dominated part which measures approximately 760 m thick and an upper carbonate-dominated part approximately 350 m thick. The shale was deposited as microturbidites in a sub-wavebase

depositional setting. Debris flow conglomerates punctuate the section along the northern margin of the embayment. Though in places the lower Newland shale shows ubiquitous bedded pyrite throughout, more typically sulphides are concentrated in several discrete stratigraphic horizons of greater lateral extent.

2.4 QUATERNARY FAULTING POTENTIAL

A geological study was completed by Whitehall Geogroup Inc. to determine if there is any Quaternary faulting activity in the general area of the CTF (Whitehall, 2017). The study comprised a review of existing geological mapping and LIDAR scanning data, as well a targeted mapping program completed by Whitehall Group Inc.

Previous studies in this area have mapped faults that offset the Proterozoic to earliest Eocene rocks, but the youngest documented activity on these faults occurred during the late Cretaceous and early Eocene. Geologic mapping done by others and in this study indicates that there is no evidence of these older faults or any new faults being active during the Quaternary. This conclusion is supported by LIDAR data analysis and geologic field observations of Cenozoic deposits in the project area, which indicate that the deposits are not disrupted by faulting.

2.5 HYDROGEOLOGICAL CONDITIONS

In-situ hydrogeological testing was completed in March and May of 2015 as part of a site investigation program. A total of 59 falling head response tests were conducted in relatively shallow weathered and competent bedrock throughout the Project area (maximum test depth approximately 30 m). A total of 12 tests were completed in weathered bedrock, and the remainder in fresh bedrock. Groundwater levels recorded during testing typically ranged from 5 to 10 m below surface.

Tests completed in weathered bedrock indicate that it has moderate permeability with hydraulic conductivities in the range of 6×10^{-8} to 2×10^{-5} m/sec. The average measured permeability for weathered bedrock is 9×10^{-7} m/sec. Tests completed in fresh bedrock across the project area typically show a low to moderate permeability with hydraulic conductivities estimated in the range of 1×10^{-9} to 1×10^{-6} m/sec. The average permeability of the fresh bedrock is 4×10^{-7} m/sec based on the completed tests.

3 – TAILINGS MANAGEMENT ALTERNATIVES ASSESSMENT

3.1 GENERAL

An assessment of tailings management technologies and facility locations was performed to determine the most suitable solution for tailings and site-wide water management. Several storage methods have been successfully employed at operating mines throughout the world, including sub-aqueous slurry deposition, ultra-thickened (paste) tailings disposal and dewatered (dry-stack) tailings. The purpose of the alternatives assessment was to identify the advantages and disadvantages of the disposal methods and use that information to determine the preferred tailings management method for the Project.

3.2 SELECTION CRITERIA

Storage methodologies were reviewed during a group session involving KP, TRI, TT and GRI in February 2015. Multiple options for tailings management were assessed with the following considerations:

- Technical: the suitability of the engineered elements of the proposed options for the site conditions and the requirements of the Project.
- Economic: high level assessment of the cost magnitude associated with the proposed options.
- Environmental impacts: qualitative considerations including disturbance areas, dust control, flood event and seepage control, and impact on the local wetlands and watershed.
- Public (socio-economic) concerns: consideration of available feedback provided to TRI from landowners, local residents, and non-governmental organizations.
- Construction, operation, and closure: integration of the tailings management facility with other mine site facilities.

The group discussion identified three potential tailings management options for the Project:

- Sub-aqueous deposition of slurry tailings.
- Dewatered (dry-stack) tailings with a separate process water storage pond.
- Cemented tailings with a separate process water storage pond.

The overburden throughout the project area typically exists as a thin veneer and the near surface bedrock exhibits a relatively high permeability. Therefore it was determined that the TMF and related contact water control structures would be lined, regardless of the selected management option.

3.2.1 Sub-Aqueous Tailings Disposal

Sub-aqueous deposition of slurry tailings is a common method of tailings management. Tailings slurry is pumped or gravity fed to an impoundment and discharged into the facility from offtakes located along the embankment(s) or around the perimeter of the facility. The coarse fraction of the tailings tends to settle more rapidly and accumulates closer to the discharge points, forming a gentle beach with a typical slope of about 1%. Finer tailings particles tend to travel further and settle at a flatter slope. Selective tailings deposition is used to keep the supernatant pond away from the embankments to enhance stability and reduce potential seepage from the facility. For the storage of potentially acid generating (PAG) tailings, the supernatant pond provides coverage of the tailings solids to prevent the onset of acid generation. The supernatant water released during the initial settling of the solids is typically reclaimed to the process plant for re-use. The tailings continue to settle and consolidate over

time releasing more water; this additional supernatant water would be collected and recycled to the extent possible.

The tailings slurry can also be thickened prior to deposition. Thickened tailings can be pumped to the facility using centrifugal pumps up to a certain slurry density, which can reduce the required pumping power. Positive displacement pumps are required at a very high slurry density. These are power intensive and significantly impact capital and operating costs.

A supernatant pond acts as the primary water management pond and provides capacity for storm runoff, a buffering volume for variability of climatic conditions and storage for process water during periods of low rainfall and/or runoff (e.g. winter operations).

3.2.2 Dewatered (Dry Stack) Tailings

Dewatered tailings are produced using pressure or vacuum force in presses, drum or belt filtration units. These tailings are typically dewatered to a moist cake-like consistency with a water content sufficiently low to achieve partial saturation of the tailings solids. The dewatered tailings cannot be pumped at this density and are transported by conveyors or trucks to a 'dry' stack where they can be compacted in lifts to enhance density, trafficability and stability.

Dewatered tailings typically do not require an embankment, although a rockfill buttress is needed around the perimeter of the stack to maintain geotechnical stability and prevent erosion by surface water runoff. Based on the relatively high permeability of the near surface bedrock at the Black Butte site, it was assumed that a lined impoundment would be required for dewatered (dry-stack) tailings storage.

The cost of operating a dewatered tailings facility is typically higher than a conventional sub-aqueous slurry tailings facility; however, process water recovery is more efficient and can prove beneficial at sites where make-up water is expensive or difficult to obtain. Winter operations in cold climates can present challenges for a dewatered tailings facility. Snow and ice accumulation on the stack and wind-blown dusting can worsen in winter months, and freeze-drying and other frost processes can loosen the placed tailings. During wetter seasons, infiltration can result in rapid degradation of trafficability of the tailings surface and may prevent adequate compaction. The dewatered tailings stack may be susceptible to instability due to ice lenses or localized liquefaction if the pile becomes saturated due to rainfall, snow entrainment, or percolation from runoff.

The moist tailings solids placed in the stack are unlikely to remain dry during periods of high rainfall or snowmelt, such as spring freshet. Snow removal would be required throughout the winter to allow for on-going tailings placement and to reduce the impacts of the snowmelt in the spring. Allowances would need to be made for placement of tailings at an alternative location during periods of heavy snow, extremely cold weather, and heavy rainfall, as the conditions on the stack may not be suitable for tailings placement.

A separate water management pond is required to store process water and storm water runoff from the surface of the facility, as water cannot be stored on the dry stack. The water management pond would need to be large enough to manage storm water runoff and to provide a buffering volume for fluctuations in process water requirements and periods of low rainfall and/or runoff, such as during winter operations. The associated dam(s) and basin would require appropriate lining to prevent seepage losses.

3.2.3 Cemented Tailings

Cemented tailings are a variation of ultra-thickened (paste) tailings with cement, fly ash or slag additives to create a non-flowable, low permeability tailings mass once the tailings are deposited and have set up. Cemented tailings are typically deposited as underground backfill for mining stopes and voids. TRI plans to use approximately 45% of the tailings as underground backfill for the Project and the remaining 55% will be stored on surface.

Cemented tailings with higher slurry solids content are produced in gravity thickeners (paste plant) with the addition of flocculants to increase the rate of sedimentation and enhance liquid-solids separation. Therefore, a large proportion of the recoverable process water is reclaimed in the thickeners and the remaining tailings are mixed with cement, fly ash or slag and transported to the storage facility by pumping. Cemented tailings typically do not segregate during or after deposition and therefore produce only minimal amounts of bleed water after being delivered to the facility.

Positive displacement pumps are often required to transport ultra-thickened cemented tailings. These pumps are significantly more expensive to purchase and operate when compared to the centrifugal pumps typically used for conventional sub-aqueous slurry tailings transport.

A separate process water management pond (PWP) will be required to store process water and storm water runoff. The PWP would need to be large enough to manage storm water runoff and to provide a buffering volume for fluctuations in process water requirements and periods of low rainfall and/or runoff, such as during winter operations.

3.2.4 Preferred Tailings Management Option

Cemented tailings disposal was selected as the preferred tailings management option for the Project for the following reasons:

- Cemented tailings will be produced for underground mine backfill and surface deposition of these tailings can use the thickening plant, cement plant (located on the northwest corner of the mill pad), and some components of the pump and pipeline systems.
- The tailings will form a non-flowable tailings mass after they have set up, which will provide a stable tailings mass comparable to a dry stack tailings.
- The tailings will be low permeability (in the order of 8×10^{-8} m/sec, based on lab testing of straight tailings with no binding agents) to reduce potential seepage rates through the lining system. The CTF can be operated with a minimal volume of impounded water through use of the water reclaim and sump systems, which significantly reduces the risk of seepage occurring when compared to conventional sub-aqueous tailings deposition.
- Water recovery from mill processes is maximized at the thickening plant, reducing the overall volume of water trapped in tailings voids and losses from evaporation.
- Cemented tailings will allow for a faster reclamation schedule.

3.3 FACILITY LOCATION ASSESSMENT

A high level locations assessment was completed using the modelling software Muck3D (Minebridge Software Inc. 2013). Several iterations of the CTF, PWP and NCWR were modelled with the intent to minimize the impact on wetlands, and minimize embankment fill volume while maintaining a material cut-fill balance for construction of the facilities.

The results of the assessment showed that the optimum location for the CTF is in a broad, shallow valley south of the mill. This location is approximately 380 m upstream of Category I wetlands areas, and the shallow topography surrounding the facility allows easy access for construction and operations. Some Category III wetlands (0.17 hectares and approximately 200 m of streams) are located within the footprint of the CTF and will be backfilled during construction. The area of wetlands and streams to be filled during the construction of the CTF is shown on Figure 2.1.

The PWP location is immediately west of the mill, northwest of the CTF, set against a shallow sloping hillside. This location was selected for its proximity to the mill and CTF. The footprint of the PWP does not overlap any wetlands area.

The NCWR is located southeast of the CTF, at the mouth of a narrow, shallow valley. The NCWR location was selected because it drains directly to wetlands, has a small footprint area, and does not overlap any Category I wetlands. Some Category II wetlands will be flooded at this location, but no wetlands areas will be disturbed by dredging or filling as part of construction or operations.

4 – DESIGN BASIS

4.1 GENERAL

The design basis and process criteria used for the design and analysis of the CTF, PWP and NCWR are based on the available information and operational requirements confirmed with TRI. The design basis for pertinent portions of the design, construction and operations of the waste and water management facilities are discussed in the following sections.

A detailed project design basis summary is included in Appendix A of this report.

4.2 DESIGN STANDARDS

The design basis and criteria for the waste and water management facilities have been developed to satisfy both US and international standards. Design standards are based on the relevant state and federal guidelines for the construction and operation of a dam in Montana. The following regulations and guidelines were used to develop the design standards for the Project:

- Montana Code Annotated, Title 82. Minerals, Oil, and Gas, Chapter 4. Reclamation, Part 3. Metal Mine Reclamation (MCA 82-4-3).
- Administrative Rules of Montana (ARM).
- Federal Emergency Management Agency (FEMA).
- International Commission on Large Dams (ICOLD).

4.2.1 MCA 82-4-3

Montana State Legislature passed a new legislation on April 5, 2015 as the governing legislative document for metal mining in the State of Montana. The requirements listed in the new legislature were incorporated into the Montana Code Annotated, under Title 82. Minerals, Oil, and Gas, Chapter 4. Reclamation, Part 3. Metal Mine Reclamation (MCA 82-4-3). All requirements of MCA 82-4-3 will be addressed for the ongoing design, construction and operation of the Project. The intent of the bill is to ensure that tailings storage facilities are designed, operated, monitored, and closed in a manner that:

- Meets state of practice engineering design standards.
- Uses applicable, appropriate, and current technologies and techniques as is practicable given site-specific conditions and concerns.
- Provides protection of human health and the environment.

MCA 82-4-3 states that new dams operating in Montana must be designed to withstand either the Maximum Credible Earthquake Event (MCE), or the 1 in 10,000 year earthquake event, whichever is greater. New dams operating in Montana must also be built to handle the Probable Maximum Flood (PMF) event.

4.2.2 ARM Guidelines

The dam hazard determination described in the ARM is based on the consequences of dam failure (not the condition, probability, or risk of failure). According to ARM Chapter 16.14, a dam must be classified as a high hazard if the impoundment capacity is approx. 60,000 m³ (50 acre-feet) or larger and it is determined that a loss of human life is likely to occur within the breach flooded area as a result of failure of the dam. The CTF and PWP both have capacities exceeding 60,000 m³ and local

landowners have semi-permanent settlements downstream of the facilities that would be impacted by a dam failure.

The ARM specifies the following with respect to earthquake and flood criteria for high hazard dams:

- The design must be such that the most severe earthquake that can be reasonably anticipated will not cause catastrophic failure and loss of life.
- Spillway conveyance for high hazard dams will be based on estimated loss of life downstream from the dam caused by spillway failure. The minimum inflow design flood for estimated loss of life greater than or equal to 1,000 shall be the Probable Maximum Flood (PMF).

4.2.3 FEMA Guidelines

The US Department of Homeland Security published federal guidelines for dam safety (FEMA, 2004). The guidelines include a hazard potential classification system which categorizes dams based on the probable loss of human life and the impacts on economic, environmental, and lifeline interests. Improbable loss of life exists where persons are only temporarily in the potential inundation area. For instance, this hazard potential classification system does not contemplate the improbable loss of life of the occasional recreational user of the river and downstream lands, passer-by, or non-overnight outdoor user of downstream lands. The FEMA hazard potential classification system is summarized in Table 4.1.

Table 4.1 FEMA Hazard Potential Classification

Hazard Potential Classification	Loss of Human Life	Economic, Environmental, Lifeline Losses
Low	None Expected	Low and generally limited to owner
Significant	None Expected	Yes
High	Probable. One or more expected.	Yes (but not necessary for this classification)

FEMA guidelines specify the inflow design flood (IDF) required for dams in Montana. The design of dams that have a “significant” or “high” hazard classification should have an IDF based on the PMF. A smaller flood may be selected for design if a “low” hazard potential class is assigned. However, all dams should be designed to withstand a relatively large flood without failure even when there is apparently no downstream hazard involved under present conditions of development.

The final selection of the Maximum Design Earthquake (MDE) considers whether or not the dam must be capable of resisting the controlling Maximum Credible Earthquake (MCE) without catastrophic failure, such as uncontrolled release of a reservoir, although severe damage or economic loss may occur. For high hazard potential classification dams, the MDE usually is equated with the controlling MCE. However, for low or significant potential classification hazard dams the MDE may be determined based on faults active in Holocene time, or according to other agency specified criteria.

4.2.4 ICOLD Guidelines

ICOLD recommends that for major tailings dams, where failure could result in loss of life and extensive property damage, seismic analysis should be based on the MCE (ICOLD, 1989). Damage of the dam is acceptable as long as the integrity and stability of the dam is maintained and the release of the impounded water and/or tailings is prevented.

The design of major tailings dams, where failure could result in loss of life and extensive property damage, should be based on the PMF. For closed circuit tailings dams, where no discharge is permitted, the tailings dam must provide sufficient freeboard to allow storage of the PMF in addition to normal operational tailings pond containment volumes.

4.3 HAZARD POTENTIAL CLASSIFICATION

The CTF and PWP are considered to have a high hazard potential classification for expected loss of life and extensive property damage in the event of embankment failure. Residential structures exist downstream of the PWP that would be affected by a failure of the PWP embankment. The mine site itself is located within privately owned ranch land, and is upstream of Sheep Creek (a tributary of the Smith River system) and associated wetlands; both of which present potential for economic and environmental losses in the event of a failure.

The NCWR will contain fresh (non-contact) water and only be operated at design capacity during the spring freshet. The consequence of failure of the NCWR is significantly less than that for the CTF and PWP, as a dam breach would cause temporary flooding of the downstream wetlands and ranch lands, but would otherwise not cause long term environmental or economic losses. Loss of life due to a breach of the NCWR is considered low due to the lack of a permanent downstream population. Therefore the hazard potential classification for the NCWR is low.

The hazard potential classification and relevant IDF and MDE for each facility are summarized in Table 4.2.

Table 4.2 Hazard Summary and Design Criteria

Facility	Hazard Classification	Inflow Design Flood	Maximum Design Earthquake
CTF	HIGH	PMF	1 in 10,000 year event
PWP	HIGH	PMF	1 in 10,000 year event
NCWR	LOW	1/200 year	1 in 10,000 year event

4.4 TAILINGS CHARACTERISTICS

Physical testing was conducted on samples of tailings obtained from metallurgical testing. Index and consolidation testing was conducted to characterize the physical properties and estimate the settled dry density of the cemented tailings deposited into the CTF. Rheology and strength testing was also completed on tailings samples. Based on the test work, the following tailings properties have been adopted for the feasibility design:

- Solids content by weight: 79%.
- Specific gravity of the tailings solids: 3.77.
- Average settled dry density: 2.0 t/m³.
- Approximate grain size of the tailings: approximately 94% of the tailings pass the 75 micron (No. 200) sieve, and 55% of tailings pass the 20 micron (No.636) sieve. A gradation curve is shown in Figure 4.1.

Binding agents (a mix of 0.5% to 2% cement, fly ash or slag by weight for surface deposition) will be added to the tailings during thickening that will create a non-flowable mass once the tailings are deposited and have set up.

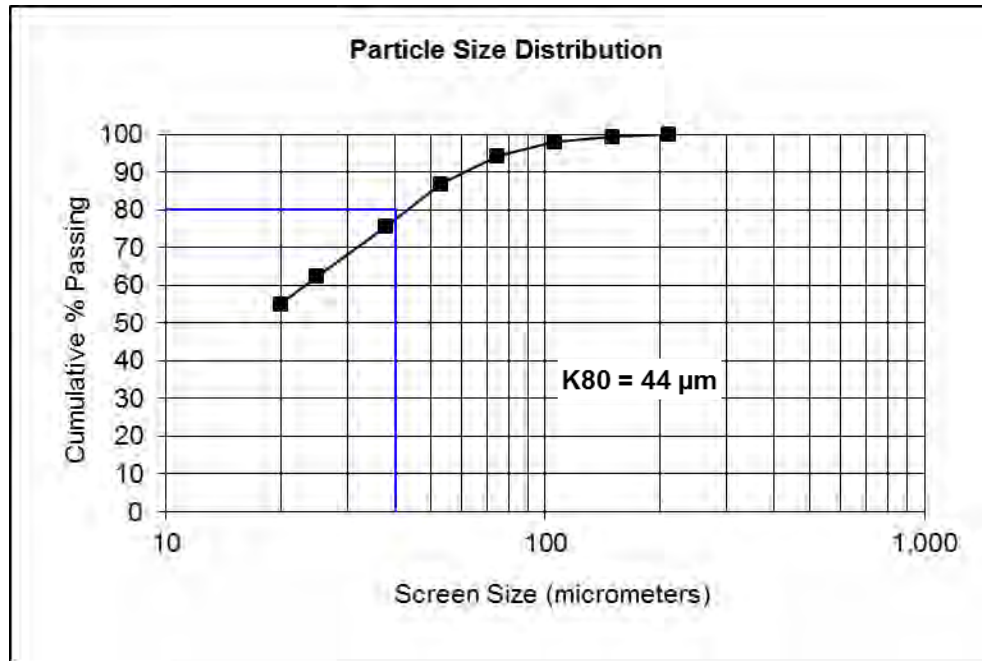

NOTES:

1. Tailings gradation curve is based on average values from lab test results provided by International Metallurgical and Environmental Inc., October 2015.

Figure 4.1 Tailings Gradation

The results of the tailings characterization test work are presented in Appendix C of this report.

4.5 SEISMICITY

MCA 82-4-3 requires that new tailings dams in Montana be able to withstand the greater of either the 1 in 10,000 year earthquake event, or the MCE. To comply with MCA 82-4-3 guidelines the MDE and Earthquake Design Ground Motion (EDGM) has been defined as the 1 in 10,000 year earthquake event which corresponds to a Peak Ground Acceleration (PGA) of 0.35 g. The PGA was defined using the United States Geological Survey (USGS) Uniform Hazard Response Spectra (available on the USGS website <http://geohazards.usgs.gov/hazardtool/application.php>) for the 1 in 10,000 year return period.

The MCE for the Project will be assessed in future design phases, and the MDE will be updated if required at that time.

5 – CEMENTED TAILINGS FACILITY

5.1 DESIGN CONCEPTS

The CTF is sized to store 55% of all tailings generated in the mill over the 15 year mine life and 100% of waste rock brought to surface. The feasibility design was performed concurrently to the mine design and planning and used the October 2015 production schedule as the design basis.

The CTF has a storage capacity of 4.3 Mm³, which include 3.56 Mm³ of cemented tailings (7.12 Mt at a settled density of 2 t/m³), 0.35 Mm³ of waste rock (0.7 Mt at a density of 2.0 t/m³), with additional capacity for temporary storage of storm water up to and including the PMF flood event of 0.3 Mm³. The volume of tailings stored also accounts for the removal of 1.41 Mt of concentrate from the 13.2 Mt of ore.

The PWP is designed to store water from the CTF for a 24 hour storm up to and including the 1 in 500 year event. A wet well sump and pump system within the CTF will be used to transfer water from the CTF to the PWP, and will be designed to pump out water from the 1 in 100 year 24 hour storm event over a 10-day period. The PWP will not have capacity to store the PMF event volumes for both the CTF and PWP. The CTF will have capacity to store runoff and direct precipitation from the PMF event until there is capacity in the PWP to pump the water from the CTF.

5.2 EMBANKMENT STAGING

The CTF will be developed in two stages throughout the life of the mine. This offers the following advantages:

- The ability to reduce initial capital costs and defer some capital expenditures until the mine is operating.
- The ability to refine design, construction, and operating methodologies as experience is gained with local conditions and constraints.
- The ability to adjust plans at a future date to remain current with evolving best practice (engineering and environmental).
- To allow the observational approach to be utilized in the ongoing design, construction and operation of the facility. The observational approach can deliver substantial cost savings and a higher level of safety. It also enhances knowledge and understanding of site-specific conditions.

Stage 1 will be constructed with the liner system installed to El. 1,784 m prior to commencement of milling operations. The Stage 1 CTF will provide storage for 5 years of surface tailings deposition and waste rock placement. It is anticipated that a surplus of fill material will be available at the completion of the Stage 1 construction phase. This excess material will be placed and compacted on the CTF embankment in preparation for the Stage 2 construction to El. 1,799 m. Additional surplus material will be stockpiled for use in closure of the CTF.

Construction of Stage 2 will occur during years 4 to 5. All remaining stripping and grubbing, excavation, and fill placement will occur during this time, as well as the installation of the liner system to the ultimate crest elevation of El. 1,799 m.

The preliminary filling schedule and embankment stages are shown on Figure 5.1. The filling schedule and timing for staged expansions must be reviewed on an on-going basis during operations. The actual rate of filling may vary, depending on a variety of operating factors including:

- Mill throughput.
- Settled tailings density.
- Tailings surface slopes.

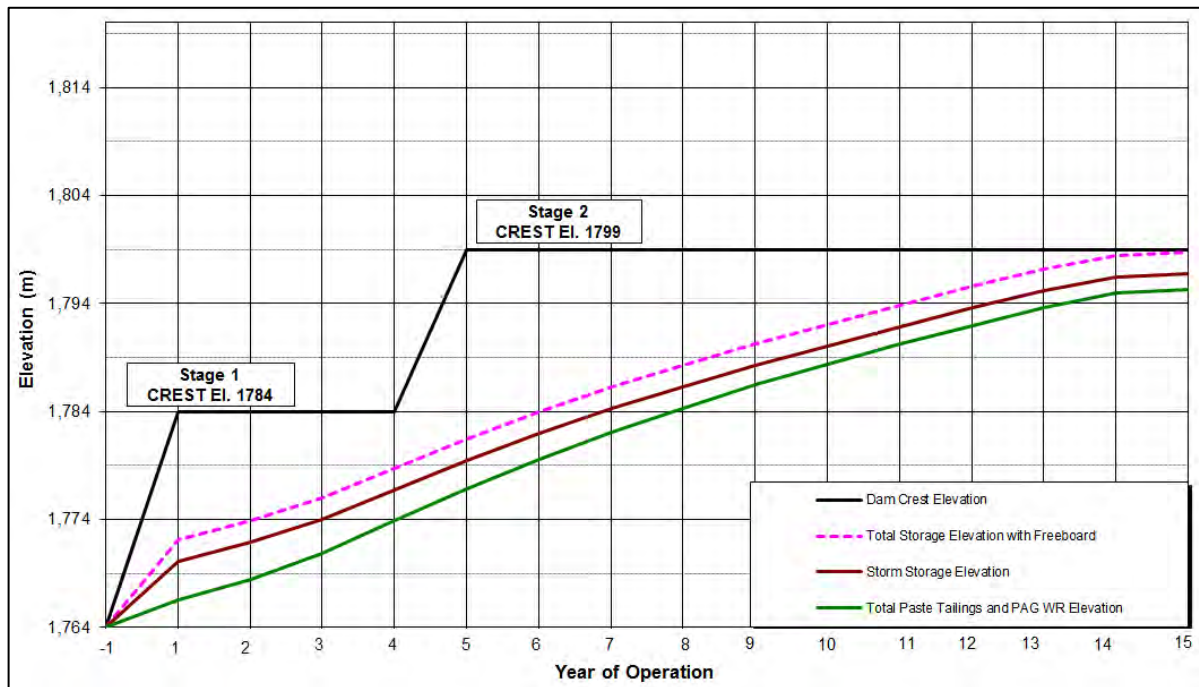

NOTES:

1. Filling schedule based on preliminary production schedule from Tetra Tech (Oct. 2015) and includes storage of 55% total tailings and 0.7 Mt of waste rock.
2. Waste rock will be generated in Year 1 as the mine decline ramp is excavated, stockpiling of ore will begin in Year 2, and processing of ore will begin in Year 3.
3. Storm storage volume is estimated on the basis of containing a PMF event.
4. A minimum freeboard of 2 m will be maintained to control wave run-up.

Figure 5.1 CTF Filling Schedule

5.3 CTF LINING SYSTEM AND SEEPAGE CONTROL

The CTF is fully lined and with a double liner system that consists of a layer of 7.6 mm high-flow geonet sandwiched between layers of 100 mil HDPE geomembrane. The liner system is placed to cover the full interior of the CTF basin with an underlying prepared subgrade comprising processed material obtained from impoundment shaping.

The seepage control measures incorporated into the CTF are as follows:

- Two layers of 100 mil HDPE geomembrane encompassing a layer of high-flow geonet will cover the entire CTF basin and upstream face of the embankment. The geomembrane is intended to be impermeable, with seepage only possible through defects that may occur during fabrication and/or

installation. Any seepage through the upper geomembrane will be collected and transferred to a seepage collection sump and pump system at the north end of the embankment.

- The tailings are low permeability with a hydraulic conductivity in the order of 8×10^{-8} m/sec. The tailings are highly thickened prior to deposition, and most of the remaining interstitial water will hydrate the cement and remain trapped in the tailings, with limited bleed water.
- A basin drain will be constructed above the geomembrane to maintain low head on the geomembrane, thereby minimizing the potential for seepage.
- Minimal water will collect in the facility. Runoff, precipitation and limited bleed water from the tailings will be directed to a water reclaim system within the impoundment. Water from the reclaim system will be pumped to the PWP for storage and mill use.
- A foundation drain will be constructed to collect groundwater and potential seepage flow beneath the geomembrane. The foundation drain will empty into a collection pond and water will be pumped into the CTF, where it will be subsequently collected by the water reclaim system and transferred to the PWP.

5.4 CTF BASIN DRAIN

A basin drain will be installed in the CTF (above the geomembrane) using sub-grade bedding fill material and waste rock generated from the mine and surface construction during the pre-production phase. It will be connected to the wet well sump and pump system in the CTF. The basin drain will collect tailings bleed water and any water that percolates through the tailings mass and convey it to the water reclaim system to be pumped to the PWP. This will facilitate a low phreatic level within the tailings mass and will reduce the head on the geomembrane, which is an effective measure to minimize potential seepage through any small defects in the geomembrane.

The basin drain consists of a layer of pre-production waste rock placed over the sub-grade bedding layer that overlies the HDPE geomembrane, across the entire basin floor. The waste rock will have the same material specifications as the Embankment Fill (as shown on Drawing C0003) and therefore will be a free draining material. The CTF basin floor will be graded at a minimum of 0.5% towards the water reclaim system sump. Details of the basin drain are shown in shown in Section "1" of Drawing C2006.

5.5 CTF FOUNDATION DRAIN

The CTF foundation drain has been designed to collect groundwater flows and seepage below the CTF geomembrane, and to convey all collected flows to a foundation drain collection pond downstream of the CTF.

The CTF foundation drain has the following components:

- Drains on the CTF cut slopes.
- Drains on the CTF Basin Floor.
- Drains beneath CTF Embankments (areas of fill).
- Outlet drain.

The foundation drain comprises an interconnected grid of perforated pipes of various diameter along with surrounding drainage gravel to collectively manage groundwater inflows.

The foundation drains flow to the foundation drain collection pond located at the downstream toe of the CTF embankment. Collected water will be pumped into to the CTF and subsequently transferred to the PWP. The collection pond will be a 100 mil HDPE geomembrane lined pond with a submersible turbine pump. An HDPE pipeline will convey the flows from the pond to the CTF.

Details of the CTF foundation drain, including pipeline lengths, sizes, and minimum required thicknesses of drainage gravel are shown on Drawings C2004 and C2006. Details of the foundation drain collection pond are shown on C6330. Details of the foundation drain collection pond pump system are shown on Drawings C6300, C6310, and C6330.

5.6 EMBANKMENT CROSS SECTION

The CTF has a single embankment to close off the east end of the impoundment, allowing for natural topographic containment to the west. The CTF will be constructed using a cut-fill balance, where excavated materials from impoundment shaping will provide the required storage capacity and fill material for the confining embankment.

The embankment is a homogeneous rockfill embankment. The internal (upstream) slope of the embankment will be constructed at a 2.5H:1V slope to facilitate geomembrane placement. The external (downstream) slope will also be constructed at a 2.5H:1V slope to facilitate concurrent reclamation of the embankment during operations. The embankment crest width will be 10 m to allow working space for tailings and reclaim water pipelines and traffic. The maximum embankment height is approximately 46 m on the downstream side, with an upstream embankment height of 35 m.

The majority of embankment fill will be general fill sourced from excavation as part of the CTF impoundment shaping. The material is expected to consist of fresh to moderately weathered rockfill with topsoil and subsoil overburden material removed.

The geomembrane will be placed on a sub-grade bedding material that will provide a protective layer between the geomembrane and natural ground or embankment fill materials. The sub-grade bedding material will be primarily sourced from weathered bedrock and select fresh rock that meets the required material specifications. General rockfill will be processed as necessary to meet the material specifications. Non-woven geotextile fabric will be placed between the geomembrane and sub-grade bedding.

The CTF plan is shown on Drawing C2001. The CTF sections and details are shown on Drawing C2003.

5.7 EMBANKMENT FREEBOARD

Tailings will be deposited strategically via oftakes along the western and southern basin perimeter. The CTF will be maintained with a minimal volume of stored water, and the tailings surface will be developed to direct surface water towards the wet well sump and pump system.

Under these conditions, sufficient storage capacity will be available to contain all surface tailings, waste rock, runoff, and precipitation (up to and including the design storm event) while maintaining a minimum freeboard of 2 m. Construction will be staged such that the minimum freeboard requirement is maintained, even during the design storm event.

5.8 SEEPAGE COLLECTION SUMP

The seepage collection system will collect seepage through the upper HDPE geomembrane and direct it through the geonet, via gravity, to a sump and pump system at a low point in the CTF basin. Water collected in the sump will be pumped through a discharge pipe to the embankment crest and returned to the CTF. An underlying sub-grade bedding layer will be installed to protect the lining system.

The seepage collection system between the HDPE geomembrane layers will consist of a sump filled with drainage gravel that is deep enough to allow the effective operation of a submersible pump that can be raised and lowered through a protective pipe. The bottom of the pipe will be perforated (in the sump) for pump operation. An additional drain pipe is included for redundancy. The pump will have a high/low water level primer to control pumping (switch on when the water level reaches a high water mark and switch off when the water level reaches the low water mark).

Potential seepage through the lower geomembrane will be intercepted by the CTF Foundation Drain, as discussed in Section 5.5.

Details of the CTF Liner and Seepage Reclaim System are shown on Drawings C6200, C6210, C6220 and C6230.

5.9 WATER RECLAIM SYSTEM

The water reclaim system serves two purposes:

- To allow the removal of water that may be released from the cemented tailings (minimal bleed water expected) and conveyed to the reclaim system by the basin drain.
- To allow the collection and removal of precipitation and runoff (surface water) in the CTF.

All collected water will be pumped to the PWP.

The water reclaim system consists of a wet well sump that will extend to surface. The CTF basin drain will be integrated with the reclaim sump to promote flow to the sump.

The sump comprises a lined depression filled with drainage gravel in the low point of the CTF. The sump will be deep enough to allow the effective operation of a submersible pump that can be raised and lowered through a protective pipe. The drainage gravel will be covered with waste rock to facilitate water flow to the sump, and help prevent migration of tailings fines into the drainage gravel.

The bottom of the pipe will be perforated (in the sump) for pump operation. The pipe will extend in a channel on the embankment face to the embankment crest and will be surrounded by a layer of drainage gravel to allow water infiltration into the system. An additional drain pipe is included for redundancy. The drainage gravel will be surrounded by suitable fill material sourced from excavation of the impoundment. Sub-grade bedding material will be placed to protect the geomembrane. The internal slope of the CTF will be 3H:1V at the sump location to facilitate the placement of drainage gravel and sub-grade bedding materials.

The drainage gravel used to construct the wet well sump and foundation drain will be free draining; durable crushed rock which will be sourced from either select granodiorite fill excavated during impoundment shaping, or quarried from local off-site sources as needed. In addition, processed (crushed and screened) waste rock from pre-production mining could be utilized to help construct the wet well sump as long as these materials are free draining.

The wet well pump will have a high/low water level primer to switch on when the water level in the sump reaches the high water level mark, and switch off when the water level reaches the low water level mark. The system has been designed to pump out a 1 in 100 year 24-hr rainfall event over a period of 10 days (approximately 20 L/s) through a HDPE pipeline to the southeast corner of the PWP (a pipeline length of approximately 730 m).

Details of the CTF Reclaim System are shown on Drawings C6200, C6210, C6220 and C6230.

5.10 TAILINGS DELIVERY AND DEPOSITION

Tailings will be delivered from the mill to the south end of the CTF via an 8-inch PN150 steel pipeline. This delivery system and location is the "Option 3" pipeline route as defined in a separate tailings pipeline and alternatives report by MG Engineering Inc. and KP (MG, 2016), included in Appendix K of the MOP application. The pipeline will run along the west crest of the impoundment and discharge tailings at the southernmost point of the CTF. The pipeline will be double-walled between the mill site and the CTF to capture and contain tailings in the event of a pipeline leak. Double walled pipe will not be required on the CTF crest as tailings will flow into the CTF in the event of a leak.

The Project will be operating in freezing temperatures for a significant portion of each year. Freezing of the pipeline will prevent flow of tailings, and risks rupturing the pipeline due to the crystallization expansion of any water within the line. The pipeline will be insulated to protect against freezing. Additionally, the pipeline will be flushed with water and drained when not in use to prevent freezing and/or plugging.

The tailings delivery system is shown on Drawing C6100.

5.11 WASTE ROCK CO-DISPOSAL

5.11.1 Waste Rock Characteristics

The mine plan indicates that 411,537 t of waste rock will be generated during the first two years of operations (pre-production and ramp up), and 706,525 t of waste rock will be generated over the life of the mine. The waste rock has acid generation and metal leaching potential, and will be co-disposed with the tailings in the CTF during mining operations.

5.11.2 Temporary Waste Rock Storage and Ore Stockpile Pad

A temporary waste rock storage (WRS) pad has been sized to store up to a maximum of 500,000 t of waste rock that will be generated during the pre-production period. This pre-production waste rock will be temporarily stockpiled on an HDPE lined pad, located northwest of the mine portal pad. The pad will have an HDPE geomembrane liner with a protective bedding layer above and below it for protection from the mine fleet traffic during waste rock placement.

The pad will be sloped towards a gravel filled drainage sump with 8-inch outlet pipe at the southern low point of the pad. This outlet pipe will transfer collected run-off to a lined contact water pond adjacent to the mine portal pad. Collected water will be transferred to the PWP or mill for reuse.

The waste rock from pre-production will be transferred into the CTF after installation of the geomembrane across the basin floor has been completed and once the sub-grade bedding layer has been placed above the lining system. A portion of the waste rock may be crushed and/or screened, if

required to create free draining rock fill, and spread over the entire basin floor to create the basin drain prior to beginning tailings deposition, as described in Section 5.4. Additional waste rock will be placed on the basin drain, as needed.

The temporary waste rock pad will be reclaimed after all of the pre-production waste rock is moved to the CTF.

Plans and details of the temporary waste rock storage pad are shown on Drawings C7001 to C7003.

5.11.3 Waste Rock Co-Disposal During Operations

Waste rock will be delivered to and stored in the CTF during operations and integrated with the basin drain and reclaim systems. Waste rock generated throughout the life of the mine will be selectively placed in the CTF around the water reclaim system, in order to promote drainage into the reclaim sump. A ramp will be constructed into the basin of the CTF so that waste rock can be hauled into the impoundment by haul trucks and spread with a dozer. This ramp will be constructed with a mix of excavated general fill material, supplemented with waste rock from the pre-production period.

Waste rock will be intermittently generated throughout the life of the mine, with an additional 200,000 t (approximately) produced during mining operations. The haul ramp into the CTF basin will be maintained to facilitate waste rock placement throughout the life of the mine. The waste rock will extend up the slopes of the CTF basin. Sub-grade bedding material made from processed excavation material will be placed on the geomembrane prior to waste rock deposition to protect the liner system. The exposed waste rock pile will incorporate 2H:1V slopes. The waste rock placement will be staged such that the working surface and water reclaim system will not become inundated by tailings deposition.

The conceptual design of the waste rock co-disposal system is illustrated in Drawing C2008.

6 – PROCESS WATER POND

6.1 DESIGN CONCEPTS

The PWP is a double-lined facility that stores all contact water from the PWP and CTF, including contact water from precipitation and run-off, and collected water from the foundation drain collection ponds. The PWP has a capacity of 420,000 m³ to provide storage for mill water recycle and storm storage. The PWP is designed with an operational capacity of 120,000 m³ to 200,000 m³, which maintains sufficient volume of water to offset evaporation while providing a minimum of 4 months process water supply. Under average climatic conditions the PWP will have up to 80,000 m³ of capacity to allow for temporary water storage caused by variances in operations. The operational volumes have been optimized such that wetter than average year conditions would not encroach on the storm storage above 200,000 m³ in the PWP. The additional 220,000 m³ of capacity will allow for storage of water from storm events.

6.2 PWP LINER AND SEEPAGE COLLECTION AND RECLAIM SYSTEM

The PWP is a double-lined impoundment that has two layers of 100 mil HDPE geomembrane with a 7.6 mm high flow geonet layer sandwiched between the geomembrane layers. The geonet will act as a conduit for potential leakage through the upper geomembrane. Any seepage into the geonet will be directed via gravity to a sump and pump reclaim system at a low point in the PWP basin. Water collected in the sump will be pumped through a discharge pipe to the embankment crest, and back into the PWP. An underlying sub-grade bedding layer will be installed to protect the lining system.

The seepage reclaim system between the HDPE geomembrane layers will consist of a sump filled with drainage gravel that is deep enough to allow the effective operation of a submersible pump that can be raised and lowered through a protective pipe. The bottom of the pipe will be perforated (in the sump) for pump operation. An additional drain pipe is included for redundancy. The pump will have a high/low water level primer to control pumping (switch on when the water level reaches a high water mark and switch off when the water level reaches the low water mark).

Potential seepage through the lower geomembrane will be intercepted by the PWP Foundation Drain, as discussed in Section 6.3.

Details of the PWP liner system are shown on Drawing C3003. Details of the Seepage Collection System are shown on Drawings C6500, C6510, and C6520.

6.3 PWP FOUNDATION DRAIN

The PWP foundation drain will collect groundwater flows below the PWP geomembrane, and to convey all collected flows to a foundation drain collection pond downstream of the PWP.

The PWP foundation drain has the following components:

- Drains on the PWP cut slopes, installed beneath the geomembrane.
- Drains on the PWP basin floor, installed beneath the geomembrane.
- Drains beneath PWP embankments.
- Outlet drain.

The foundation drain comprises an interconnected grid of pipes with various diameters and surrounding drainage gravel to manage groundwater inflows.

The foundation drains flow to a foundation drain collection pond located downstream (north) of the PWP embankment. Collected water will be pumped back to the PWP. The collection pond will be a 100 mil HDPE geomembrane lined pond with a submersible turbine pump. An HDPE pipeline will convey the flows back to the PWP.

Details of the PWP Foundation Drain are shown on Drawings C3004 and C3008. Details of the PWP foundation drain collection pond are shown on Drawing C6330. Details of the collection pond pump system are shown on Drawings C6300, C6310, C6320 and C6330.

6.4 EMBANKMENT CROSS SECTION

The PWP will be constructed prior to the start of mining operations and the surface excavation of the PWP will not encounter the groundwater table. The embankment is a homogeneous rockfill embankment. The internal (upstream) slope of the impoundment will be constructed at a 2.5H:1V slope to facilitate geomembrane placement. The external slope (downstream) will be constructed at a 2.5H:1V slope to facilitate reclamation of the downstream slopes, which can be completed during the early operations period. The crest width will be 10 m to allow working space for pipelines and traffic. The embankment height varies, up to a maximum of approximately 23 m.

The majority of the embankment will be constructed from general fill sourced from excavation as part of the cut-fill balance for the PWP impoundment shaping. The material will consist of fresh to moderately weathered rockfill with organics and loamy material removed.

The geomembrane will be placed on prepared sub-grade bedding material that will provide a protective layer between the geomembrane and natural ground or other fill materials. The fill will be primarily sourced from weathered bedrock and select fresh rock that meets the required material specifications. General rock fill will be processed as necessary to meet the material specifications defined in Drawing C0003. Non-woven geotextile fabric will be placed between the geomembrane and sub-grade bedding.

The PWP plan is shown on Drawing C3001. Sections and details are shown on Drawing C3003.

6.5 EMBANKMENT FREEBOARD

The PWP has been designed to maintain a minimum of 2 m of freeboard at all times. This is in addition to sufficient capacity to contain the required amount of process water, run-off, precipitation, and the design storm event (PMF) reporting directly to the PWP. Additionally, run-off and precipitation reporting to the CTF for storm events up to and including the 1 in 500 year 24 hour storm event will be pumped into the PWP for storage and recycle.

6.6 WATER RECLAIM SYSTEM

The PWP supplies mine process water to the reclaim tank located at the mill. The reclaim system has been sized to pass through the annual requirement of 4,130,000 m³ of process water during full production (as specified by TT). KP has included a 20% design factor in the design flowrate to allow for operational flexibility.

The intake for the reclaim system includes a 29 HP vertical turbine submersible pump, located at the northeast corner of the PWP. A stand-by pump will be provided as back-up. The pump intake line will be installed down the slope of the pond.

A double-walled ND 450 mm DR21 HDPE pipeline conveys the flows from the PWP to the reclaim tank. The pipeline alignment crosses the main haul road to the mill site perimeter road, and will be anchored with earthen berms as required. The pipeline will discharge into the top of the reclaim tank at the mill site.

Plans and details of the pump system and pipeline alignment are shown on Drawings C6250, C6260, and C6270.

7 – NON-CONTACT WATER RESERVOIR

7.1 GENERAL

TRI will be required to obtain a water right for groundwater beneficially used in the milling process through the Department of Natural Resources (DNRC) groundwater appropriation permit. The consumptive use portion of the water right will be offset through a mitigation plan as required for groundwater rights within the Upper Missouri River Basin. The NCWR has been designed as a potential option for storing water for mitigation purposes.

The NCWR could be filled with approximately 360,000 m³ of water on an annual basis. This water would be discharged to the environment during periods of low flow to provide compensation for water consumed by the mine process. The water can be discharged from the NCWR impoundment to the downstream catchment as required. Existing surface flows will be diverted around the NCWR.

The water supply source for the NCWR will be defined in future design phases as part of TRI's mitigation plan. However, it is assumed at this stage of design that an HDPE pipeline will convey the flows from the water supply to the NCWR, as shown in Drawing C6400. The pipeline alignment will follow existing roads and pathways if available to simplify installation, and will be buried if necessary under or adjacent to public roads. The pipeline will be located on the side of the road which minimizes the number of road crossings, and anchored with earthen berms as required. The pipeline will discharge into the NCWR from a discharge point near the crest of the facility onto an erosion resistant rock fill apron, as shown in Drawing C6420.

7.2 EMBANKMENT FILL ZONES

The NCWR embankment will be constructed with general fill material sourced from the impoundment shaping of the CTF. The embankment is a homogeneous rockfill embankment. Aside from topsoil removal within the embankment footprint, no impoundment shaping will be completed for the NCWR as the basin will remain an unlined facility. The upstream face of the embankment will be lined with a 100 mil HDPE geomembrane to reduce seepage. The upstream and downstream faces of the embankment will be constructed to a 2.5H:1V slope to facilitate geomembrane placement and operational re-vegetation. The crest of the embankment will be 10 m wide to accommodate traffic and pipelines. The toe of the geomembrane will be tied into dense natural ground by an anchor trench. No surface excavation of the NCWR will be conducted, thus the groundwater table will not be encountered.

7.3 SPILLWAY CONFIGURATION

The consequences of failure for the NCWR is relatively low compared to other mine facilities, as described in Section 4.3. A spillway is included to prevent overtopping of the embankment and safely route the design storm event through the NCWR, and discharge it to the wetlands downstream (as it would were the NCWR not there). The spillway is sized for the 1 in 200 year 24 hour storm. HydroCAD, a storm water modeling platform, was used to model the contributing area in order to estimate the peak instantaneous discharge associated with the 1 in 200 year storm event that would report to the spillway. Attenuation of flood flows within the facility below the invert elevation of the spillway has been ignored to provide for a conservative approach.

The spillway will be constructed along the south side of the facility in natural topography at the abutment, as shown on Drawing C4004. The invert elevation will be 1,774.5 m, which is 2 m below the embankment crest elevation of 1,776.5 m. The maximum water level during the design storm event is 1,774.7 m, allowing 1.8 m of freeboard in the spillway. The outlet geometry is a trapezoidal weir with a base width of 1 m, maximum depth of 1.3 m, and side slopes of 2H:1V, as shown on Drawing C4005. The weir transitions into a trapezoidal channel with a base width of 1 m and depth of 1 m, which discharges into the natural channel downstream of the NCWR embankment. The spillway will be predominantly cut in rock and will be lined with riprap to prevent erosion of the channel bed during high flows.

7.4 SEEPAGE AND DISCHARGE MANAGEMENT

It is anticipated that there will be approximately 36,000 m³ of seepage and evaporation losses annually from the NCWR (after accounting for offsets from precipitation and run-off), equating to approximately 100 m³ per day. The average seepage rate will be lower as the NCWR drains and the head decreases.

Water will be pumped from the facility on an annual basis, as required to offset a portion of the mine site consumptive water use during periods of low-precipitation. A floating pump unit will be located near the crest of the NCWR, adjacent to the spillway, which will draw water from the base of the reservoir and discharge into the spillway. The rate of seepage from the NCWR will be monitored based on pond elevation and pumping rates will be adjusted as needed to ensure that the required volume of water is discharged from the NCWR on a seasonal and an annual basis.

The pump location and pipeline alignment are illustrated on Drawing C6430. Details of the NCWR Discharge System are shown on Drawing C6440.

7.5 RUNOFF DIVERSION

Runoff into the NCWR basin must be diverted around the facility and discharged to the environment. A diversion ditch will be constructed to direct surface flows around the south side of the NCWR. The diversion channel will connect to the NCWR spillway and water flow will discharge directly into the wetlands.

Since the project is located in the Upper Missouri River Basin, which is closed to new surface water appropriations, runoff into the NCWR basin must be diverted around the facility and discharged to the environment to comply with DNRCs water right permitting requirements.

A diversion ditch will be incorporated upstream of the NCWR to intercept runoff from the catchment and route it downstream of the NCWR embankment. The ditch is sized to safely convey the 1 in 100 year peak instantaneous discharge with 0.3 m of freeboard during the flood event. The base width of the ditch will be 1.0 m, with a depth of 1.15 m and sides slopes no steeper than 1V:1.5H.

Details of the runoff diversion channel are shown in Drawings C4006 and C4007.

8 – SEEPAGE AND STABILITY ANALYSES

8.1 STABILITY ANALYSES

Stability analyses of the CTF, PWP and NCWR embankments were completed to investigate stability under static and seismic loading conditions. The methodology and design criteria are presented below, with typical cross-sections and results.

8.1.1 Modelling Approach

The stability analyses were carried out using the limit equilibrium computer program SLOPE/W (Geostudio, 2012). This program uses a systematic search to obtain the minimum factor of safety from a number of potential slip surfaces. Factors of safety were calculated using the Morgenstern-Price Method.

8.1.2 Design Criteria

KP targeted a minimum factor of safety of 1.5 as the design criteria for the stability analyses, in accordance with MCA 82-4-3 design requirements. MCA 82-4-3 defines the minimum acceptable factor of safety under static loading conditions as 1.3 during construction, 1.5 for long-term operations closure, and 1.2 for post seismic scenarios. A factor of safety of 1.2 is acceptable for post-earthquake (seismic) loading conditions provided that the resulting embankment deformations or crest settlements are not large enough to cause a release of stored water or tailings, and that the overall stability and integrity of the embankment is maintained. The target factor of safety used by KP for the design of the Project facilities exceeds MCA 82-4-3 guidelines and is considered to be suitably conservative.

8.1.3 Material Strength Parameters

The material unit weights and effective strength parameters used in the analyses are provided in Table 8.1 and Table 8.2. These parameters are based on information collected during the 2015 site investigation completed by KP (KP Ref. No. VA101-460/03-1).

Table 8.1 Soil Strength Parameters

Material Type	Model	Unit Weight (kN/m³)	Undrained Shear Strength (kPa)
Fresh Shale Rockfill (Embankment Fill)	Shear/Normal Function (Lower Leps)	21	-
Tailings + 0.5-2% Additives	Mohr-Coulomb	22	45

NOTES:

- Additives to include cement, fly ash and/or slag.

Table 8.2 Rock Strength Parameters

Material Type	Model	Unit Weight (kN/m ³)	GSI	UCS (MPa)	m _i	D
Shale (Highly Weathered)	Generalized Hoek-Brown Criteria	22	30	10	6	0
Shale (Moderately Weathered)	Generalized Hoek-Brown Criteria	23	40	40	6	0
Shale (Fresh)	Generalized Hoek-Brown Criteria	24	50	50	6	0

8.1.4 CTF Stability Analyses

The factors of safety were evaluated for the following cases during steady-state conditions:

- End of Construction (static only).
- During Operations (static and seismic).
- Post-Closure (static and seismic).

The CTF stability analysis is based on the maximum cross section through the main (eastern) CTF embankment. Analyses were carried out for the following CTF embankment configurations:

- Final embankment (Crest El. 1,799 m, approximately 46 m high) with no tailings deposition and no retained water (upstream and downstream failure mode).
- Final embankment (Crest El. 1,799 m) with tailings deposition and storm storage up to El. 1,781 m (upstream and downstream failure mode).
- Final embankment (Crest El. 1,799 m) with full tailings and storm storage up to El. 1,797 m (downstream failure mode only).

The cross-section used in the CTF stability analyses is shown on Figure 8.1. The factors of safety for the CTF are shown on Table 8.3. The CTF embankment exceeds the factor of safety requirement for all cases modelled.

Table 8.3 Results of CTF Stability Analyses

Slip Surface Direction	End of Construction	Operating Conditions		Post-Closure	
	<i>No tailings</i>	<i>Tailings to El. 1,781 m</i>		<i>Tailings to El. 1,797 m</i>	
	Static	Static	Seismic	Static	Seismic
Required Minimum Factor of Safety	1.3	1.5	1.2	1.5	1.2
Upstream	2.5	2.5	1.6	n/a	n/a
Downstream	2.3	2.3	1.5	2.3	1.5

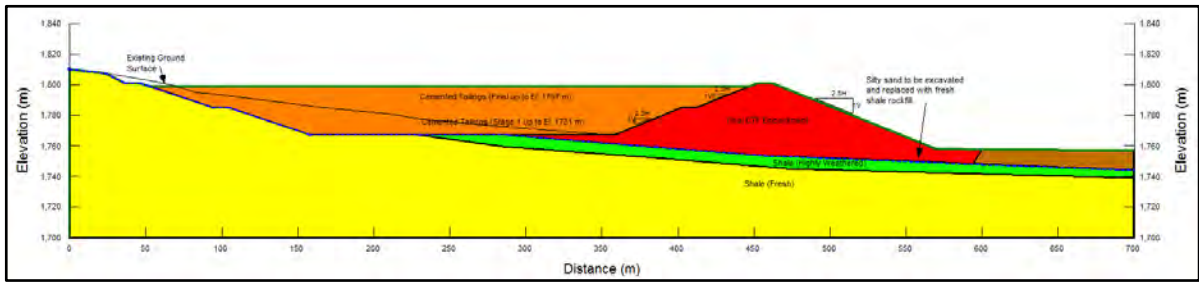

Figure 8.1 CTF Typical Cross-Section

8.1.5 PWP Stability Analyses

The following cases were evaluated for the PWP embankment:

- End of Construction (static and seismic).
- During Operations (static and seismic).

The stability analysis for the PWP was based on the maximum cross section through the northern PWP embankment. The analyses were carried out for the following configurations:

- Final embankment (Crest El. 1,800 m) with no retained water (upstream and downstream failure mode).
- Final embankment (Crest El. 1,800 m) with retained water up to El. 1,798 m (downstream failure mode only).

The cross-sections used in the stability analyses of the PWP are shown on Figure 8.2. The Factors of Safety for the PWP section are shown on Table 8.4. The calculated Factors of Safety for the PWP embankment exceed the minimum Factor of Safety requirements for short term and long term stability during steady-state conditions.

Table 8.4 Results of PWP Stability Analyses

Slip Surface Direction	End of Construction		Operating Conditions	
	Static	Seismic	Static	Seismic
Required Minimum Factor of Safety	1.3	1.2	1.5	1.2
Upstream	2.5	1.6	n/a	n/a
Downstream	2.5	1.6	2.5	1.6

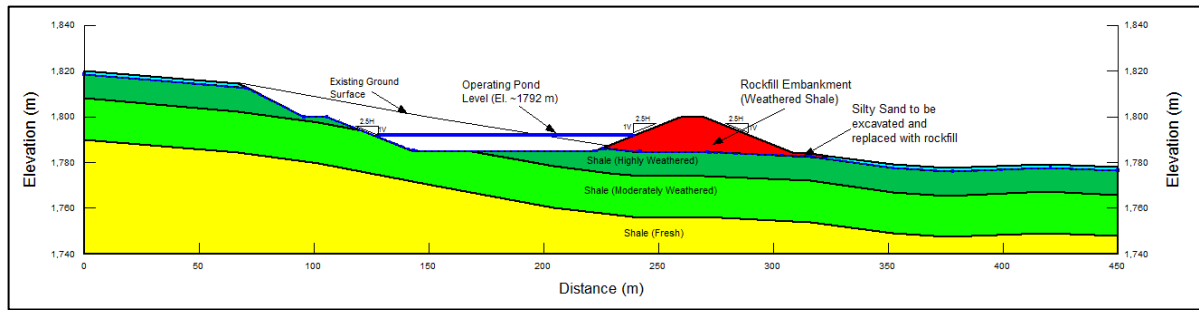

Figure 8.2 PWP Typical Cross-Section

8.1.6 NCWR Stability Analysis

The calculated Factors of Safety for the NCWR embankment exceed the minimum Factor of Safety requirements for short term and long term stability during steady-state conditions.

The following cases were evaluated for the NCWR embankment:

- End of Construction (static and seismic).
- During Operations (static and seismic).
- Rapid drawdown during Operations (static only).

The stability analysis for the NCWR was based on the maximum cross section through the NCWR embankment. The analyses were carried out for the following configurations:

- Final embankment (Crest El. 1,776.5 m) with no retained water to simulate end of construction conditions (upstream and downstream failure mode).
- Final embankment (Crest El. 1,776.5 m) with retained water up to El. 1,774.5 m to simulate operating conditions (upstream and downstream failure mode).
- Final embankment (Crest El. 1,776.5 m) with rapid drawdown of retained water to El. 1,764 m (over 24 hours) with buildup of excess pore pressures within NCWR embankment (upstream failure mode only).

The cross-sections used in the stability analyses of the NCWR are shown on Figure 8.3. The Factors of Safety for the NCWR section are shown on Table 8.4. The NCWR embankment exceeds the factor of safety requirement for all cases modelled.

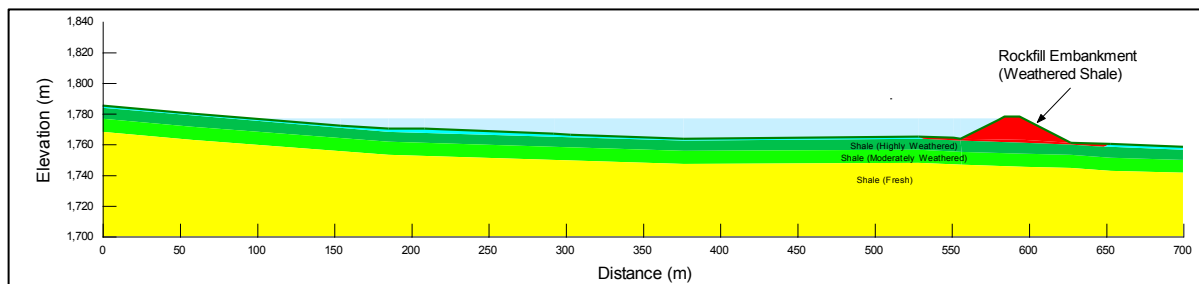

Figure 8.3 NCWR Typical Cross Section

Table 8.5 Results of NCWR Stability Analysis

Slip Surface Direction	End of Construction		Operating Conditions		Rapid Drawdown
	Static	Seismic	Static	Seismic	Static
Required Minimum Factor of Safety	1.3	1.2	1.5	1.2	1.1
Upstream	2.5	1.6	n/a	n/a	1.5
Downstream	2.5	1.6	2.0	1.3	n/a

8.2 SEEPAGE ANALYSES

This section provides a brief discussion on potential seepage rates during operations of the CTF, PWP and NCWR.

8.2.1 Modelling Approach

Seepage through the geomembrane liner systems of the CTF and PWP was modelled using both empirical seepage rate equations and numerical modelling. Empirical methods were based on Giroud and Bonaparte (1988) and numerical modelling was completed using the 2D finite element computer programme SEEP/W (Geostudio, 2012).

8.2.2 CTF and PWP Seepage Analyses

The lining system in both facilities will limit the majority of potential seepage from the facility to flow through potential defects in the geomembrane. Leakage through the lining systems was modelled using Giroud and Bonaparte leakage rate equations, which assume a number of defects per hectare for various geomembrane installation methods. This assessment was carried out to estimate potential leakage flow rates through the lined facilities during operations of the CTF and PWP.

The double-lined system of the CTF was modelled in two separate analyses. The first analysis evaluated seepage from the cemented tailings through the upper liner into the geonet. This seepage rate was estimated by modelling a vertical column that represents a unit area of the geomembrane with a single defect, tailings and ponded water. This scenario conservatively represents the CTF in a post storm event condition, where water will be temporarily stored within the CTF until it is pumped to the PWP. The seepage rate through the liner was calculated by multiplying the results of the model by the surface area of the CTF assuming a single 2 mm defect is present for every 0.4 hectares (1.0 acre) of geomembrane (Giroud & Bonaparte, 1989a & 1989b, and Giroud, 1997). The estimated potential seepage rate from the CTF to the geonet under the fully saturated condition modelled is approximately 2×10^{-7} m³/s or 16 L/day, however the CTF will be operated with a minimal volume of stored water so the actual seepage rate is anticipated to be negligible.

The analysis of the lower CTF geomembrane modelled the head pressures present between the upper and lower geomembrane (the thickness of the geonet) with defect density of two 2 mm defects per hectare of the geomembrane (US EPA, 1992). The estimated potential maximum seepage through the bottom geomembrane layer to the foundation drain is in the order of 3×10^{-6} m³/s, which exceeds the estimated seepage from the upper liner by an order of magnitude. Therefore, total potential seepage from the facility will be limited by the upper liner at a rate of 16 L/day, and even then only

under conditions where the CTF is inundated with water for a prolonged period of time. Seepage through the CTF Liner System will be collected in the CTF Foundation Drain (discussed in more detail in Section 5.5).

The double-lined system of the PWP was also modelled in two separate analyses. The first analysis modeled seepage through the upper geomembrane to the geonet layer, influenced by head pressure from the full column of pond water and assuming a defect density of one 2 mm defect per hectare (Giroud & Bonaparte, 1989a & 1989b, and Giroud, 1997). The analysis of the lower geomembrane modeled the head pressures present between the upper and lower geomembrane (the thickness of the geonet) with defect density of two 2 mm defects per hectare of the geomembrane (US EPA, 1992). The estimated potential seepage rate from the PWP to the geonet layer is approximately 6×10^{-4} m³/s, and seepage through the bottom geomembrane layer to the foundation drain is in the order of 3×10^{-7} m³/s to 1×10^{-6} m³/s, which equates to approximately 26 to 86 L/day. The foundation drain collection system will collect and transfer seepage from the PWP to a downstream collection pond for pumping to the PWP.

8.2.3 NCWR Seepage Analysis

The seepage analysis estimated the rate of water leakage from the NCWR through the topsoil and weathered bedrock along the impoundment foundation, in order to assess the need for alternative seepage control measures.

Two analyses were completed as follows:

- The embankment will overlie weathered bedrock with no seepage control measures aside from the HDPE liner on the upstream face of the embankment. The face liner will be anchored into dense ground.
- A grout cut-off will be included in the weathered bedrock along the upstream toe of the embankment.

It was determined that the rate of water loss to seepage and evaporation from the NCWR when at full capacity is approximately 36,000 m³ annually, or 100 m³ per day, of which approximately 90 m³ per day is attributed to seepage. The installation of a cut-off may not significantly reduce seepage rates out of the NCWR if head pressures from the overlying pond force water flow beneath the distal extent of the grout curtain.

The actual discharge rates and periods of active (vs. seepage) discharge from the pond will be controlled by water right requirements for surface water mitigation. These requirements are overseen and regulated through permitting by the Montana Department of Natural Resources and Conservation.

9 – CONSTRUCTION

9.1 GENERAL

Earthworks construction activities will include access/haul roads, borrow area preparation, borrow excavation, foundation preparation, subgrade preparation, embankment fill placement, liner bedding and transition filter material processing and placement, installation of the geotextiles and HDPE geomembranes throughout the basin footprints of the CTF, PWP and NCWR and installation of instrumentation. Additional construction activities will include installation of pumps and pipelines.

The embankments will be constructed with fill material excavated from the CTF and PWP basins as part of the cut-fill construction method and impoundment shaping. The majority of this fill is shale rockfill, with minor amounts of granodiorite rockfill and overburden. Haul roads connecting the CTF, PWP and NCWR will be constructed early on during the construction phase to provide access for the construction fleet. The CTF basin has been designed such that the CTF cut will provide supplementary construction material for the PWP and NCWR embankments.

It is anticipated that a contractor would be responsible for foundation preparation, basin shaping, liner bedding placement, geomembrane installation, and installation of instrumentation, sumps, pumps and pipelines. It is assumed that weathered bedrock excavated from the CTF and PWP basins will be used for liner bedding material. Sand and gravel used for construction of the CTF and PWP drainage sumps will need to be sourced from local borrow areas, or otherwise generated by selective crushing of fresh (unweathered) bedrock.

It is anticipated that construction of the waste and water management facilities will commence 18 to 24 months prior to production mining in year 2. The temporary waste rock pad and contact water pond will be constructed first in order to store waste rock produced during excavation of the mine adit. The PWP construction will be completed within 12 to 16 months after construction commences in order to store water pumped out of the underground mine workings beginning in Year 1. Completion of the basin floor of the CTF will be prioritized so that waste rock from the temporary pad can be used to construct the basin drain concurrently with construction of the remainder of the CTF.

Construction material specifications are presented in Drawing C0003. The grading plan, liner system layout plan, typical sections, and details for the CTF are illustrated on Drawing C2001 to C2011, for the PWP on Drawings C3001 to C3010 and for the NCWR on Drawings C4001 to C4007. Construction layouts and details for surface water management structures are shown on Drawings C5001 to C5006. Plans, sections, and details for tailings and water delivery pipeline and pump systems are presented on Drawings C6000 to C6520. The grading plan, liner system layout plan, typical sections, and details for the temporary waste rock storage pad are shown on Drawings C7001 to C7003.

9.2 FOUNDATION PREPARATION

Site investigations completed at the facilities were used to characterize the subsurface conditions and to estimate the foundation preparation requirements. Throughout the property, the area is characterized by a thin veneer of topsoil overlying weathered, rippable bedrock to depths ranging from 2 to 10 m.

The topsoil and sub-soil layers are typically 0.5 to 1.1 m thick, respectively, with an average combined thickness of 0.9 m based on recent March 2017 work by Westech Environmental Services, Inc.

(Westech, 2017). Topsoil is typically 0.3 m thick. Subsoil averages 0.6 m thick. These soil units will be stripped and stockpiled separately prior to foundation excavation and grading. The fresh bedrock is considered suitable for use as general fill material in embankments. Weathered bedrock and overburden will be excavated, separated, and selectively used for liner bedding or embankment fill.

9.3 BASIN EXCAVATION, SHAPING, AND SUBGRADE PREPARATION

Basin excavation and shaping activities will be carried out prior to or during Stage 1 construction. Basin and impoundment slopes will be prepared for geomembrane deployment following basin shaping activities. Crushed weathered bedrock and overburden will be utilized as fill for basin shaping, subgrade preparation and liner bedding.

The CTF and PWP basins will be graded in preparation for the installation of the geomembrane. This includes the ripping, drilling and blasting of bedrock (if required) and placement of fill in certain areas within the basin to achieve the grades and surfaces required for the installation of the geomembrane. The basins of both facilities will be graded prior to the start-up of the facility to avoid the risk of damaging portions of exposed geomembrane during ongoing work on the basin slopes.

It is anticipated that only the CTF cut will extend below the groundwater table. Erosion control and dewatering measures (including surface water diversions) will be implemented on an as needed basis to manage groundwater seepage into the construction site. The foundation drains will be installed in the CTF and PWP during this phase of construction. Sections of the foundation drains that underlie the embankments will be constructed first because the embankments will be constructed with material sourced from impoundment shaping. The foundation drain design will be modified based on observed water flows to maximize the collection capability of the system. The foundation drains for the CTF and PWP are illustrated on Drawings C2004 and C3004 respectively, with details provided on Drawings C2006 and C3008 respectively.

The footprint of the NCWR embankment will be stripped of topsoil/subsoil in preparation for construction of the lined embankment. No basin preparation is required as the basin itself will not be lined. The topsoil/subsoil from the embankment footprint will be stockpiled separately.

The CTF grading plan is illustrated on Drawing C2001, the PWP grading plan is illustrated on Drawing C3001, and the NCWR embankment grading plan is illustrated on Drawing C4001.

9.4 GEOMEMBRANE AND GEONET INSTALLATION

The 100 mil HDPE geomembrane will be placed over the entire basin footprints of the CTF and PWP, and on the upstream slopes of the CTF, PWP and NCWR embankments. The HDPE geomembrane panels will be welded together by thermal methods. All areas to be welded will be cleaned and prepared according to the approved procedures. Adequate temporary anchoring devices to prevent damage due to winds will be installed. Non-woven geotextile will be placed below and above the geomembrane to protect the geomembrane. The available wind speed data from site shows that, permanent ballast on the liner system will not be required.

The high drainage capacity geonet liner will be placed between the two HDPE geomembrane layers at the CTF and PWP. The geonet will be placed using approved methods and procedures that ensure minimum of handling, adequate temporary and permanent anchoring. Placement will be completed in

such a manner such that all primary flow paths through the geonet are unimpeded, which includes no driving of mine fleet over the geonet without adequate protective fill covering.

A primary objective of the Quality Assurance and Quality Control (QA/QC) procedures will be to minimize the potential for defects during construction. The operations and monitoring plan must also address the exposed geomembrane and identify actions required to repair any defects that occur during operations.

9.5 CTF BASIN DRAIN

The basin drain will be constructed above the HDPE geomembrane within the CTF basin. Non-woven geotextile will be placed over the floor of the CTF basin to provide abrasion protection of the geomembrane, and a protective layer of sub-grade bedding will be placed on top of the geotextile. Next, approximately 160,000 t of waste rock from pre-production will be removed from the temporary storage pad near the mine adit, hauled to the CTF basin and placed in layers to construct a drainage layer for the basin drain and facilitate movement of mine fleet traffic within the basin. The remaining 340,000 t (approx.) of waste rock may either be placed (without crushing and screening) over the basin drain to increase its thickness, as shown on Drawings C2008, or substituted for general rock fill to construct the CTF haul ramp. Waste rock may be also crushed and screened to construct the sub-grade bedding layer overlying the CTF HDPE lining system if required.

9.6 STOCKPILES

Organics and deleterious materials will be removed from the embankment and basin footprint areas and will be placed with the topsoil stockpiles outside of the final limits of the waste and water management facilities. Soils will be stored in separate stockpiles for topsoil and subsoil that will be used in closure. The material to be placed in these stockpiles will be used for future reclamation activities as required. However until such time, the outer surface will be graded and/or contoured to ensure adequate runoff characteristics and to minimize erosion potential. The stockpiled materials will be seeded and re-vegetated using native grasses to minimize run-off erosion and loss of material from wind erosion. Silt fences will be installed downstream as required to prevent release of sediment to the environment.

Excavated materials from the PWP and NCWR diversion channels and most of the other storm water diversion ditches will be placed adjacent to the diversion channel and temporarily reclaimed during construction with a revegetated soil cover, and both of these components will be used for final reclamation and closure. Excavated rock fill from the CTF diversion channel will be stored in reclamation material stockpiles for use in site-wide closure.

Oversize boulders from the CTF basin excavation will be separated and stockpiled for use as rip-rap in: the CTF, PWP, and NCWR diversion channels; in the NCWR spillway; and in stream crossings for roads.

9.7 MATERIAL QUANTITIES

The Stage 1 cut volume for the CTF will generate more fill than required for the construction of the PWP, NCWR, and Stage 1 CTF embankments. Excess cut material will be placed according to the embankment fill specifications on the embankment during the Stage 1 construction. Stage 2 construction will consist primarily of liner installation, as all embankment fill will be placed and

compacted during Stage 1. All opportunities for concurrent reclamation or revegetation will be completed as soon as practicable.

The PWP will be constructed to an approximate cut-fill balance and will only require minimal fill from the CTF cut. The NCWR embankment foundation preparation will involve stripping of topsoil, but because the NCWR will be unlined, no impoundment shaping will be required. Fill material for the NCWR will be sourced from the CTF cut.

Material used to construct the bedding layers and drainage sumps would be processed by the contractor using local borrow/quarry areas or suitable processed fill provided by the mine.

All liners and geosynthetics will be purchased as needed prior to construction and stored on site.

A summary of the cut-fill quantities required for construction and closure are presented in Table 9.1. A breakdown of the fill material and geosynthetics quantities required for the construction of the CTF, PWP and NCWR are summarized in Table 9.2. A bulking factor of 20% (after compaction) has been applied to the fill volumes, based on the average unit weight of 26 kN/m³ for the bedrock and an anticipated compaction density of 20 to 22 kN/m³.

For ongoing construction, the contractor will complete foundation preparation work, construct the remainder of the Stage 2 CTF embankment, and supply and install any additional required geosynthetics.

Table 9.1 Overall Cut and Fill Quantities

Activity	Cut Volume ⁽¹⁾ (m³)	Available Fill Material ⁽²⁾ (m³)	Total Fill Required (m³)	Recovered Materials at Closure ⁽³⁾ (m³)	Net Surplus Volume (m³)
Construction	2,498,000	2,448,000	2,200,000	-	248,000
Closure	0	0	408,000	160,000	-248,000
Total	2,498,000	2,448,000	2,608,000	160,000	0

NOTES:

1. The cut volume includes topsoil and subsoil volumes.
2. Available construction material assumes a 20% bulking factor for excavated materials.
3. Embankment fill volume totalling 160,000 m³ from NCWR (138,000 m³) and PWP (22,000 m³) will be recovered and used at closure for the CTF capping layer.
4. Available construction material volume utilizes subsoil (0.6 m) and topsoil (0.3 m) thickness estimates from Westech Environmental Services Inc. (2017).
5. The construction cut and fill volumes in this table include the following facilities: CTF, PWP, NCWR, WRS pad, diversion channels, and the foundation drains for the CTF and PWP.
6. The volumes of the materials listed in this table exclude pre-production waste rock.

It is anticipated that approximately 248,000 m³ of surplus fill material will be available at the end of construction that will be added to the fill stockpiles on site or used for construction of other mine site facilities as required. This surplus material on its own does not provide the fill volume required for closure. However, this deficit will be offset by utilizing embankment fill material from the NCWR deconstruction, supplemented by fill from the PWP deconstruction as needed. The cut fill balance of all facilities will be refined during future design phases.

Table 9.2 Construction Material Quantities for Primary Facilities

Material Type	CTF	PWP	NCWR	Temporary Waste Rock Pad	Total
Embankment Fill (m ³)	1,337,000	450,000	138,000	24,000	1,949,000
Sub-grade Bedding Placed Above Liner System (m ³)	44,000	-	-	20,000	64,000
Sub-grade Bedding Placed Below Liner System (m ³)	78,000	24,000	3,500	10,000	115,500
Drainage Gravel (m ³)	8,800	2,400	-	-	11,200
Filter Sand (m ³)	300	-	-	-	300
100 mil HDPE Geomembrane (m ²)	452,000	140,000	9,000	34,500	635,500
7.6 mm High Flow Geonet (m ²)	226,000	70,000	-	-	296,000
Non-woven Geotextile (m ²)	452,000	140,000	9,000	34,500	635,500

NOTES:

1. Construction material quantities are approximate, based on surface areas and volumes modelled in Civil 3D.
2. Construction material quantities do not include materials required for closure.
3. Smaller scale structures such as the diversion channels, or structures requiring embankment fill, sub-grade bedding, or drainage gravel less than 1,000 m³ in volume are not explicitly included.

9.8 INSTRUMENTATION

Instrumentation will be installed in the CTF, PWP and NCWR embankment fill zones and underlying foundations and monitored during construction and ongoing operations to assess performance and to identify any conditions which differ from those assumed during design and analysis. Amendments to the ongoing designs, operating strategies and/or remediation work can be implemented to respond to changing conditions, should the need arise. The following types of instrumentation will be installed:

- Vibrating Wire Piezometers - The basin drain and wet well sump and pump system in the CTF will be designed to minimize head on the impoundment liner. This will reduce the potential for seepage from the facility. Vibrating wire piezometers will be installed above the liner at select locations to measure the pore water pressures within the tailings and monitor the performance of the drainage management systems.
- Survey Monuments and Vibrating Wire Settlement Cells - Regular surveying will help evaluate the performance of the embankments with respect to movement, settling, etc. Survey monuments may be installed on the embankment crests following construction to monitor potential deflections along the slope and crest. Periodic surveying of the monument locations will provide early warning of

movements. Vibrating wire settlement cells may also be installed in the embankment fill and foundations.

- Inclined meters - Inclined meters installed at the embankments for the CTF, PWP and NCWR will provide additional detection and tracking of any subsurface movements. The inclined meters will be installed during construction, and be oriented to intersect critical slip surfaces as delineated in the stability analyses.

The instrumentation plans and details are shown on Drawings C2010 and C2011 for the CTF, on Drawing C3010 for the PWP, and on Drawings C4002 and C4003 for the NCWR.

10 – WATER MANAGEMENT

10.1 WATER BALANCE

A monthly operational water balance was prepared for the Project. The volume of water in the CTF, PWP and NCWR were estimated on a monthly basis in the model over 15 years, including 1 year for pre-production and 14 years of operations. Meteorological parameters for the model were developed using site specific data in conjunction with regional data as described in KP memo VA15-02445 (KP, 2015). The water balance model uses the determined mean monthly precipitation and evaporation values as inputs for each year. The mill requirements and outputs, along with miscellaneous freshwater requirements (truck wash, dust control etc.) were provided to KP by TT. The mill water requirements were provided as annual rates occurring when the mill is in full production.

The water balance results were calculated on a mean monthly basis as well as on an annual basis for each year. The scenario modelled includes a PWP start-up volume of 120,000 m³, with mean monthly precipitation conditions for the life of mine. Three separate scenarios were modeled using the life-of-mine water balance in order to obtain an understanding of the water requirements of the PWP during operations. The model was run deterministically for the mean case, and stochastically for the wet (95th percentile) and dry (5th percentile) cases. The estimated monthly volumes reporting to the proposed mine site, and the resulting effects on the volumes in the PWP, have been presented in terms of probabilities of occurrence for three scenarios:

- **Scenario 1 – Mean:** The results correspond to mean monthly climatic conditions.
- **Scenario 2 – 95th Percentile (Wet):** The results correspond to abnormally wet conditions, and represent the climatic conditions to be exceeded once every 20 years, on average.
- **Scenario 3 – 5th Percentile (Dry):** The results correspond to abnormally dry conditions, and represent the climatic conditions expected to be exceeded 19 years out of 20, on average (i.e. volumes will not exceed these values once every 20 years, on average).

The objective of the water management plan is to maintain a minimum monthly pond volume of approximately 120,000 m³ within the PWP, while not encroaching on the storm storage that will be maintained above a volume of 200,000 m³. Direct precipitation and run-off on the PWP facility is required to be pumped directly to the Water Treatment Plant (WTP) and released back into the watershed, therefore the PWP will be replenished as needed with water from the underground mine workings. No make-up water will be required in years 1 and 2 as ore processing in the mill is not anticipated to start until year 3.

The annual make-up water requirements and surface water transfer volumes for the mean, wet, and dry scenarios are presented in Table 10.1.

Table 10.1 Annual Make-Up Water Requirements

Year	Total Groundwater to PWP (m ³)	Surface Water Transfer from PWP to WTP (m ³)		
		Mean	Wet	Dry
1	0	0	0	0
2	0	0	0	0
3	109,000	107,000	227,000	32,000
4	142,000	110,000	231,000	35,000
5	178,000	110,000	232,000	34,000
6	181,000	110,000	232,000	34,000
7	184,000	110,000	230,000	35,000
8	181,000	110,000	234,000	34,000
9	188,000	110,000	235,000	35,000
10	193,000	110,000	232,000	35,000
11	190,000	110,000	233,000	34,000
12	186,000	110,000	232,000	34,000
13	185,000	110,000	230,000	34,000
14	141,000	110,000	231,000	34,000
15	56,000	110,000	232,000	35,000

It is necessary to supplement the PWP with make-up water from the underground source in order to achieve the design minimum pond volume based on the water balance and the conditions outlined in this letter. The results of the scenarios modeled are outlined below:

- All Scenarios - Average annual groundwater make-up required to sustain the minimum pond volume = 163,000 m³.
- Scenario 1 (Mean Conditions) - Average annual surface water volume transferred from the PWP to the WTP = 170,000 m³.
- Scenario 2 (Wet Year) - Average annual surface water volume transferred from the PWP to the WTP = 232,000 m³.
- Scenario 3 (Dry Year) - Average annual surface water volume transferred from the PWP to the WTP = 34,000 m³.

A detailed summary of the water balance is provided in Appendix D of this report. A schematic of the annual water balance (using the Year 6 – Mean Case as an example) is shown on Figure 10.1.

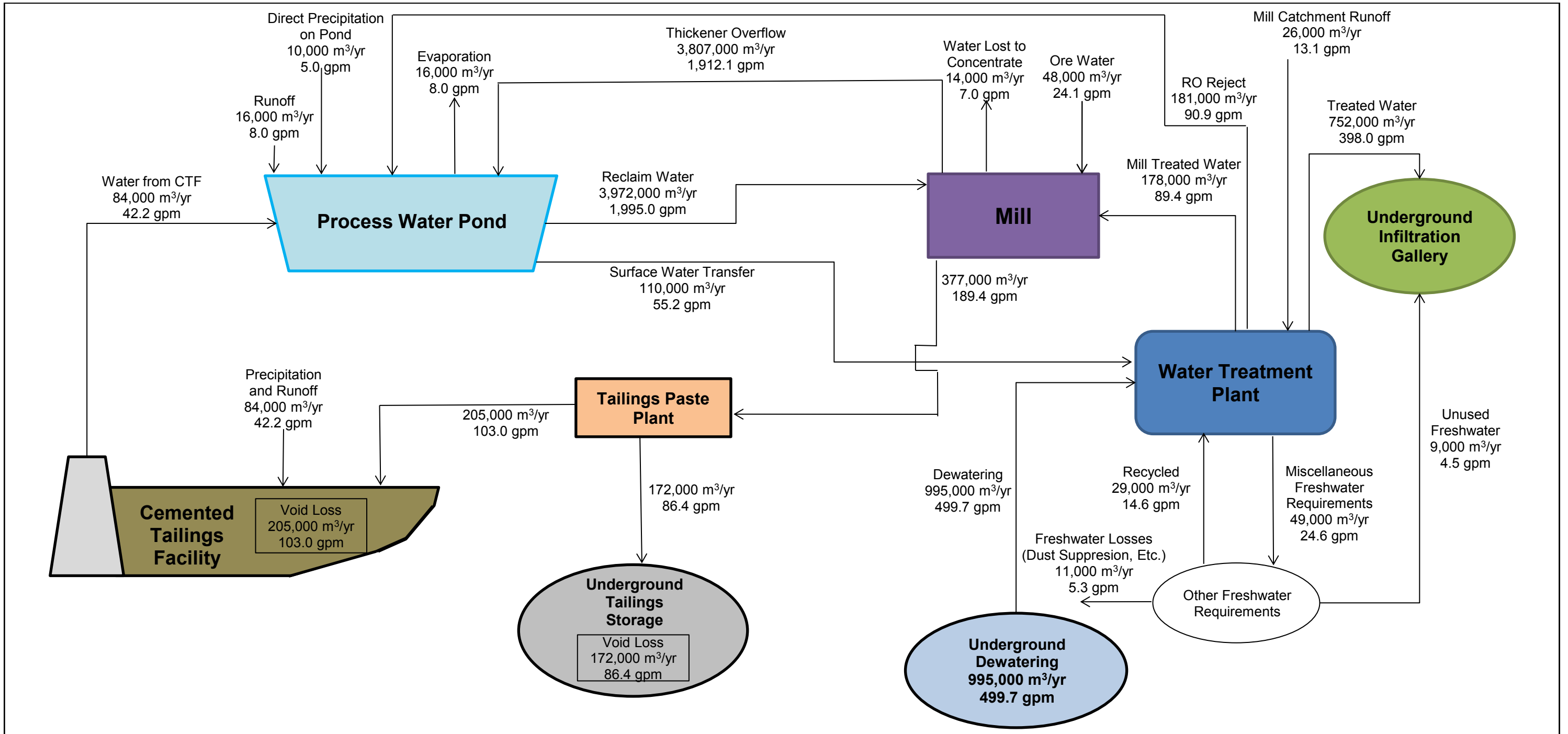

NOTES:
 1. ALL WATER VOLUMES ARE EXPRESSED IN UNITS OF CUBIC METRES PER YEAR AND GPM EQUIVALENTS.
 2. WATER IN TAILINGS PASTE IS ASSUMED TO BE UNRECOVERABLE.
 3. SEEPAGE IS ASSUMED TO BE ZERO AS THE FACILITIES ARE LINED.

TINTINA RESOURCES INC.	
BLACK BUTTE COPPER PROJECT	
ANNUAL WATER BALANCE SCHEMATIC MEAN CASE - YEAR 6	
<i>Knight Piésold</i> CONSULTING	P/A NO. VA101-460/3
	REF. NO. 2
FIGURE 10.1	
	REV 4

REV	DATE	DESCRIPTION	PREP'D	RVW'D
4	26APR'17	ISSUED WITH REPORT	BW	MH

10.2 STORM WATER MANAGEMENT

10.2.1 General

The 24 hour design storm events for the Project (at El. 1,737 m) are presented on Table 10.2.

Table 10.2 Storm Event Summary

Return Period (years)	24 Hour Storm Event (mm)
2	35
5	49
10	58
15	64
20	67
25	70
50	79
100	88
200	96
500	108

The probable maximum precipitation (PMP) event for the Project area is estimated to be 560 mm. The PMF is the result of the PMP (560 mm) combined with a 1 in 100 year snow accumulation (290 mm), resulting in a PMF of 850 mm of equivalent rainfall.

The Project facilities were designed for the PMF based on the high hazard potential classification, with the exception of the NCWR spillway, which was designed to safely pass a 1 in 200 year extreme rainfall event as previously described.

10.2.2 Surface Water Diversion Channels

The primary objective of the diversion channels is to maximize the collection of non-contact runoff from the catchments upstream of the CTF, PWP, and NCWR and convey it around these facilities for discharge to the downstream environment. The diversion channels reduce the amount of runoff contributing to the mine facilities by diverting their respective upstream catchments, which in turn reduces the storm water storage requirements, and reduces overall consumptive water use. Diversion of non-contact water also reduces flow impacts downstream of the Project.

All sections of the diversion channels for the CTF and PWP have been designed to carry the predicted peak flow generated during a PMF event. The diversion channel for the NCWR has been designed to carry predicted peak flow for a 1 in 100 year 24 hour storm event. HydroCAD was used to model the contributing areas in order to estimate the peak instantaneous discharge associated with the storm event that would report to the ditches.

The channels will be constructed with side slopes of 2H:1V. Excavated fill material will be placed alongside the channels as berms, or used as construction material along the fill sections of the diversion channels. It is currently assumed that the channels will be predominantly cut in rock and will need little erosion protection. Where erosion protection is required (e.g. sections of deep overburden

or filled downslopes) engineered soil stabilization (e.g. concrete filled or vegetated geocell products) or riprap will be used to prevent erosion of the channel bed during high flows. The base width of the various channel sections ranges from 1.0 m to 2.5 m, while the channel depth ranges from 1.2 m to 2.5 m. The channels were designed to maintain a 0.3 m freeboard during the storm event.

Steel pipe bridges will be constructed to allow tailings delivery and reclaim water pipelines to pass over the diversion channel.

An energy dissipation structure is included to reduce the runoff velocities and energy at the outlet of the diversion ditch. A spreading transition still basin was chosen as the design concept for the energy dissipater, which includes the following components:

- Spreading transition.
- Chute blocks at the entrance to the stilling basin.
- Basin blocks.
- End sill.

Construction details are illustrated on Drawings C5001 to C5004.

10.3 EROSION CONTROL BEST MANAGEMENT PRACTICES

Best Management Practices (BMPs) are incorporated to control erosion by stabilizing exposed soil or by reducing surface runoff flow velocities. There are generally two types of erosion control BMPs:

- Source control BMPs for protection of exposed surfaces.
- Conveyance BMPs for control of runoff.

Erosion control BMPs will be implemented prior to and during construction to minimize erosion and sediment discharge into surrounding areas. BMPs for erosion control include:

- **Vegetation Management and Re-vegetation:** Natural vegetation is one of the best and most cost effective methods of reducing the potential for erosion and sedimentation by keeping soil secure and providing ground cover to buffer raindrop impacts.
- **Mulching:** Application of a uniform protective layer of straw, wood fiber, wood chips, or other acceptable material on the soil surface of a seeded area allows for the immediate protection of the seed bed during re-vegetation. Mulching can be used in areas that require temporary or permanent covers.
- **Rolled Erosion Control Products:** Geosynthetic or organic materials composed of two layers of coarse mesh with a central layer of permeable fibres can be used to cover un-vegetated cut or fill slopes when vegetation or mulching alone is unsuccessful.
- **Slope Roughening:** Cut and fill slopes can be roughened with tracked machinery or other means to reduce run-off velocities, increase water infiltration rates, and helps facilitate future re-vegetation. It is simple, inexpensive and provides immediate short-term erosion control for bare soil where vegetative cover is not yet established.
- **Re-contouring:** This method can reduce the effect of erosion by shortening the length of the accumulation and movement of water as well as decreasing the overall slope angles. Re-contouring and slope roughening are beneficial as they are easily planned and constructed on site.
- **Silt Fencing:** This is a perimeter control BMP used to intercept sheet flow runoff in conjunction with other BMPs. Typical silt fencing comprises a geotextile fabric anchored to posts driven into

the ground and promotes sediment control by filtering water that passes through the fabric and increases short term retention time, allowing suspended sediments to settle. Silt fences will be placed parallel to slope contours in order to maximize ponding efficiency.

- **Temporary Sediment Traps and Sediment Basins:** A sediment trap/basin is a temporary structure used to detain runoff from small drainage areas (generally < 2 hectares) to allow sediment to settle out. A sediment trap/basin can be created by excavating a basin, utilizing an existing depression, or constructing a small dam on a slight slope downward from the work area.
- **Filter Bags:** Filter bags are generally constructed from a sturdy non-woven geotextile capable of filtering particles larger than 150 microns. Filter bags are typically installed at the discharge end of pumped diversions, via fabric flange fittings, to remove fine grained materials before discharging to the environment.
- **Flocculants:** Flocculation systems are installed in sediment control ponds and use chemical or natural additives (e.g. corn starch, chitosan, guar gum, etc.) to accelerate the natural settling process as sediment-laden water flows through the pond, and reduces the required pond retention time.
- **Collection Ditches:** A collection ditch intercepts contact water runoff from disturbed areas and diverts it to a stabilized area where it can be effectively managed. Coarse non-acid generating rock and equipment to build ditches and dams are easily obtained on site, and require little further maintenance, making them effective improvements.
- **Diversion Ditches:** Diversion ditches are constructed up-gradient of disturbed areas to intercept clean surface water runoff and discharge it through a stabilized outlet designed to handle the expected runoff velocities and flows from the ditch without scouring.
- **Culverts:** Culverts are used in tandem with collection or diversion ditches to pass water flow beneath disturbed areas, typically roadways, to prevent the erosion of these constructed structures.
- **Waterbars:** Waterbars serve to reduce sheet flow and surface erosion of areas of exposed soil and/or roads by diverting runoff towards a stable vegetated area or collection ditch. Waterbars may require regular maintenance when subjected to frequent traffic crossings.

Typical designs of several BMPs are illustrated on Drawings C5005 and C5006.

10.4 DAM BREACH INUNDATION STUDY

A dam breach inundation study was not completed as part of this design. Such a study will be completed as part of future design phases to be in compliance with MCA 82-4-3, if required pending the review of these designs by the independent engineering review panel.

11 – OPERATIONS AND MONITORING

11.1 GENERAL

Proper operation, monitoring and record keeping are a critical part of all waste and water management facilities. The requirements for proper operation and monitoring will be active and ongoing for the waste and water management systems described in this report.

A Tailings Operations, Monitoring and Surveillance (TOMS) Manual will be prepared separately for the waste and water management systems. This document will be reviewed and updated on an ongoing basis (i.e. during the initial construction program and operations). The TOMS Manual will outline regular monitoring, inspection and reporting requirements as well as emergency response measures in the event of upset operating conditions. The TOMS Manual should be referenced for all operations and monitoring activities relating to the CTF, PWP, NCWR and ancillary waste and water control structures.

General comments on operations and monitoring are provided below.

11.2 OPERATIONS

11.2.1 General

Activities to be carried out during operation of the CTF, PWP and NCWR will include monitoring and commissioning of the foundation drain, seepage collection and sump and pump systems, as well as construction/extension and management of tailings discharge pipeworks, basin drain, water reclaim systems and pipeworks and seepage recycle systems. In addition, concurrent reclamation of the downstream embankment slopes can be undertaken for all facilities following the completion of final embankment construction.

11.2.2 Tailings Delivery and Deposition

Tailings will be delivered at 79% solids content (approx. by weight) via pump and pipeline from the mill to the CTF. Tailings will be deposited using spigot offtakes positioned at the southern end of the CTF. Northward sloping beaches will be developed through selective spigot placement over the life of the mine that will direct surface water following precipitation events towards the wet well sump at the north end of the facility, the formation of a permanent pond on the surface of the CTF is not anticipated.

Details of the tailings delivery system are shown on Drawing C6100, and in Appendix E of this report.

11.2.3 Foundation Drains

The foundation drains will be constructed early and will become operational shortly after commencing construction of the CTF and PWP. Groundwater, meteoric water, and seepage infiltrating the foundations of the two facilities will be collected by the foundation drain and directed into the foundation drain collection ponds. Water will be pumped back from the ponds to the PWP or CTF respectively.

Water quality from the foundation drains will be tested on a regular basis by TRI to monitor the effectiveness of the CTF and PWP liners.

11.2.4 Basin Drain and Water Reclaim System

The CTF will be operated with a minimal pond, with temporary ponding of water following storm events. The basin drain will convey water that percolates through the tailings mass to the wet well sump and reclaim system, while surface water will report directly to the sump system. The reclaim pumps will be operated on an as-needed basis to transfer water from the CTF to the PWP for mill use.

Minor amounts of sediment may be transferred from the CTF to the PWP. Process water stored in the PWP will be monitored on a regular basis to ensure that adequate clarification of water is taking place prior to recycling for mill use.

11.3 MONITORING

Extensive monitoring will be undertaken as part of the ongoing operation of the facilities. Monitoring of the CTF, PWP, NCWR and ancillary works will provide important input for performance evaluation and refinement of operating practices. Complete details of the monitoring program will be included in a separate TOMS Manual that will be prepared for the waste and water management systems. Monitoring will be conducted throughout the life of the facility including construction, operation, decommissioning and post-closure.

The proposed monitoring falls into three basic types as follows:

- General Monitoring - This includes items such as tailings deposition locations, checks on pipe joints and pipe integrity, performance of pumps and valves, embankment freeboard, water levels in sumps and ponds, etc. Regular inspections will help identify any areas of concern that may require maintenance or more detailed evaluation. General monitoring will largely be undertaken through visual inspections carried out by designated personnel. Detailed inspection checklists, action sheets, and recording and reporting procedures will be developed for daily, weekly and monthly inspections.
- Performance Monitoring - This includes items such as:
 - Tailings solids content.
 - Tonnes of tailings deposited.
 - Groundwater monitoring well sampling and testing.
 - Analyzing piezometer levels within the tailings mass.
 - Analyzing settlement gauge data.
 - Analyzing inclinometer data.
 - Reviewing tailings level and density surveys.
 - Surveying the tailing beach slopes.
 - Confirming the supernatant pond volume.
 - Monitoring movement monuments.
 - Completing embankment surveys.
 - Water flow measurements.
- Water Quality and Compliance Monitoring – this includes items such as:
 - Ongoing baseline surface and groundwater flow and water quality sampling.
 - Facility water quality monitoring sampling.

A sampling and analysis plan for water quality and facility operational and closure compliance monitoring will be included in the Mine Operating Permit Application.

The monitoring program will be used to verify the performance of the facility, to refine future embankment raise levels, and to ensure that the project is meeting all its commitments with regards to operating a safe and secure facility. Monitoring of the waste and water management facilities will also provide performance evaluation information that will help refine operating practices.

12 – RECLAMATION AND CLOSURE

12.1 GENERAL

Reclamation and closure of the CTF, PWP and NCWR will be structured to meet the requirements of the Montana Metal Mine Reclamation Act. Reclamation of disturbed areas will be carried out during operations to the maximum extent practicable. The objectives of the reclamation plan are to return the site to pre-mining conditions and obtain all pre-mining beneficial land uses, which includes stabilizing disturbed areas to prevent soil loss, minimizing visual impacts, and preventing air and water pollution. This will be accomplished through surface drainage, progressive reclamation of downstream embankment slopes and interim revegetation of borrow areas using approved seed mixes. Final reclamation of the CTF, PWP and NCWR will include the following:

- **Dewatering:** Natural drying and evaporation will reduce the moisture content in the tailings, and reduce pond levels in the PWP and NCWR. Cement, fly ash or slag added to the tailings during thickening will stiffen the tailings after deposition and create a stable, non-flowable mass. At closure, all surface water will be pumped out of the CTF, PWP, and NCWR including their respective sumps and foundation drain collection ponds and treated at the on-site water treatment plant. Additional dewatering measures will be considered if required by site conditions at the time of closure. If any sediment is present in the PWP after draining, these sediments will be mixed with cement to create a hardened, non-flowable mass, the liner will be folded in upon itself and will be buried in place about 10 m (33 feet) below the final regraded surface and about 8 m (25 feet) above the regional groundwater table.
- **Shaping:** Shaping of the tailings surface may be required for closure. Shaping may be accomplished by selective tailings deposition or placement of general fill material to create a self-draining topographic surface suitable for capping and closure of the CTF.
- **Cover:** Sub-grade bedding material may need to be placed above the tailings and general fill to provide a protective layer for HDPE geomembrane placement, depending on the material that forms the final upper surface (i.e. not required for a smooth tailings surface).
- **Capping:** The CTF will be covered with a 100 mil HDPE geomembrane which will be connected to the existing liner system. The geomembrane cover will be capped off with non-reactive rockfill and overburden, which will be stockpiled during initial construction and operations, and graded to control runoff. The capping layer will be a minimum of 1,000 mm thick to comply with state guidelines for reclamation and closure, and will also serve to provide a stable platform for topsoil cover and revegetation. The cover material must be sized so that the geomembrane is not damaged during placement. Once the PWP is dewatered, the accumulated slimes will be mixed with cement and air dried, wrapped in the liner, and buried during final facility regrading. Embankment fill from the PWP will be used to bury the liner system. Because the PWP was constructed as a cut and fill material balance facility, there will be ample material to bury the liners during reclamation to a depth of 6 m (20 feet) or more using embankment materials. Remaining slopes will be contoured to resemble pre-mining conditions. The geomembrane liner systems for the NCWR and foundation drain collection ponds will also be removed and placed in the CTF for burial.
- **Embankment Excavation and Contouring:** The PWP and NCWR embankments will be deconstructed in order to restore the site to as close to the pre-mining conditions as possible. The exposed sections of the PWP foundation drain will be removed as the liner is folded in. Embankment fill from the PWP will be used to regrade the PWP footprint to resemble natural

topography, with some fill used to provide a capping layer for the CTF as needed. The majority of the NCWR fill will be hauled to the CTF for use as a capping layer, with some material left in place and regraded to resemble pre-mining conditions. Disturbed areas, except for the CTF footprint, will be contoured to resemble pre-mining conditions.

- **Revegetation:** Revegetation measures include soil replacement using the stockpiled topsoil, seedbed preparation and seeding with approved seed mixes. A soil cover of 700 mm thickness (180 mm topsoil and 520 mm sub-soil) will be placed over the regraded tailings and rockfill surface, as well as in mosaic patterns on the embankment slopes (internal and external). The soil cover will be revegetated with approved seed mixes, with revegetated slopes not exceeding 50 m in length before being interrupted by a rocky zone. These rocky zones will be placed asymmetrically across the slope.

Inactive borrow areas and stockpiles will be re-contoured, covered with topsoil and revegetated at closure.

Final reclamation of the facilities will include decommissioning of the foundation drain collection pond for the CTF and connecting the foundation drain outlet pipe to the underground infiltration gallery. The foundation drain collection ponds will have their liners removed and hauled to an off-site disposal or recycling center. All disturbed ground will be re-contoured and re-vegetated. The deactivated and reclaimed CTF, along with the CTF diversion channel will be the only remaining structures on site at the completion of the final reclamation phase.

12.2 POST-CLOSURE MONITORING

The goals of the reclamation plan for the waste and water management facilities are to achieve long term stability of each facility site or remaining embankment, to develop a self-sustaining productive vegetative cover over the tailings and synthetic liners, and to ensure long term protection of the surrounding environment. In order to document the success in achieving these goals, a post-closure monitoring program will be developed. The CTF is designed to be geotechnically stable at closure and the post-closure monitoring program will confirm the design performance. This monitoring program will include geotechnical monitoring, hydrogeological monitoring, re-vegetation monitoring, erosion control, and the continuation of approved water quality monitoring plans.

Geotechnical monitoring will include survey monuments on the crest and downstream slopes of all remaining embankments, as well as on fill material used to cap the CTF at closure. These monuments will require surveying at regular intervals in order to indicate any settlement or movement in the facilities. Inclinometer measurements will also be recorded simultaneously as part of the geotechnical monitoring program. Following closure, all monuments and inclinometers will be monitored until no noticeable additional settlement movement takes place within a 12-month period.

Additional monitoring will include the ongoing monitoring of the pore pressures within the basin drain, and wet well sump and pump system in the CTF. This will include monitoring of the vibrating wire piezometers installed during operations, as well as any others required at closure. The piezometers will be monitored regularly during operations and for a post-closure period until the reclamation has been deemed complete and the bond released.

During operations, a surface and groundwater quality monitoring program will be conducted in order to determine seasonal and temporal changes in the foundation drain flows and receiving water quality from the CTF and PWP. This program will be carried out to confirm compliance with downstream

receiving water quality requirements and to project changes in the groundwater quality over time. The program will consist of sampling and analyses of:

- Foundation drain flows from the CTF collection sump.
- Monitoring wells located throughout the mine site, especially those down gradient from the CTF.

The analyses will be as per the approved water quality monitoring plan, which is being developed by others for inclusion in the Mine Operating Permit Application. Monitoring conducted over the life of the mine will indicate whether any adverse impacts to the water quality have occurred during operations. Results of the water quality monitoring will be provided to the DEQ, who will determine whether down-sizing or cessation of the monitoring program is permissible. Provided that additional water quality monitoring is not warranted, the monitoring wells will be decommissioned by sealing the full length of the well with an inert cement grout and the casing will be cut off below ground level as per Montana well abandonment protocols and regulations.

13 – SUMMARY

Feasibility level designs have been prepared for the waste and water management facilities at the Black Butte Copper Project. The feasibility designs provide permanent and secure storage of cemented tailings, temporary storage during operations for process and contact water, and control of non-contact surface water.

The feasibility designs are based on a projected 15 year mine life at a processing rate of 3,300 tonnes per day and were developed concurrently with mine design and planning, using the PEA resource as the design basis. A total of 13.2 million tonnes of ore will be processed over the life of the mine; 45% of the tailings produced will be used for underground backfill and the remaining 55% will be stored on surface in the Cemented Tailings Facility (CTF). The CTF has been designed to store 3.56 million m³ of tailings at an averaged settled dry density of 2 t/m³, 0.35 million m³ of waste rock, with additional capacity for temporary storage of a Probable Maximum Flood event. A separate Process Water Pond (PWP) will store approximately 200,000 m³ of contact water for mill use recycle, with additional capacity for storm storage.

The main features of the waste and water management systems are as follows:

- Ultra-thickened (79% solids content) tailings, with 0.5-2% (by weight) cement, and fly ash or slag added, delivered by pipeline to the CTF, located south of the mill site. The cement and fly ash or slag additives will stiffen the tailings after deposition and create a non-flowable mass.
- Cemented tailings will be discharged using spigot offtakes at the south end of the impoundment. The offtakes will be repositioned as needed to ensure the development of northward sloping beaches. Bleed water and precipitation will be collected in a basin drain integrated with a wet well sump and pumped to the PWP for mill use. The tailings will be delivered to the CTF via insulated 8-inch diameter PN150 steel pipelines with an HDPE liner to provide corrosion protection. The pipelines will be double walled between the mill and CTF to provide containment in the event of a pipe leak. The pipelines will be flushed with water and drained when not in use.
- The CTF will be constructed with a single embankment to utilize the natural topographic containment located to the west. A cut-fill balance will be achieved through impoundment shaping to provide embankment fill material. The CTF will locally extend below the groundwater table elevation.
- The CTF will have a double liner system comprised of a 7.6 mm, high flow geonet layer sandwiched between layers of 100 mil HDPE geomembrane that encompasses the entire basin and on the upstream slope of the embankment. Potential seepage through defects in the upper geomembrane liner will be collected in the geonet and gravity-delivered to a sump and pump system to be pumped back into the CTF.
- The PWP will have a double liner system comprised of a 7.6 mm, high flow geonet layer sandwiched between layers of 100 mil HDPE geomembrane. Potential seepage through defects in the upper geomembrane liner will be collected in the geonet and gravity-delivered to a sump and pump system to be pumped back into the PWP.
- Foundation drains will be constructed beneath the CTF and PWP to collect groundwater flow and seepage beneath the impoundments and deliver it to foundation drain collection ponds for pump back to the respective facilities.
- A basin drain will be constructed in the CTF using waste rock generated during the pre-production year. This basin drain will allow the collection of tailings bleed water and maintain low head on the

geomembrane. It will convey any water that percolates through the tailings to the wet well sump and reclaim pump system.

- Reclaim water systems will be constructed at the CTF and PWP. The reclaim system will deliver water from the CTF to the PWP, and will be capable of removing water from a 1 in 100 year 24-hour storm event over a 10 day period. The reclaim system at the PWP will deliver water from the PWP to the mill reclaim water tank.
- A single embankment Non-Contact Water Reservoir (NCWR) will be constructed southeast of the project area. The NCWR will store surplus water that can be released back to Sheep Creek during the dry season to offset mine site consumptive water use.
- A water balance model developed for the facility indicates that the CTF and PWP will operate at a net water deficit during all years of operations, and only a portion of the process water requirements can be satisfied by water reclaim from the CTF. Additionally, precipitation and run-off into the CTF and PWP will be pumped directly to the WTP for treatment and release. Overall, approximately 163,000 m³ of make-up water is required annually to offset water losses to tailings voids, evaporation, and the diversion of precipitation and run-off.
- Instrumentation will be provided for all embankments, including vibrating wire piezometers, survey monuments, vibrating wire settlement gauges, and inclinometers. The instrumentation will be monitored as part of the detailed monitoring plans to be developed for the facility.
- The primary objective of reclamation and closure activities will be to ensure physical and chemical stability of the CTF, PWP and NCWR, and ensure that acceptable downstream water quality is maintained. Closure and reclamation will focus on removal of surface infrastructure (except for the CTF and the CTF diversion channel) and exposed liner systems, and covering all exposed tailings surfaces. Additional closure work will involve progressive reclamation and revegetation of the embankments and any other disturbed surfaces.

14 – REFERENCES

- Administrative Rules of Montana (ARM), Rule Chapter 36.14, Dam Safety. Available at:
<http://www.mtrules.org/gateway/ChapterHome.asp?Chapter=36%2E14>
Accessed April 2015.
- ADS, Inc., 2009. *Drainage Handbook – ADS N-12 ST IB Pipe (per ASTM F2648) Specification*. ADS, Inc., October 2009.
- ADS, Inc., 2015. *Technical Note 1.01 – Dual Wall Perforation Patterns*. ADS, Inc., January 2015.
- Bengston, H.H. 2014. *Spreadsheet Use for Partially Full Pipeline Calculations*. CED Engineering Professional Development Course.
- Berena, M., Pazmino, L. & Stark, T.D., 2010. *Subgrade Requirements for Fabricated Geomembranes*. Fabricated Geomembrane Institute at the University of Illinois at Urbana-Champaign, June 2010.
- Berglund, J., and McEldowney, R. 2008. *Montana Wetland Assessment Method*. Montana Department of Transportation, Environmental Services, Helena, Montana
- Bray, J.D. & Travararou, T., 2007, *Simplified Procedure for Estimating Earthquake-induced Deviatoric Slope Displacement*. doi 10.1061/(ASCE)1090-0241(2007)133:4(381).
- Duncan, J.M. et al, 2014. *Soil Strength and Slope Stability*.
- Federal Emergency Management Agency (FEMA). 2004. *Federal Guidelines for Dam Safety*.
- GEO-SLOPE International Ltd., Geostudio 2012 (Version 8.13). Calgary, Alberta.
- Giroud, J.P., Bonaparte, R., 1988. *Leakage through Liners Constructed with Geomembranes – Part 2. Composite Liners*. Geotextiles and Geomembranes (1989) Pg. 71-111.
- Giroud, J.P. & Bonaparte, R., 1989a. *Leakage Through Liners Constructed with Geomembranes – Part I – Geomembrane Liners*. Geotextiles and Geomembranes, Volume 8, pp. 27-67.
- Giroud, J.P. & Bonaparte, R., 1989b. *Leakage Through Liners Constructed with Geomembranes – Part II – Composite Liners*. Geotextiles and Geomembranes, Volume 8, pp. 71-111.
- Giroud, J.P., 1997. *Equations for Calculating the Rate of Liquid Migration Through Composite Liners Due to Geomembrane Defects*. Geosynthetics International, Volume 4, Nos. 3-4, pp. 335-348.
- GSE Environmental, 2014a. *GSE HD Textured Geomembrane Product Data Sheet*. Available at:
http://www.gseworld.com/content/documents/datasheets/membranes/North_America/HD_Textured_Geomem_METRIC_DS.pdf. Accessed May 2015.
- GSE Environmental, 2014b. *GSE TRxNet Geonet Product Data Sheet*. Available at:
http://www.gseworld.com/content/documents/datasheets/Bi-Planar/TRxNet_Geonet_METRIC_DS.pdf. Accessed May 2015.
- Hydrometrics, 2017, Appendix B: Baseline Water Resources Monitoring and Hydrogeologic Investigations Report, *in* Mine Operating Permit Application (Revision 1) submitted to the Montana Department of Environmental Quality on September 2016, Tintina Resources, Black Butte Project, August 2015, revised 2017, 58 pages.

- International Commission on Large Dams (ICOLD). 1989. *Selecting Seismic Parameters for Large Dams: Guidelines*. Bulletin 72.
- International Commission on Large Dams (ICOLD). 1989. *Tailings Dam Safety: Guidelines*. Bulletin 74.
- International Commission on Large Dams (ICOLD). 1992. *Selection of Design Flood: Current Methods*. Bulletin 82.
- International Commission on Large Dams (ICOLD). 1995. *Tailings Dams and Seismicity: Review and Recommendations*. Bulletin 98.
- International Commission on Large Dams (ICOLD). 1996. *A Guide to Tailings Dams and Impoundments*. Bulletin 106.
- International Commission on Large Dams (ICOLD). 2010. *Selecting Seismic Parameters for Large Dams: Guideline*. Bulletin 72, 2010 Revision. Bulletin 148.
- International Metallurgical and Environmental Inc., 2015, Tailings gradation curve from average values from lab test results, October, 2015.
- Jensen Control Engineering Systems, 2015. *Wet Well Design Guidelines*. Available at: <http://www.jensenengineeredsystems.com/category/wet-wells>. Accessed May 2015.
- Knight Piésold Ltd., 2015a. *Black Butte Copper Project Meteorology Data Analysis Update*. KP Reference VA15-02445, Issued May 27, 2015.
- Knight Piésold Ltd., 2015b. *Life of Mine Water Balance*. KP Reference VA15-03200, Issued October 7, 2015.
- Knight Piésold Ltd. (KP), 2015. *Black Butte Copper Project – 2015 Geotechnical Site Investigation Report*. Vancouver. Ref. No. VA101-460/3-1, Rev A.
- Knight Piésold Ltd. (KP), 2005. *Stillwater Mining Company Summary of Paste Tailings Trial Program and Precedent Practice Review*. Vancouver. Ref. No. VA101-110/2-2, Rev 0.
- Leps, T.M., 1970. *Review of Shearing Strength of Rockfill, Journal of the Soil Mechanics and Foundations Division*. Vol. 96, pp 1159-1170.
- Makdisi, F.I., and Seed, B.H., 1977, *A Simplified Procedure for Estimating Earthquake-Induced Deformations in Dams and Embankments*. Earthquake Engineering Research Center Report No. UCB/EERC-77/19, University of California, Berkeley, California.
- MG Engineering, 2016. *Black Butte Tailings Pipeline Feasibility Study*. MG Project No. 147315, Project Memorandum 001 Revision 01, February 23, 2016.
- Newmark, N.M., 1965, *Effects of Earthquakes on Dams and Embankments*. Vol. 15 No. 2 pp 139 – 159.
- Swaigood, J.R., 2003, *Embankment Dam Deformations Caused by Earthquakes*. 2003 Pacific.
- Stark, T.D & Villarreal, R., 2014. *Guidelines for Installation of Factory Fabricated Heavyweight Geomembranes*. Fabricated Geomembrane Institute at the University of Illinois at Urbana-Champaign, prepared for the International Association of Geosynthetic Installers (IAGI), March 2014.

Tintina Resource Inc., *Updated Technical Report and Preliminary Economic Assessment for the Black Butte Copper Project*, Montana Document No. 1391880100-REP-R0004-01.1, July 12 2013.

United States Army Core of Engineers, Regulation No. ER-1110-2-1806 "*Earthquake Design and Evaluation for Civil Works Projects*", July 31, 1995.

US Dept. of Agriculture, 1994, *National Engineering Handbook: Chapter 26 – Gradation Design of Sand & Gravel Filters*. National Resources Conservation Centre, October 1994.

US EPA, 1992. *Action Leakage Rates for Leak Detection Systems*. United States Environmental Protection Agency, Office of Solid Waste, EPA 530-R-92-004, January 1992.

Westech Environmental Services, Inc., 2017, Updated Soil Salvage Volumes for the Black Butte Copper Project, Montana, internal table (7-2) completed for Tintina Resources, Inc. and incorporated into the Mine Operating Permit Application submitted to the Montana Department of Environmental Quality, March, 2017.

Whitehall Geogroup Inc., *Quaternary Faulting Potential*, June 22, 2017

15 – CERTIFICATION

This report was prepared and reviewed by the undersigned.

Prepared:



Greg Magoon, P.Eng.
Project Engineer

Reviewed:



Ken Embree, P.Eng.
Managing Principal, Vancouver

Reviewed:



Ken Brouwer, P.Eng.
President



This report was prepared by Knight Piésold Ltd. for the account of Tintina Resources Inc. Report content reflects Knight Piésold's best judgement based on the information available at the time of preparation. Any use a third party makes of this report, or any reliance on or decisions made based on it is the responsibility of such third parties. Knight Piésold Ltd. accepts no responsibility for damages, if any, suffered by any third party as a result of decisions made or actions based on this report. Any reproductions of this report are uncontrolled and might not be the most recent revision.

Approval that this document adheres to Knight Piésold Quality Systems: 

APPENDIX A

DESIGN BASIS

(Pages A-1 to A-3)

TABLE A.1
TINTINA RESOURCES INC.
BLACK BUTTE COPPER PROJECT
FEASIBILITY DESIGN REPORT
SUMMARY OF DESIGN BASIS FOR THE CTF

Print: Apr/20/2017 13:46:09

ITEM	VALUE	SOURCE (Assumption if none noted)	DATE	Entered By:
1.0 GENERAL				
Site Coordinates	Approximately 506 000 E, 5 181 000 N (UTM NAD 83 Zone 12 N (Lat: 46.78°, Long: -110.92°))	Google Maps	28-Apr-15	GIM
Site Elevation	Approximately 1700 to 1840 masl	10 m Topography from TRI	28-Apr-15	GIM
Codes and Standards	SB 409, ASTM, ICOLD (1989 - 2010), FEMA (2004), Administrative Rules of Montana (2012) and related codes.	Various Sources	4-May-15	JEF
	Reclamation plan structured around the requirements of the Montana Metal Mine Reclamation Act		14-May-15	GIM
Mine Production	Total ore milled = 13.2 million tonnes (Mt)	TRI	10-Oct-15	GIM
	Throughput = 1000 to 3 300 tonnes per day, with peak production during Years 5 to 13 of operations.	TRI	10-Oct-15	GIM
	Tonnes Concentrate Extracted from Ore = 1.41 Mt	TRI	10-Oct-15	GIM
	Operating Mine Life = approximately 15 years	TRI	10-Oct-15	GIM
Climate Conditions	Mean Annual Precipitation = 416 mm	Knight Piésold Preliminary Hydromet Analysis	6-May-15	JEF
	Mean Annual Pond Evaporation = 514 mm	Knight Piésold Preliminary Hydromet Analysis	6-May-15	JEF
	Mean Annual Temperature = 1.9 °C	Knight Piésold Preliminary Hydromet Analysis	14-May-15	JL
	Site Runoff Coefficient = 0.2	Assumed value	6-Aug-15	GIM
	Mean Annual Wind Speed = 2.6 m/s	Western Regional Climate Center Record, Bozeman MTU station	28-Apr-15	GIM
	1 in 2 year 24 hour precipitation = 35 mm	Knight Piésold Preliminary Hydromet Analysis Work file #14 (VA101-460/3)	6-Oct-15	GIM
	1 in 5 year 24 hour precipitation = 49 mm	Knight Piésold Preliminary Hydromet Analysis Work file #14 (VA101-460/3)	6-Oct-15	GIM
	1 in 10 year 24 hour precipitation = 58 mm	Knight Piésold Preliminary Hydromet Analysis Work file #14 (VA101-460/3)	6-Oct-15	GIM
	1 in 15 year 24 hour precipitation = 64 mm	Knight Piésold Preliminary Hydromet Analysis Work file #14 (VA101-460/3)	6-Oct-15	GIM
	1 in 20 year 24 hour precipitation = 67 mm	Knight Piésold Preliminary Hydromet Analysis Work file #14 (VA101-460/3)	6-Oct-15	GIM
	1 in 25 year 24 hour precipitation = 70 mm	Knight Piésold Preliminary Hydromet Analysis Work file #14 (VA101-460/3)	6-Oct-15	GIM
	1 in 50 year 24 hour precipitation = 79 mm	Knight Piésold Preliminary Hydromet Analysis Work file #14 (VA101-460/3)	6-Oct-15	GIM
	1 in 100 year 24 hour precipitation = 88 mm	Knight Piésold Preliminary Hydromet Analysis Work file #14 (VA101-460/3)	6-Oct-15	GIM
	1 in 200 year 24 hour precipitation = 96 mm	Knight Piésold Preliminary Hydromet Analysis Work file #14 (VA101-460/3)	6-Oct-15	GIM
	1 in 500 year 24 hour precipitation = 108 mm	Knight Piésold Preliminary Hydromet Analysis Work file #14 (VA101-460/3)	6-Oct-15	GIM
	1 in 100 year snowpack = 290 mm	Knight Piésold Work File #10 (VA101-460/03)	15-May-15	JL
	Probable Maximum Precipitation 24 hour precipitation = 560 mm	Knight Piésold Work File #14 (VA101-460/03)	26-May-15	GIM
	Probable Maximum Flood 24 hour storm event = 850 mm	Knight Piésold Work File #15 (VA101-460/03)	26-May-15	GIM
Dam Hazard Classification	Dam Hazard Classification of "HIGH" in compliance with State, Federal and International Dam Safety Guidelines.	FEMA, ICOLD, State of MT	4-May-15	GIM
Geology	Ore deposit hosted in Newland Formation shale (Proterozoic calcareous shale)	Tintina Resources Inc.	6-Aug-15	GIM
Seismic Design Parameters	Operating Basis Earthquake (OBE) = 1/22 year earthquake event	Knight Piésold Work File #9 (VA101-460/03)	6-Aug-15	GIM
	Maximum Design Earthquake (MDE) = 1/10,000 year earthquake event	Senate Bill 409, Knight Piésold Work File #44 (VA101-460/03)	9-Oct-15	GIM
	Earthquake Design Ground Motion (EDGM) = 0.35 g	Knight Piésold Work File #44 (VA101-460/03)	6-Oct-15	GIM
2.0 MINE WASTE MANAGEMENT				
2.1 Waste Properties				
Tailings	Total tailings production = 13.2 Mt	TRI	28-Apr-15	GIM
	Dry density = 2.0 t/m ³	Tailings lab testing by KP	28-Apr-15	GIM
	55% stored in surface tailings facility, and 45% pumped underground as paste backfill.	AMEC Preliminary Underground Backfill Plan	28-Apr-15	GIM
	Specific Gravity of Solids = 3.77	SG Value provided by TRI sub-consultant Jeff Austin (2015)	28-Apr-15	GIM
	Single tailings stream (79% solids by weight)	TRI	6-Oct-15	GIM
	Tailings thickened and mixed with 0.5-2% cement, fly ash, or slag.	TRI	6-Oct-15	GIM
Potentially Acid Generating (PAG) Waste Rock	PAG co-disposed with tailings = 0.7 Mt	TRI	12-May-15	GIM
	All waste rock on surface to be disposed in the CTF.	TRI	28-Apr-15	GIM
	0.5 Mt of PAG Waste Rock generated during pre-production years.	Estimate based on AMEC mine plan	6-Aug-15	GIM
	Compacted dry density of waste rock = 2.0 t/m ³		28-Apr-15	GIM
	Specific Gravity of Waste Rock = 2.0 t/m ³		14-May-15	GIM
	Waste Rock to be placed in temporary waste rock pad during Construction and moved into CTF basin prior to mill start-up.		28-Apr-15	GIM
Topsoil	'A' and 'B' Horizons from topsoil and overburden stripping activities to be stockpiled separately for use in reclamation.	Geomin Resources Inc.	23-Feb-17	GIM
	'A' Horizon = top soils, average thickness of approximately 0.3 m across project site.	Geomin Resources Inc.	23-Feb-17	GIM
	'B' Horizon = subsoils, average thickness of approx. 0.6 m across project site, beneath 'A' Horizon.	Geomin Resources Inc.	23-Feb-17	GIM
	0.9 m topsoil depth assumed for material volume calculations	Geomin Resources Inc.	23-Feb-17	GIM
2.2 Cemented Tailings Facility (CTF)				
Function	The impoundment provides for secure long term storage of approximately 3.56 Mm ³ tailings and 0.35 Mm ³ PAG waste rock, and 0.3 Mm ³ of stormwater storage (4.21 Mm ³ total)	Based on TRI production schedule provided October 2015	9-Jul-15	GIM
Concept	55% of total tailings storage codisposed with 0.7 Mt of PAG waste rock within an impoundment formed by a single embankment. Embankment raised in stages and constructed using the downstream method. A HDPE (100 mil) lined impoundment, developed in stages throughout mine life.		6-May-15	GIM
Storage Capacity	Starter impoundment sized for containment of tailings up to year 4 of operations (including two years pre-production to contain Waste Rock produced). Assume embankment constructed using infill borrow from impoundment shaping.		28-Apr-15	GIM
	Staged expansion of the impoundment to provide for ultimate storage capacity.		28-Apr-15	GIM
	Ultimate Embankment at Closure - 55% tailings production and co-disposed waste rock plus storage and freeboard to attenuate IDF.		28-Apr-15	GIM
Dam Hazard Classification	'HIGH' as per FEMA, ICOLD and State of Montana Dam Safety Guidelines.	FEMA, ICOLD, State of MT	4-May-15	JEF
Inflow Design Flood (IDF)	Probable Maximum Flood (PMF), as per FEMA and ICOLD guidelines.	FEMA, ICOLD	4-May-15	JEF
Flood Management - Catchment Areas	Catchment Area = approximately 35.49 ha	Determined using currently facility and diversion channel layout	14-May-15	GIM
Inflow Design Flood (IDF) Volumes	0.30 Mm ³ (based on catchment area and 850 mm IDF runoff depth)		14-May-15	GIM
Design Freeboard	Minimum 2 m freeboard.		6-Aug-15	GIM
Embankment Slopes	2.5H:1V Side Slopes		6-Aug-15	GIM
Embankment Height	Maximum height of 46 m	Measured from the highest downstream slope	6-Aug-15	GIM
Basin Grading	Minimum 0.5% to facilitate drainage to water reclaim system and seepage collection sump		29-May-15	GIM
Operational Criteria	Flood management: Precipitation and bleedwater are directed to water reclaim system by selective tailings deposition and basin grading.		28-Apr-15	GIM
	Tailings ultra-thickened with cement and fly ash added to create non-flowable tailings.		6-May-15	GIM
	Mine water pumped to PWP.		28-Apr-15	GIM
	Minimal recovery from bleeding of tailings mass.		28-Apr-15	GIM
	Excess water monitored and treated accordingly.		28-Apr-15	GIM
Closure Criteria	Fill will be placed over the tailings and waste rock to create a level surface. The impoundment will be capped by a non-permeable liner and covered with a minimum 1 m thick layer of non-PAG fill material. Diversion channels will be maintained to direct surface water around CTF.		28-Apr-15	GIM
	The capping layer and downstream embankment slopes are to be covered with a minimum of 12 inches of topsoil from stockpiles and revegetated with an appropriate seed mix of local grasses and plants		6-Oct-15	GIM
	The foundation drain system will be maintained to collect seepage. Seepage water will be monitored and treated as needed.		6-Oct-15	GIM
Seepage	Seepage will be controlled through the use of: -HDPE geomembrane to minimize seepage from impoundment. -Foundation drain system.		29-May-15	GIM
	Collected seepage is monitored and pumped to PWP and recycled for mill use.		28-Apr-15	GIM
Seismic	Peak horizontal ground acceleration = 0.35 g (mean hazard value) (MDE)	Knight Piésold Work File #44 (VA101-460/03)	6-Aug-15	GIM
	Earthquake Design Ground Motion (EDGM) = 1/10,000 year event (MDE)	Senate Bill 409, Knight Piésold Work File #44 (VA101-460/03)	6-Aug-15	GIM
Embankment Stability	Permanent embankment slopes to be no steeper than 2.5H:1V to facilitate reclamation, and achieving the minimum required Factors of Safety (FOSmin) for the following loading conditions: Evaluated based on site investigation data, laboratory testing of representative samples, and staged embankment configuration		6-Aug-15	GIM
	During construction (starter dam and dam raises)	FOSmin = 1.3	Senate Bill 409	6-Aug-15
	Normal Operating Conditions	FOSmin = 1.5	Senate Bill 409	6-Aug-15
	Seismic (Post-earthquake loading condition; full liquefaction of tailings)	FOSmin = 1.2	Senate Bill 409	6-Aug-15
Embankment Crest Width	Minimum 10 m at closure to provide suitable running width for haul trucks, pipelines, and for potential future raises. Minimum 10 m working surfaces during downstream steps.		28-Apr-15	GIM
			6-Aug-15	GIM
2.3 Process Water Pond (PWP)				
Function	The PWP is designed for storage of 420,000 m ³ of process and stormwater.	1 year of process water storage requirement = 200,000 m ³ , plus an additional 220,000 m ³ for stormwater storage.	14-Jul-15	GIM
Concept	A double HDPE (100 mil) lined impoundment with geotextile barrier between layers of HDPE liner, constructed during pre-production years to contain process water for mill use recycle with additional capacity for storm event storage. Underlay liner and geotextile will collect and drain off leakage from overlay liner.		28-Apr-15	GIM
Storage Capacity	Impoundment of a minimum of 4 months of process water, storm water event water, and surplus to offset evaporation. Water volumes include 200,000 m ³ of process water for mill use recycle, water from CTF (60,000 m ³) and PMF event storage (160,000 m ³).		6-Aug-15	GIM
Dam Hazard Classification	'HIGH' as per FEMA, ICOLD and State of Montana Dam Safety Guidelines.	FEMA, ICOLD, State of MT	4-May-15	JEF
Inflow Design Flood (IDF)	Probable Maximum Flood (PMF), as per FEMA and ICOLD guidelines.	FEMA, ICOLD	4-May-15	JEF
Flood Management - Catchment Areas	Catchment Area = approximately 19.03 ha	Determined using currently facility and diversion channel layout	14-May-15	GIM
Inflow Design Flood (IDF) Volumes	0.16 Mm ³ (based on catchment area and 850 mm IDF runoff depth)		14-May-15	GIM
Design Freeboard	Minimum 2 m with additional freeboard for full containment of IDF for both CTF & PWP, and wave run-up.		6-Aug-15	GIM
Embankment Slopes	2.5H:1V Side Slopes		6-Aug-15	GIM
Operational Criteria	Flood management: PWP will be sized to store IDF, surface water will be redirected around facilities by diversion channels.		28-Apr-15	GIM
	Mine water pumped to PWP.		28-Apr-15	GIM
	Excess water monitored and treated accordingly.		28-Apr-15	GIM
Closure Criteria	The pond will be drained off and process water will be treated before release back into water system. Residual slimes within the impoundment will be mixed with cement. The HDPE liner system will be folded into the basin of the impoundment and buried. The disturbed area will be contoured to resemble the surrounding topography and covered with topsoil and revegetated.		14-May-15	GIM
Seepage	Seepage will be controlled through the use of: - Double lined facility consisting of 100 mil HDPE geomembrane with geotextile sandwiched between liners to collect and drain off leakage from upper liner.		28-Apr-15	GIM
	Collected seepage is monitored and pumped to PWP and recycled for mill use.		28-Apr-15	GIM
Seismic	Peak horizontal ground acceleration = 0.35 g (mean hazard value) (MDE)		6-Aug-15	GIM
	Earthquake Design Ground Motion (EDGM) = 1/10,000 year event (MDE)		6-Aug-15	GIM
Embankment Stability	Permanent embankment slopes to be no steeper than 2.5H:1V to facilitate reclamation, and achieving the minimum required Factors of Safety (FOSmin) for the following loading conditions: Evaluated based on site investigation data, laboratory testing of representative samples, and staged embankment configuration		6-Aug-15	GIM
	End of construction (starter dam and dam raises)	FOSmin = 1.3	US Army Corps of Engineers, 2003 guidelines	6-Aug-15

TABLE A.1
TINTINA RESOURCES INC.
BLACK BUTTE COPPER PROJECT
FEASIBILITY DESIGN REPORT
SUMMARY OF DESIGN BASIS FOR THE CTF

Print: Apr/20/2017 13:46:09

ITEM	VALUE	SOURCE (Assumption if none noted)	DATE	Entered By:
Embankment Crest Width	Long term (at closure)	FOSmin = 1.5	US Army Corps of Engineers, 2003 guidelines	6-Aug-15 GIM
	Seismic (Pseudo-static loading condition)	FOSmin = 1.0	US Army Corps of Engineers, 2003 guidelines	6-Aug-15 GIM
	Seismic (Post-earthquake loading condition; full Liquefaction of tailings)	FOSmin = 1.5	US Army Corps of Engineers, 2003 guidelines	6-Aug-15 GIM
Embankment Crest Width	Minimum 10 m at closure to provide suitable running width for haul trucks, pipelines, and for potential future raises.		28-Apr-15	GIM
3.0 WATER MANAGEMENT				
3.1 Water Management Objectives				
Freshwater Requirements & Availability	Approximately 163,000 m3 of make-up water will be required annually, sourced from dewatering of the underground mine workings.	Knights Piésold Ltd Letter Report Ref No. VA15-03200, October 7, 2015	9-Oct-15	GIM
External Water Sources	Water sourced from underground mine workings used for additional process make-up water.		6-Aug-15	GIM
Water Management Plan	Process water recycled for mill use from PWP.		28-Apr-15	GIM
	Water losses due to evaporation offset by mine site dewatering.		28-Apr-15	GIM
	Precipitation and run-off will be transferred to a water treatment plant and released.		6-Oct-15	GIM
	Excess mine inflows to be treated and released in underground LAD facility.		6-Aug-15	GIM
3.2 CTF and PWP Diversion Channels				
Function	Convey non-contact water from undisturbed mine areas during construction and operations.		6-May-15	JEF
Inflow Design Flood (IDF)	Probable Maximum Flood (850 mm over a 24 hour period)	Knights Piésold, FEMA	15-May-15	JL
Design Life	Construction Phase: 1 year, Operations Phase: 15 years.		6-May-15	JEF
Concept	Channels excavated into bedrock, lined with riprap where required.		6-May-15	JEF
Sediment Control	Diversion Ditches will flow into unlined energy dissipation and sediment control ponds. Ponds will be mucked out during dry periods.		6-Aug-15	GIM
3.3 Non-Contact Water Reservoir				
Function	Provide fresh water storage to offset mine site consumptive use. Water will be released into watershed throughout the dry season. No water from the NCWR will be used by the mine site.		6-May-15	JEF
Concept	Partially unlined impoundment to provide storage and freeboard for the freshwater to be released throughout dry periods to offset mine site consumptive water use. Upstream embankment face will have HDPE liner to prevent seepage through embankment fill.		14-May-15	GIM
Storage Capacity	Storage of 360,000 m3 freshwater and wave run-up.		6-May-15	JEF
Dam Hazard Classification	"LOW" as per FEMA, ICOLD and State of Montana Dam Safety Guidelines.	FEMA, ICOLD, State of MT	15-May-15	JL
Inflow Design Flood (IDF)	1 in 200 year 24 hour precipitation = 96 mm		9-Oct-15	GIM
Flood Management - Catchment Areas	Catchment Area = approximately 58.3 ha	Determined using currently facility layout	9-Oct-15	GIM
Inflow Design Flood (IDF) Volumes	0.06 Mm3 (based on catchment area and 96 mm IDF runoff depth)	Knights Piésold	16-May-15	JL
Design Freeboard	2 m freeboard for full containment of fresh water and wave run-up.		6-Aug-15	GIM
Embankment Slopes	2.5H:1V Side Slopes		6-Aug-15	GIM
Operational Criteria	Flood management: Spillway will pass through flood water in excess of required capacity into energy dissipation structure.		6-May-15	GIM
	Excess water monitored for flow volumes.		6-May-15	JEF
	Fresh water sourced from Sheep Creek, pumped into the impoundment during the spring freshet.		12-May-15	GIM
Diversion Channel	Channel size to pass the 1 in 100 year 24 hour storm event.		9-Oct-15	GIM
Closure Criteria	The HDPE geomembrane liner will be removed from the upstream face of the embankment, and the embankment will be excavated out to prevent ponding of water post-closure. The embankment fill will be hauled to the CTF to be used as capping material for the CTF closure. The remaining side slopes and embankment footprint area will be cover with topsoil and revegetated.		23-Feb-17	GIM
Seepage	Seepage will be allowed to pass into groundwater system untreated as all water within NCWR is non-contact fresh water.		6-May-15	JEF
Spillway Design	Spillway Designed to convey 1 in 200 year return period flood.		6-May-15	JEF
	Spillway will be excavated into bedrock, and lined with riprap along select locations as needed.		6-Aug-15	GIM
Embankment Crest Width	Minimum 10 m to provide suitable running width for haul trucks, pipelines, and for potential future raises.		6-May-15	JEF
3.4 Foundation Drain Collection Ponds				
Function	Collect groundwater flows and seepage from the foundation drain systems of the CTF and PWP		6-Aug-15	GIM
Concept	HDPE lined (100 mil) excavations to provide storage and freeboard to contain flows from foundation drain system, up to and including the 1 in 100 year 24 hour storm event.		6-Aug-15	GIM
Inflow Design Flood (IDF)	1 in 100 year 24 hour storm event		15-May-15	JL
Design Flood Volumes	2,000 m3 and 1,000 m3 for the CTF and PWP respectively (based on expected groundwater inflows to foundation drain system)		6-Aug-15	GIM
Design Freeboard	1 m freeboard for full containment of foundation drain outflows, storm event storage, and wave run-up.		6-Aug-15	GIM
Embankment Slopes	2.5H:1V Side Slopes		6-Aug-15	GIM
Operational Criteria	Flood management: SCP will be sized to contain the design flood event including anticipated seepage water.		6-Aug-15	GIM
	Water monitored and treated accordingly.		6-Aug-15	GIM
Closure Criteria	The SCP for the CTF will be maintained in order to collect seepage from the foundation drain system for water quality monitoring. The SCP for the PWP will have the liner removed, and the pond will be filled in with general fill, covered with topsoil and revegetated.		6-Aug-15	GIM
Seepage	Seepage will be controlled through the use of HDPE geomembrane to minimize seepage from pond.		6-Aug-15	GIM
	Collected seepage is monitored and pumped back in to respective facility.		6-Aug-15	GIM
4.0 TAILINGS DISTRIBUTION & RECLAIM PIPELINE SYSTEMS				
4.1 Tailings Stream				
Design Production Rate	Tailings Production Rate of 120.8 tpd (tonnes per hour)	Verbally Confirmed by TRI, 2 900 tpd (3,300 tpd minus 400 tpd to concentrate)	6-Aug-15	GIM
Physical Properties	Slurry Solids Content = 79% by weight (w/w)	TRI	6-May-15	JEF
	Specific Gravity of Solids = 3.77	SG Value provided by Jeff Austin (2015)	6-May-15	JEF
Plant Site Availability	Plant Site Availability of 92%.	TetraTech	6-May-15	JEF
4.2 Tailings Distribution Pipeline System				
Pipeline Specifications & Design Criteria	Single tailings stream from process mill		6-May-15	JEF
	Tailings Pipeline = 55% of tailings production rate.		6-May-15	JEF
	Single discharge offtake located at south end of CTF		6-Aug-15	GIM
	Tailings pipeline specification - 8" PN150 Steel Pipeline selected due to high pumping pressures.	MG Engineering	6-Oct-15	GIM
Emergency Discharge Plan	Tailings 'Emergency Discharge' plan is to backfill underground in case of tailings pipeline being offline.		6-Oct-15	GIM
Surge Capacity	Tailings pipeline pressure surge capacity = 20%		6-May-15	JEF
Tailings Pump	Tailings pump system to be designed by Tetra Tech		6-Oct-15	GIM
4.3 Mechanical Systems				
Pumping Systems	Two reclaim water systems for reclaim water for reuse in the mill process. Line 1: from PWP to Mill Site Line 2: CTF to PWP.		11-Aug-15	JEF
	Two seepage pumpback systems for return of seepage between HDPE geomembrane layers (leak detection and recovery): Line 1: PWP seepage collection sump recycle to PWP Line 2: CTF seepage collection sump to CTF		11-Aug-15	JEF
	Two pumpback systems for return of foundation drain flows: Line 1: PWP foundation drain collection pond to PWP Line 2: CTF foundation drain collection pond to CTF		11-Aug-15	JEF
	Source water pump system: Sheep Creek Two pumping systems for NCWR: Line 1: Sheep Creek source point to NCWR Line 2: NCWR to discharge point in downstream wetlands		27-May-15	GIM
General System Design Criteria	HDPE pipeline. Steel pipeline only if required to meet pipeline pressure requirements		26-May-15	RSS
	Double walled pipeline		26-May-15	RSS
	Pipeline diameter to be determined based on flow requirement		26-May-15	RSS
	HDPE Pipeline pressure selection range: DR 9 (max) to DR21 (min), rating selected to meet pump deadhead pressure capacity		26-May-15	RSS
	Pipeline design velocity: 1.5 - 2 m/s		26-May-15	RSS
	Pipeline alignment: selected to follow existing road alignments where possible		26-May-15	RSS
	No heat tracing or insulation of pipeline		26-May-15	RSS
Air release/vacuum valves located at all high points and at least every 600 metres		26-May-15	RSS	
Pump specification: either barge or wet well mounted depending on total LOM elevation change.		26-May-15	RSS	
Motors: 0 to 250 HP use 550V motor, >250 HP use 4.16KV motor.		18-Aug-15	MAP	
Reclaim Line 1 - PWP to Mill	Line 1 Reclaim system design flowrate = 615 m3/h 100% mill process water requirements and includes consideration of plant availability and 20% design factor. PWP water elevation = ~1792 m Maximum pipeline alignment elevation = 1800 m Plant Site discharge elevation = ~1790 m (top elevation of tank if discharged into Plant reclaim tank) Pump: Submersible pump in riser pipeline + stand-by unit installed on crest of PWP embankment on pad	This is based on the annual value from Tetra Tech (4,130,000 m3/yr) during full production and includes adjustment for 92% mill availability. Estimated based on 200,000 m3 throughout operating year	28-May-15	GIM
	Line 2 Reclaim system design flowrate = 75 m3/h	Design to dewater the 1:100 year storm event over a 10 day period = 20.3L/s (Knights Piésold Work File #25)	11-Aug-15	JEF
	CTF Basin floor elevation = 1765 m CTF Underdrain sump base elevation = 1761 m Maximum pipeline alignment elevation = 1802 m PWP discharge elevation (crest elevation of PWP) = 1800 m PWP closure crest elevation = 1800 m Pump: Submersible vertical turbine pump		11-Aug-15	JEF
Seepage Collection and Recycle Pump Line 1 - PWP pond	Line 1 Seepage pump system design flowrate = 29 m3/h	Knights Piésold Work File #26	11-Aug-15	JEF
	PWP Basin floor elevation = 1785 m PWP Seepage Collection Sump base elevation = 1780 m Maximum pipeline alignment elevation = 1800 m PWP discharge elevation (crest elevation of PWP) = 1800 m		11-Aug-15	JEF
			11-Aug-15	JEF
			11-Aug-15	JEF
			11-Aug-15	JEF
Seepage Collection and Recycle Pump Line 2 - CTF pond	Line 2 Seepage pump system design flowrate = 0.63 m3/h	Knights Piésold Work File #39	11-Aug-15	JEF
	CTF Basin floor elevation = 1765 m CTF Seepage Collection sump base elevation = 1761 m Maximum pipeline alignment elevation = 1799 m CTF discharge elevation (crest elevation of CTF) = 1799 m		11-Aug-15	JEF
			11-Aug-15	JEF
			11-Aug-15	JEF
Foundation Drain Collection & Recycle Pump Line 1 - PWP pond	Line 1 Seepage pump system design flowrate = 40 m3/h Design criteria = pump out of 1 in 100 year 24-hour storm event from contributing catchment over ten days. PWP discharge elevation (crest elevation of PWP) = 1800 m Maximum pipeline alignment elevation = 1800 m Foundation Drain Collection Pond minimum water level elevation = 1775 m Foundation Drain Collection Pond to be maintained as dry facility Pump: Centrifugal pump	Run-off and groundwater flows through foundation drains from 1:100 year storm event is 11.02 L/s (Knights Piésold Work File #28) Assumed value based on topography	11-Aug-15	JEF
			11-Aug-15	JEF
			11-Aug-15	JEF
			11-Aug-15	JEF
			18-Aug-15	MAP

TABLE A.1
TINTINA RESOURCES INC.
BLACK BUTTE COPPER PROJECT
FEASIBILITY DESIGN REPORT
SUMMARY OF DESIGN BASIS FOR THE CTF

Print: Apr/20/2017 13:46:09

ITEM	VALUE	SOURCE (Assumption if none noted)	DATE	Entered By:
Foundation Drain Collection & Recycle Pump Line 2 - CFT pond	Line 2 Seepage pump system design flowrate = 79 m ³ /h Design criteria = pump out of 1 in 100 year 24-hour storm event from contributing catchment over ten days.	Run-off and groundwater flows through foundation drains from 1:100 year storm event is 22.18 L/s (Knight Piésold Work File #6)	11-Aug-15	JEF
	CTF discharge elevation (crest elevation of CTF) = 1799 m		11-Aug-15	JEF
	Maximum pipeline alignment elevation = 1799 m		11-Aug-15	JEF
	Foundation Drain Collection Pond minimum water level elevation = 1750 m	Assumed value based on topography	11-Aug-15	JEF
	Foundation Drain Collection Pond to be maintained as dry facility		11-Aug-15	JEF
	Pump: Centrifugal pump		18-Aug-15	MAP
Non-Contact Water Reservoir Pump System Line 1 - Sheep Creek to NCWR	Source water pump design flowrate = 215 m ³ /h	Design criteria = To fill the NCWR with 300,000 m ³ of freshwater supply during in a 2-month freshet period assuming an additional 50,000 - 60,000 m ³ reports to the NCWR from natural runoff.	11-Aug-15	JEF
	Source water minimum water level elevation = 1710 m	Based on collection point specified by Allan Kirk, cross point between Sheep Creek and county road	11-Aug-15	JEF
	NCWR Embankment Crest Elevation = 1776.5 m	As measured in Civ3D model	11-Aug-15	JEF
	Maximum pipeline alignment elevation = 1776.5 m	Embankment crest is higher than intervening terrain.	11-Aug-15	JEF
	Pump: Vertical turbine pump		18-Aug-15	MAP
Non-Contact Water Reservoir Pump System Line 1 - NCWR to Discharge Spillway	Source water pump design flowrate = 42 m ³ /h	Assumes draining of facility prior to next season freshet sourcing (i.e. 10 months discharge from system, 2 months of filling during freshet)	11-Aug-15	JEF
	Intake water level elevation = 1765 m	Lowest point in reservoir, as measured in Civ3D model	11-Aug-15	JEF
	NCWR Embankment Crest Elevation = 1776.5 m	As measured in Civ3D model	11-Aug-15	JEF
	Maximum pipeline alignment elevation = 1776.5 m	Embankment crest is higher than intervening terrain.	11-Aug-15	JEF
	Pump: Pontoon-mounted centrifugal pump		18-Aug-15	MAP
Instrumentation and Monitoring	Pressure gauges on each pump unit discharge line Flowmeter on main discharge line from Pump Station Reclaim VFD control: feedback loop from level control in Plant-site reclaim tank		26-May-15	RSS
	5.0 Temporary Waste Rock Storage Pad			
Design Concept	Design of a temporary pad to store 500,000 t of pre-production and early operations PAG waste, including seepage collection measures.		6-Aug-15	GIM
Seepage control	HDPE geomembrane liner angled towards a run-off collection sump and culvert.		6-Aug-15	GIM
Surface water control	Run-off will be transferred via solid pipeline to a contact water pond located near the portal pad		23-Feb-17	GIM
6.0 MISCELLANEOUS				
Instrumentation and Monitoring	Vibrating wire piezometers to measure pore water pressure in the embankments and tailings mass.		6-May-15	JEF
	Inclinometers installed on embankments as required		6-May-15	JEF
	Flow monitoring equipment for foundation drain system outlet pipes.		6-May-15	JEF
	Pressure gauges and flowmeters on discharge lines of pump units.		6-May-15	JEF
Construction Materials	Bulking factor for overburden (Dry to moist SAND with some silt) is 12% before compaction, 5% after compaction		7-May-15	GIM
	Bulking factor for rock fill is 40-50% before compaction, 20% after compaction	Based on measured in situ rock density of 2.6 t/m ³ and an assumed compacted rock density of 2 to 2.2 t/m ³	6-Aug-15	GIM

\\KPL\VA-Pj\1010046\03\AI\Report2 - CTF WWMS Design for MOP Application\Rev 6\Appendices\Appendix A - Design Basis\4

0	20APR17	ISSUED WITH REPORT VA101-4603-2	JEF	GIM
REV	DATE	DESCRIPTION	PREP'D	REV'D

APPENDIX B
DESIGN DRAWINGS
(Pages B-1 to B-56)

SAV: M110104603\A-A-cad\DWG\CS\C0001\C0001 - 10/19/2015 1:04:08 PM - WLAHODA PRINTED: 10/19/2015 1:04:25 PM - C0001 - WLAHODA
 XREF FILES: IMAGE FILES

BLACK BUTTE COPPER PROJECT	
DRAWING NUMBERS	DESCRIPTION
C0002	INDEX SHEET
C0003	CONSTRUCTION MATERIAL SPECIFICATIONS
C1001	GENERAL ARRANGEMENT
C2001	CEMENTED TAILINGS FACILITY GRADING PLAN
C2002	CEMENTED TAILINGS FACILITY HDPE LINER SYSTEM LAYOUT PLAN
C2003	CEMENTED TAILINGS FACILITY SECTIONS AND DETAILS
C2004	CEMENTED TAILINGS FACILITY BASIN FOUNDATION DRAIN SYSTEM PLAN
C2006	CEMENTED TAILINGS FACILITY FOUNDATION DRAIN SECTIONS
C2008	CEMENTED TAILINGS FACILITY WASTE ROCK CO-DISPOSAL PLATFORM PLAN
C2010	CEMENTED TAILINGS FACILITY INSTRUMENTATION PLAN
C2011	CEMENTED TAILINGS FACILITY INSTRUMENTATION SECTIONS AND DETAILS
C3001	PROCESS WATER POND GRADING PLAN
C3002	PROCESS WATER POND HDPE LINER AND SEEPAGE COLLECTION LAYOUT PLAN
C3003	PROCESS WATER POND SECTIONS
C3004	PROCESS WATER POND BASIN FOUNDATION DRAIN SYSTEM PLAN
C3008	PROCESS WATER POND FOUNDATION DRAIN DETAILS
C3010	PROCESS WATER POND INSTRUMENTATION LAYOUT PLAN AND DETAIL
C4001	NON-CONTACT WATER RESERVOIR GRADING PLAN
C4002	NON-CONTACT WATER RESERVOIR HDPE LINER AND INSTRUMENTATION LAYOUT PLAN
C4003	NON-CONTACT WATER RESERVOIR SECTIONS
C4004	NON-CONTACT WATER RESERVOIR SPILLWAY CHANNEL PLAN AND PROFILE
C4005	NON-CONTACT WATER RESERVOIR SPILLWAY SECTIONS
C4006	NON-CONTACT WATER RESERVOIR DIVERSION CHANNEL PLAN
C4007	NON-CONTACT WATER RESERVOIR DIVERSION CHANNEL PROFILE AND SECTION
C5001	CEMENTED TAILINGS FACILITY DIVERSION CHANNEL PLAN AND PROFILE
C5002	PROCESS WATER POND DIVERSION CHANNEL PLAN AND PROFILE
C5003	DIVERSION CHANNEL TYPICAL SECTIONS
C5004	DIVERSION CHANNEL ENERGY DISSIPATOR PLAN AND SECTION
C5005	EROSION CONTROL BMP TYPICAL SECTIONS AND DETAILS SHEET 1 OF 2
C5006	EROSION CONTROL BMP TYPICAL SECTIONS AND DETAILS SHEET 2 OF 2
C6100	TAILINGS DELIVERY SYSTEM PLAN
C6200	CEMENTED TAILINGS FACILITY WATER MANAGEMENT SYSTEMS PIPING AND INSTRUMENTATION DIAGRAM
C6210	CEMENTED TAILINGS FACILITY SEEPAGE COLLECTION AND RECYCLE SYSTEM AND CEMENTED TAILINGS FACILITY RECLAIM SYSTEM PLAN AND PROFILE
C6220	CEMENTED TAILINGS FACILITY WATER MANAGEMENT SYSTEMS TYPICAL SECTION - 1 OF 2
C6230	CEMENTED TAILINGS FACILITY WATER MANAGEMENT SYSTEMS TYPICAL SECTIONS - 2 OF 2
C6250	RECLAIM WATER DELIVERY SYSTEM PROCESS WATER POND TO MILL SITE PIPING AND INSTRUMENTATION DIAGRAM
C6260	RECLAIM WATER DELIVERY SYSTEM PROCESS WATER POND TO MILL SITE PLAN AND PROFILE
C6270	RECLAIM WATER DELIVERY SYSTEM PROCESS WATER POND TO MILL SITE TYPICAL SECTIONS
C6300	FOUNDATION DRAIN PUMPBACK SYSTEM PIPING AND INSTRUMENTATION DIAGRAM
C6310	FOUNDATION DRAIN PUMPBACK SYSTEM CEMENTED TAILINGS FACILITY PLAN AND PROFILE
C6320	FOUNDATION DRAIN PUMPBACK SYSTEM PROCESS WATER POND PLAN AND PROFILE
C6330	RECLAIM WATER DELIVERY SYSTEM SEEPAGE COLLECTION AND PUMPBACK SYSTEM CEMENTED TAILINGS FACILITY AND PROCESS WATER POND TYPICAL SECTIONS
C6400	NON-CONTACT WATER RESERVOIR SUPPLY AND DISCHARGE SYSTEM PIPING AND INSTRUMENTATION DIAGRAM
C6410	NON-CONTACT WATER RESERVOIR SUPPLY SYSTEM PLAN AND PROFILE
C6420	NON-CONTACT WATER RESERVOIR SUPPLY SYSTEM SECTIONS AND DETAILS

BLACK BUTTE COPPER PROJECT	
DRAWING NUMBERS	DESCRIPTION
C6430	NON-CONTACT WATER RESERVOIR DISCHARGE SYSTEM PLAN AND PROFILE
C6440	NON-CONTACT WATER RESERVOIR DISCHARGE SYSTEM TYPICAL SECTIONS
C6500	PROCESS WATER POND SEEPAGE COLLECTION AND RECYCLE SYSTEM PIPING & INSTRUMENTATION DIAGRAM
C6510	PROCESS WATER POND SEEPAGE COLLECTION AND RECYCLE SYSTEM PLAN AND PROFILE
C6520	PROCESS WATER POND SEEPAGE COLLECTION AND RECYCLE SYSTEM TYPICAL SECTIONS AND DETAIL
C7001	TEMPORARY WASTE ROCK STORAGE PAD GRADING PLAN
C7002	TEMPORARY WASTE ROCK STORAGE PAD HDPE LINER AND SEEPAGE COLLECTION SYSTEM LAYOUT PLAN
C7003	TEMPORARY WASTE ROCK STORAGE PAD SECTIONS AND DETAILS
C8001	CEMENTED TAILINGS FACILITY, PROCESS WATER POND, NON-CONTACT WATER RESERVOIR AND ROM STOCKPILE POST CLOSURE TOPOGRAPHIC MAP
C8002	CEMENTED TAILINGS FACILITY RECLAMATION SECTION AND DETAIL

FOR INFORMATION ONLY

-- DISCLAIMER -- <small>THIS DRAWING WAS PREPARED BY KNIGHT PIESOLD LTD. FOR THE ACCOUNT OF THE CLIENT LISTED ON THIS DRAWING. THE MATERIAL ON IT REFLECTS KNIGHT PIESOLD'S BEST JUDGMENT IN THE LIGHT OF THE INFORMATION AVAILABLE TO IT AT THE TIME OF PREPARATION. ANY USE WHICH A THIRD PARTY MAKES OF THIS DRAWING, OR ANY RELIANCE ON OR DECISIONS TO BE MADE BASED ON IT, ARE THE RESPONSIBILITY OF SUCH THIRD PARTIES. KNIGHT PIESOLD ACCEPTS NO RESPONSIBILITY FOR DAMAGES, IF ANY, SUFFERED BY THE THIRD PARTY AS A RESULT OF DECISIONS MADE OR ACTIONS BASED ON THIS DRAWING. COPIES RESULTING FROM ELECTRONIC TRANSFER OR REPRODUCTION OF THIS DRAWING ARE UNCONTROLLED AND MAY NOT BE THE MOST RECENT REVISION OF THIS DRAWING.</small>	
 Knigh<i>t</i> P<i>iesold</i> CONSULTING	
TINTINA RESOURCES INC.	
BLACK BUTTE COPPER PROJECT	
DRAWING LIST	
PIA NO.	REVISION
VA101-460/3	0

DRG NO.	DESCRIPTION	REV	DATE	DESCRIPTION	DESIGNED	DRAWN	REVIEWED	APPROVED	REV	DATE	DESCRIPTION	DESIGNED	DRAWN	REVIEWED	APPROVED
	REFERENCE DRAWINGS			REVISIONS							REVISIONS				
										0	15OCT15	ISSUED FOR MOP APPLICATION	GIM	PP	

SECTIONAL VIEW AND DETAIL IDENTIFICATION

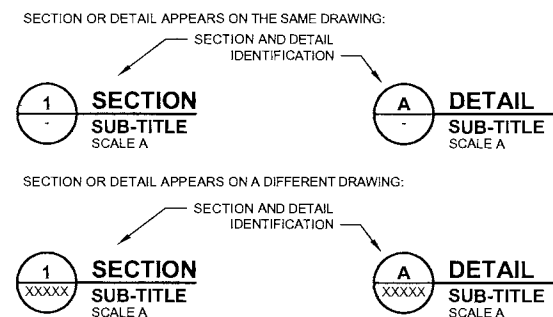

SECTION LOCATION ARROWS

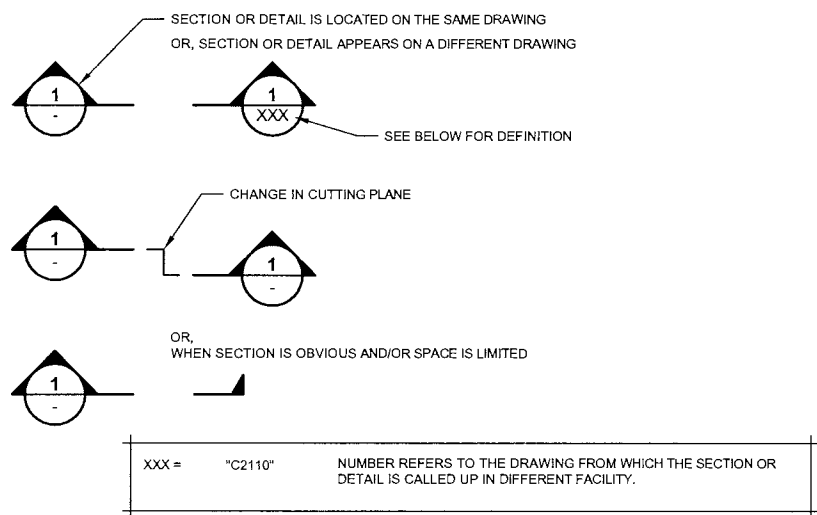

DETAIL REFERENCE

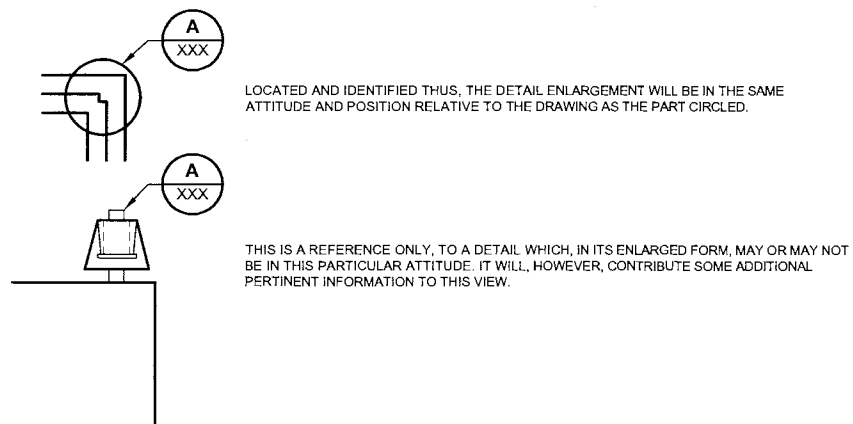

LEGEND

- FOUNDATION TREATMENT
- OVERBURDEN
- MINIMUM EXCAVATION LINE
- APPROX. (OR ASSUMED) ROCK SURFACE
- GEOTEXTILE
- HDPE GEOMEMBRANE
- GEONET
- FILL SLOPE SYMBOL
- CUT SLOPE SYMBOL
- SLOPE - CONCRETE FACE
- 1ST STAGE CONCRETE
- 2ND STAGE CONCRETE
- OPENING OR BLOCKOUT
- FLOW DIRECTION
- W.L. EL. XXX WATER LEVEL
- INFERRED GROUNDWATER LEVEL
- #H:1V SLOPE (ARROW POINTS DOWN SLOPE)
- PIPE END
- TUBULAR SECTION ON END
- CREST EL. 273.5 OR INDICATE AN AREA ON PLAN VIEW
- MATCH LINE
- WATER

FOR INFORMATION ONLY

<p>- DISCLAIMER -</p> <p>THIS DRAWING WAS PREPARED BY KNIGHT PIESOLD LTD. FOR THE ACCOUNT OF THE CLIENT LISTED ON THIS DRAWING. THE MATERIAL ON IT REFLECTS KNIGHT PIESOLD'S BEST JUDGEMENT IN THE LIGHT OF THE INFORMATION AVAILABLE TO IT AT THE TIME OF PREPARATION. ANY USE WHICH A THIRD PARTY MAKES OF THIS DRAWING OR ANY RELIANCE ON OR DECISIONS TO BE MADE BASED ON IT ARE THE RESPONSIBILITY OF SUCH THIRD PARTIES. KNIGHT PIESOLD ACCEPTS NO RESPONSIBILITY FOR DAMAGES, IF ANY, SUFFERED BY THE THIRD PARTY AS A RESULT OF DECISIONS MADE OR ACTIONS BASED ON THIS DRAWING. COPIES RESULTING FROM ELECTRONIC TRANSFER OR REPRODUCTION OF THIS DRAWING ARE UNCONTROLLED AND MAY NOT BE THE MOST RECENT REVISION OF THIS DRAWING.</p>		
<p><i>Knicht Piesold</i> CONSULTING</p>		
<p>TINTINA RESOURCES INC.</p>		
<p>BLACK BUTTE COPPER PROJECT</p>		
<p>INDEX SHEET</p>		
P/A NO.	DRAWING NO.	REVISION
VA101-460/3	C0002	0

SAVEP: M:\101\101460\DRG\VA101-460\DWG\C0002\C0002_1016162015 9:58:07 AM . PPRTRKVIC PRINTED: 10/19/2015 9:54:01 AM . C0002 . WJAHODA XREF FILE(S) : IMAGE FILE(S)

DRG. NO.	DESCRIPTION	REV.	DATE	DESIGNED	DRAWN	REVIEWED	APPROVED	0	15OCT'15	ISSUED FOR MOP APPLICATION	GIM	NSD	U.	U.	
REFERENCE DRAWINGS				REVISIONS				REVISIONS							

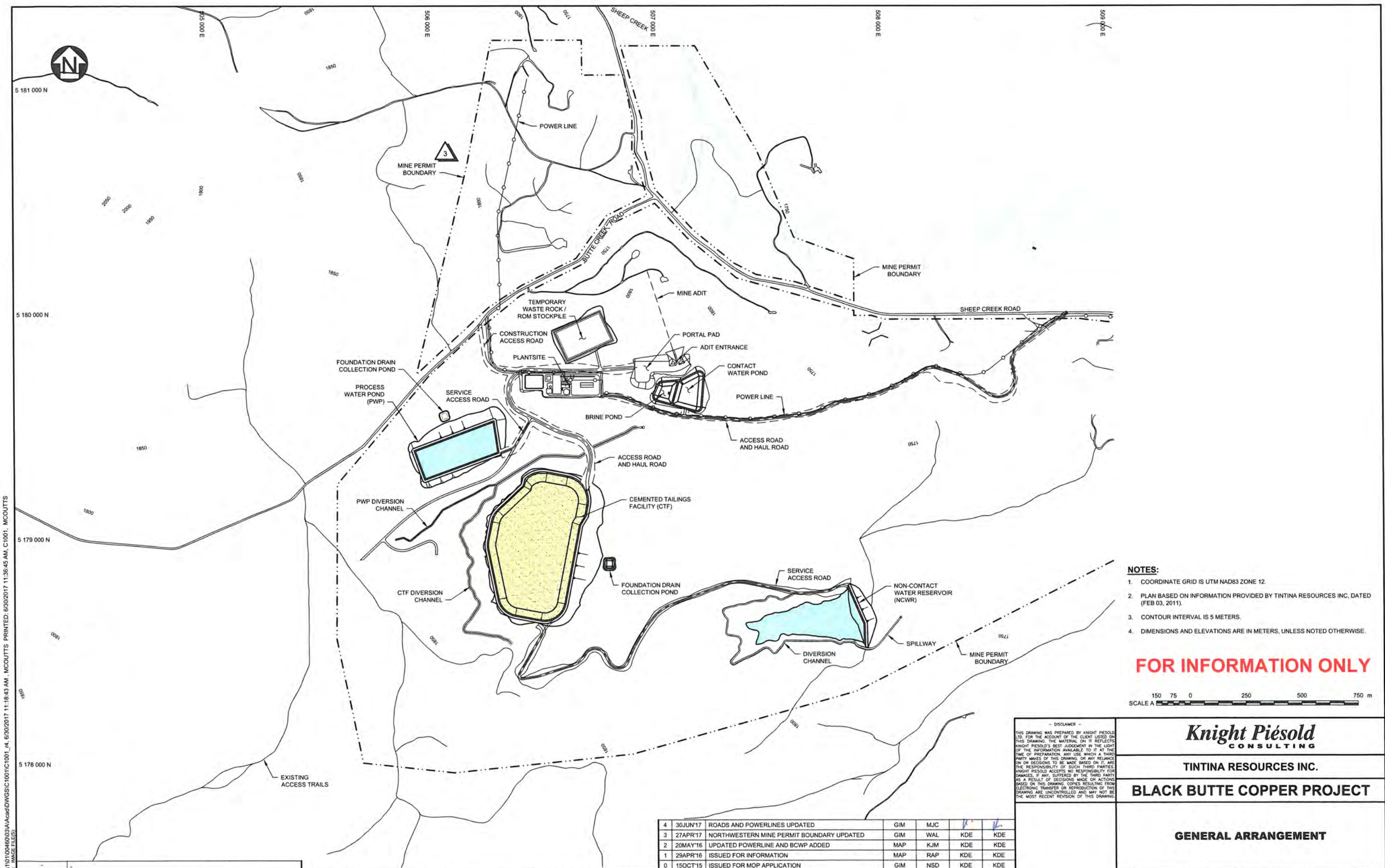

- NOTES:**
1. COORDINATE GRID IS UTM NAD83 ZONE 12.
 2. PLAN BASED ON INFORMATION PROVIDED BY TINTINA RESOURCES INC, DATED (FEB 03, 2011).
 3. CONTOUR INTERVAL IS 5 METERS.
 4. DIMENSIONS AND ELEVATIONS ARE IN METERS, UNLESS NOTED OTHERWISE.

FOR INFORMATION ONLY



DISCLAIMER
 THIS DRAWING WAS PREPARED BY KNIGHT PIESOLD LTD. FOR THE ACCOUNT OF THE CLIENT LISTED ON THIS DRAWING. THE MATERIAL ON IT REFLECTS KNIGHT PIESOLD'S BEST JUDGEMENT IN THE LIGHT OF THE INFORMATION AVAILABLE TO IT AT THE TIME OF PREPARATION. ANY USE WHICH A THIRD PARTY MAKES OF THIS DRAWING OR ANY RELIANCE ON OR DECISIONS TO BE MADE BASED ON IT, ARE THE RESPONSIBILITY OF SUCH THIRD PARTIES. KNIGHT PIESOLD ACCEPTS NO RESPONSIBILITY FOR DAMAGES, IF ANY, SUFFERED BY THE THIRD PARTY AS A RESULT OF DECISIONS MADE OR ACTIONS BASED ON THIS DRAWING. COPIES RESULTING FROM ELECTRONIC TRANSFER OR REPRODUCTION OF THIS DRAWING ARE UNCONTROLLED AND MAY NOT BE THE MOST RECENT REVISION OF THIS DRAWING.

Knight Piesold
 CONSULTING

TINTINA RESOURCES INC.

BLACK BUTTE COPPER PROJECT

GENERAL ARRANGEMENT

REV	DATE	DESCRIPTION	DESIGNED	DRAWN	REVIEWED	APPROVED
4	30JUN'17	ROADS AND POWERLINES UPDATED	GIM	MJC	K	L
3	27APR'17	NORTHWESTERN MINE PERMIT BOUNDARY UPDATED	GIM	WAL	KDE	KDE
2	20MAY'16	UPDATED POWERLINE AND BCWP ADDED	MAP	KJM	KDE	KDE
1	29APR'16	ISSUED FOR INFORMATION	MAP	RAP	KDE	KDE
0	15OCT'15	ISSUED FOR MOP APPLICATION	GIM	NSD	KDE	KDE

DRG. NO.	DESCRIPTION	REV	DATE
	REFERENCE DRAWINGS		

DESIGNED	DRAWN	REVIEWED	APPROVED

REV	DATE	DESCRIPTION	DESIGNED	DRAWN	REVIEWED	APPROVED

PIA NO. **VA101-460/3**

DRAWING NO. **C1001**

REVISION **4**

SAVED: M:\11010046003\A\cad\DWG\SS\1001\C1001_14_6\30\2017 11:18:43 AM . MCOULTTS PRINTED: 6/30/2017 11:36:45 AM, C1001, MCOULTTS
 (REF FILES) IMAGE FILE(S)

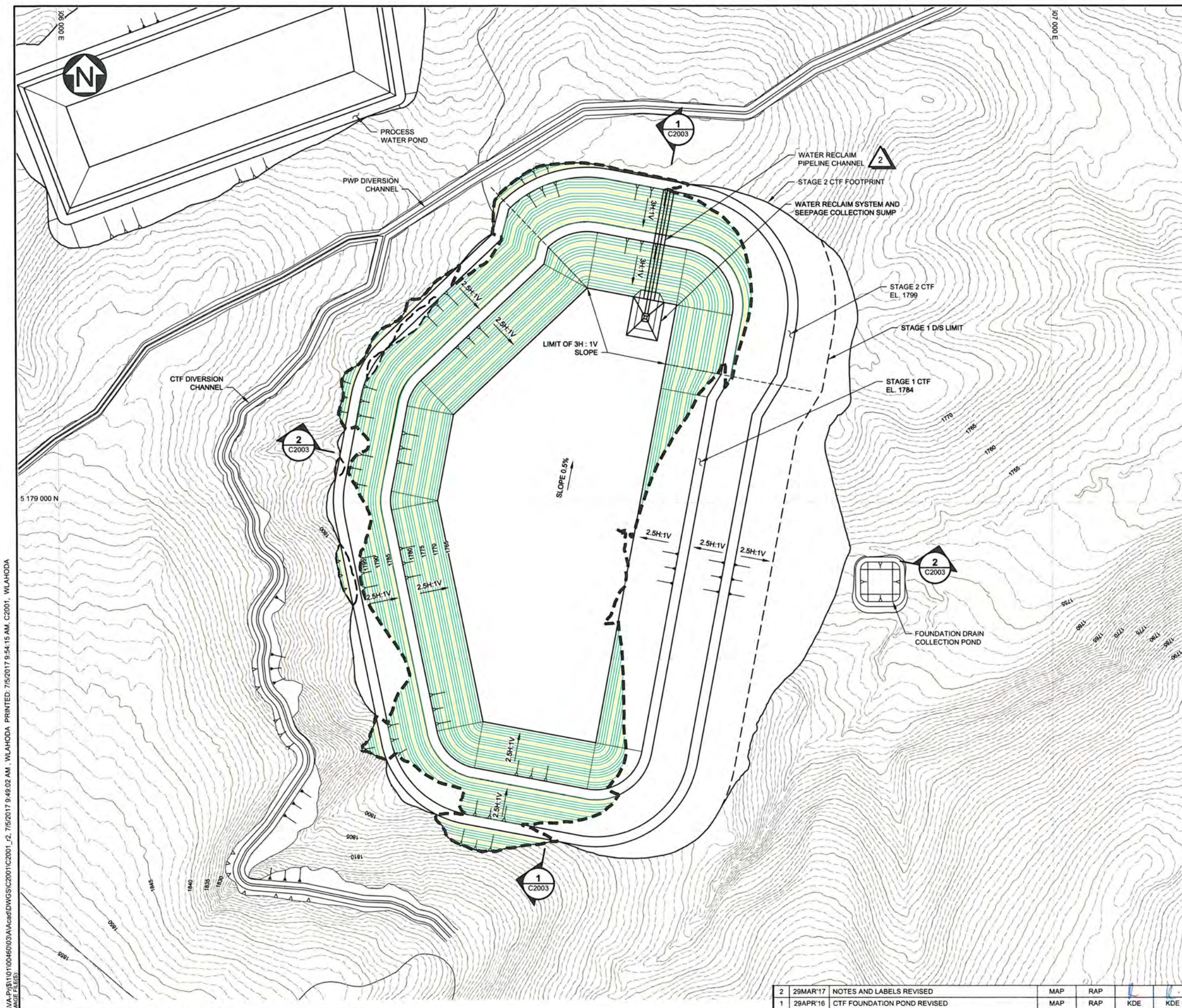

- LEGEND:**
- EXCAVATION CONTOURS
 - ORIGINAL STRIPPED GROUND CONTOURS TO BE REGRADED
 - CUT/FILL TRANSITION

- NOTES:**
1. COORDINATE GRID IS UTM NAD83 ZONE 12.
 2. PLAN BASED ON INFORMATION PROVIDED BY TINTINA RESOURCES, DATED (FEB 03, 2011).
 3. CONTOUR INTERVAL IS 1 METER.
 4. DIMENSIONS AND ELEVATIONS ARE IN METERS, UNLESS NOTED OTHERWISE.
 5. FILL CONTOURS NOT SHOWN FOR CLARITY.

FOR INFORMATION ONLY

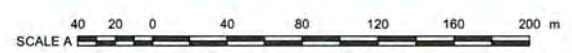

- DISCLAIMER -
THIS DRAWING WAS PREPARED BY KNIGHT PIESOLD LTD. FOR THE ACCOUNT OF THE CLIENT LISTED ON THIS DRAWING. THE MATERIAL ON IT REFLECTS KNIGHT PIESOLD'S BEST JUDGEMENT IN THE LIGHT OF THE INFORMATION AVAILABLE TO IT AT THE TIME OF PREPARATION. ANY USE WHICH A THIRD PARTY MAKES OF THIS DRAWING OR ANY RELIANCE ON OR DECISIONS TO BE MADE BASED ON IT, ARE THE RESPONSIBILITY OF SUCH THIRD PARTIES. KNIGHT PIESOLD ACCEPTS NO RESPONSIBILITY FOR DAMAGES, IF ANY, SUFFERED BY THE THIRD PARTY AS A RESULT OF DECISIONS MADE OR ACTIONS BASED ON THIS DRAWING. COPIES RESULTING FROM ELECTRONIC TRANSFER OR REPRODUCTION OF THIS DRAWING ARE UNCONTROLLED AND MAY NOT BE THE MOST RECENT REVISION OF THIS DRAWING.

Knight Piesold
CONSULTING

TINTINA RESOURCES INC.

BLACK BUTTE COPPER PROJECT

CEMENTED TAILINGS FACILITY
GRADING PLAN

REV	DATE	DESCRIPTION	DESIGNED	DRAWN	REVIEWED	APPROVED
2	29MAR'17	NOTES AND LABELS REVISED	MAP	RAP		
1	29APR'16	CTF FOUNDATION POND REVISED	MAP	RAP	KDE	KDE
0	15OCT'15	ISSUED FOR MOP APPLICATION	GIM	NSD	KDE	KDE

REV	DATE	DESCRIPTION	DESIGNED	DRAWN	REVIEWED	APPROVED

REV	DATE	DESCRIPTION	DESIGNED	DRAWN	REVIEWED	APPROVED

P/A NO.	DRAWING NO.	REVISION
VA101-460/3	C2001	2

SAVED: \\KPL\VA-P\811010046003\VA101-460\DWG\C2001\C2001_2_7152017 9:49:02 AM - WLAHODA PRINTED: 7/15/2017 9:54:15 AM - C2001 - WLAHODA XREF FILES: IMAGE FILES:

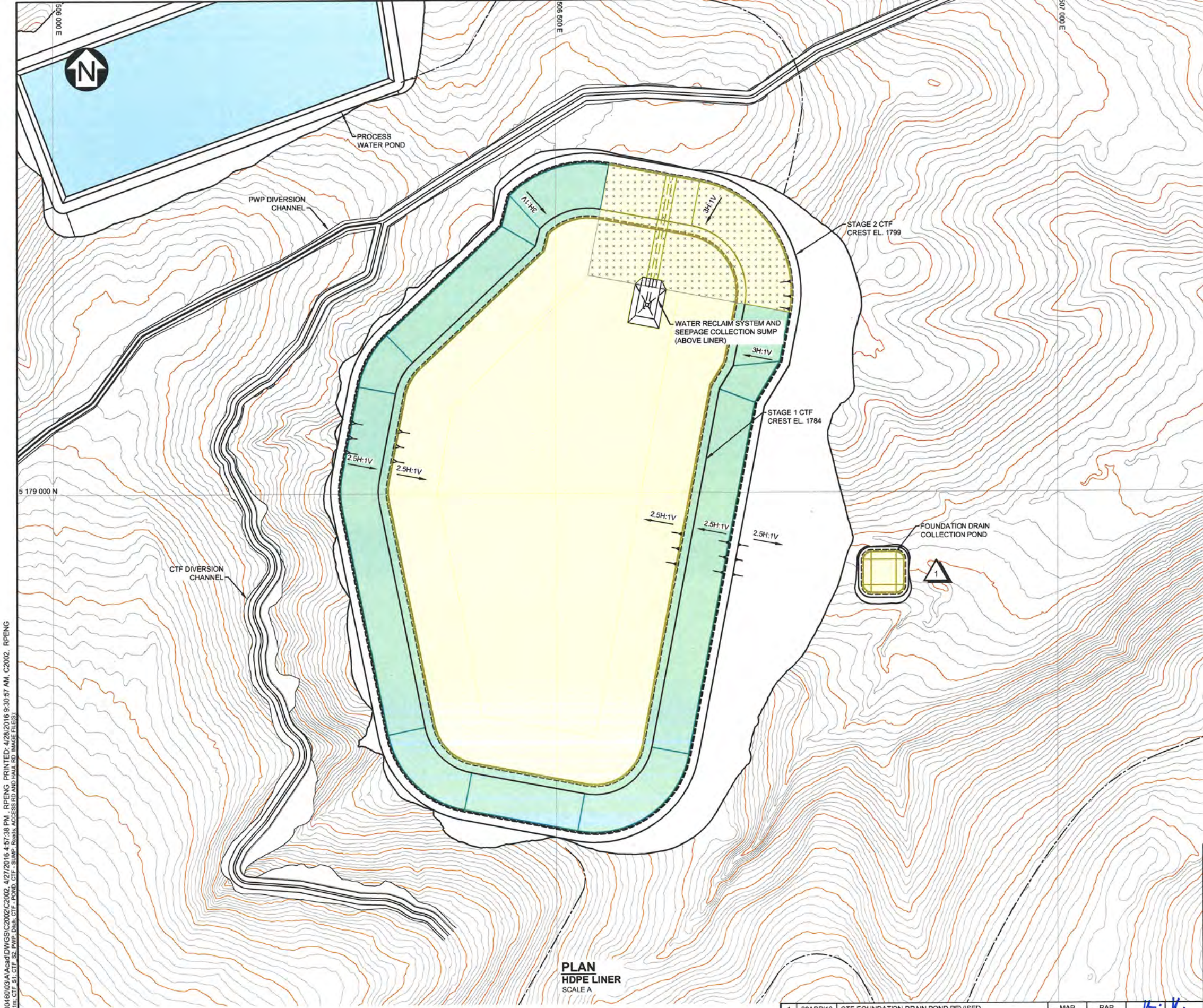

LEGEND:

- STAGE 1 LINER SYSTEM
- STAGE 2 LINER SYSTEM
- TEXTURED 100MIL HDPE GEOMEMBRANE
- LINER SYSTEM ANCHOR TRENCH

NOTES:

1. COORDINATE GRID IS UTM NAD83 ZONE 12.
2. PLAN BASED ON INFORMATION PROVIDED BY TINTINA RESOURCES INC., DATED (FEB 03, 2011).
3. CONTOUR INTERVAL IS 1 METER.
4. DIMENSIONS AND ELEVATIONS ARE IN METERS, UNLESS NOTED OTHERWISE.
5. HDPE LINER CONFIGURATION SHOWN ON DRG. C2005.
6. TEXTURED HDPE LINER REQUIRED TO FACILITATE FILL PLACEMENT FOR HAUL RAMP.

FOR INFORMATION ONLY

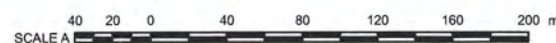

**PLAN
HDPE LINER
SCALE A**

- DISCLAIMER -
THIS DRAWING WAS PREPARED BY KNIGHT PIESOLD LTD. FOR THE ACCOUNT OF THE CLIENT LISTED ON THIS DRAWING. THE MATERIAL ON IT REFLECTS KNIGHT PIESOLD'S BEST JUDGMENT IN THE LIGHT OF THE INFORMATION AVAILABLE TO IT AT THE TIME OF PREPARATION. ANY USE WHICH A THIRD PARTY MAKES OF THIS DRAWING OR ANY RELIANCE ON OR DECISIONS TO BE MADE BASED ON IT, ARE THE RESPONSIBILITY OF SUCH THIRD PARTIES. KNIGHT PIESOLD ACCEPTS NO RESPONSIBILITY FOR DAMAGES, IF ANY, SUFFERED BY THE THIRD PARTY AS A RESULT OF DECISIONS MADE OR ACTIONS BASED ON THIS DRAWING. COPIES RESULTING FROM ELECTRONIC TRANSFER OR REPRODUCTION OF THIS DRAWING ARE UNCONTROLLED AND MAY NOT BE THE MOST RECENT REVISION OF THIS DRAWING.

Knights Piesold
CONSULTING

TINTINA RESOURCES INC.

BLACK BUTTE COPPER PROJECT

CEMENTED TAILINGS FACILITY
HDPE LINER SYSTEM LAYOUT
PLAN

REV	DATE	DESCRIPTION	DESIGNED	DRAWN	REVIEWED	APPROVED
1	29APR'16	CTF FOUNDATION DRAIN POND REVISED	MAP	RAP	KDE	KDE
0	15OCT'15	ISSUED FOR MOP APPLICATION	GIM	PP	KDE	KDE

DRG. NO.	DESCRIPTION	REV	DATE	DESCRIPTION	DESIGNED	DRAWN	REVIEWED	APPROVED
C2001	CEMENTED TAILINGS FACILITY GRADING PLAN							

PIA NO. VA101-460/3	DRAWING NO. C2002	REVISION 1
-------------------------------	-----------------------------	----------------------

SAVED: M:\101\00460\03\Acad\DWG\C2002\C2002_4\27\2016 4:57:38 PM - RPENG PRINTED: 4/28/2016 9:30:57 AM, C2002, RPENG XREF FILES: Top, Lin, CTF, S1, CTF, S2, PWP, Ditch, CTF, Pond, CTF, Sump, Roads, ACCESS RD AND HAUL RD, IMAGE FILES

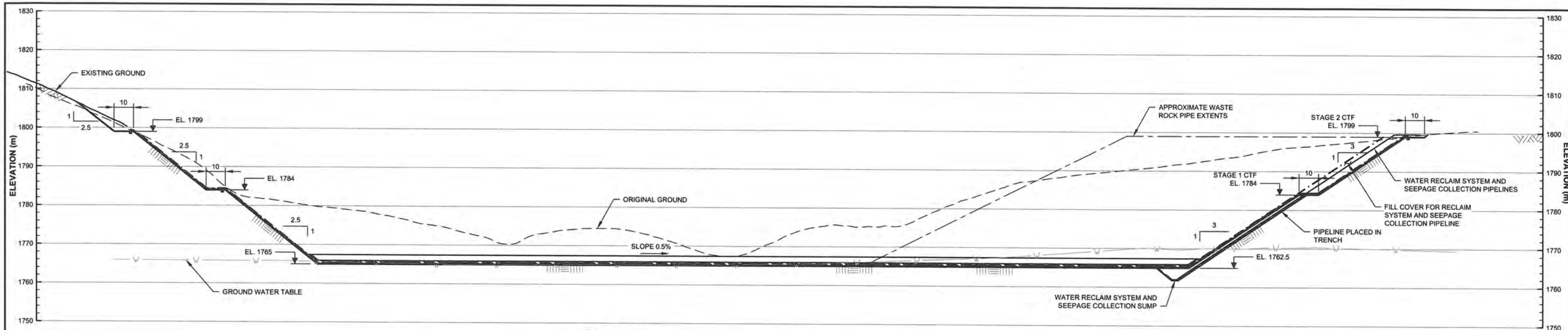

1 SECTION
C2001
HORIZONTAL: SCALE A
VERTICAL: SCALE B

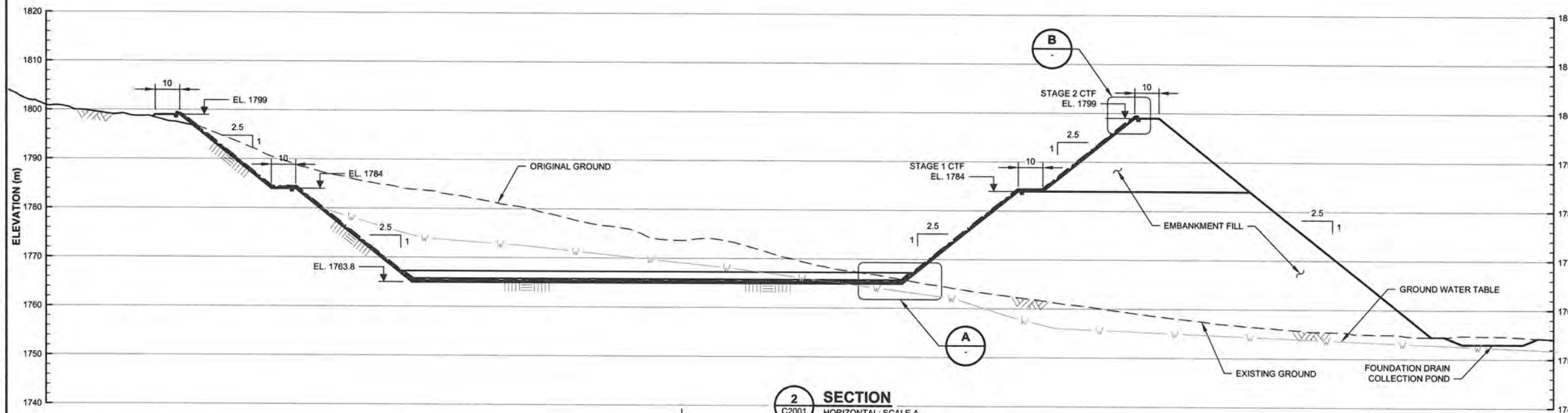

2 SECTION
C2001
HORIZONTAL: SCALE A
VERTICAL: SCALE B

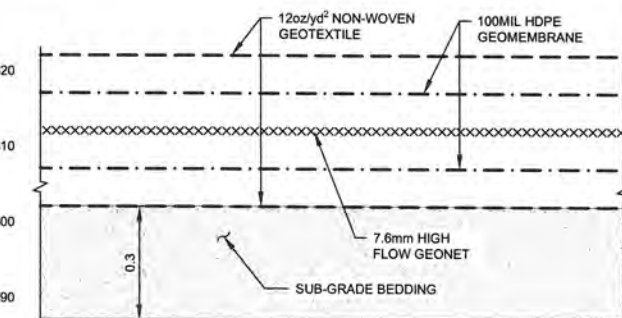

C DETAIL
LINER SYSTEM DETAILS
SCALE D

FOR INFORMATION ONLY

- NOTES:**
- DIMENSIONS AND ELEVATIONS ARE IN METERS, UNLESS NOTED OTHERWISE.
 - BASIN DRAIN THICKNESS BASED ON AVAILABLE WASTE ROCK VOLUME
 - THE WASTE ROCK LAYER IN DETAIL "A" HAS NO MATERIAL OR COMPACTION SPECIFICATIONS.

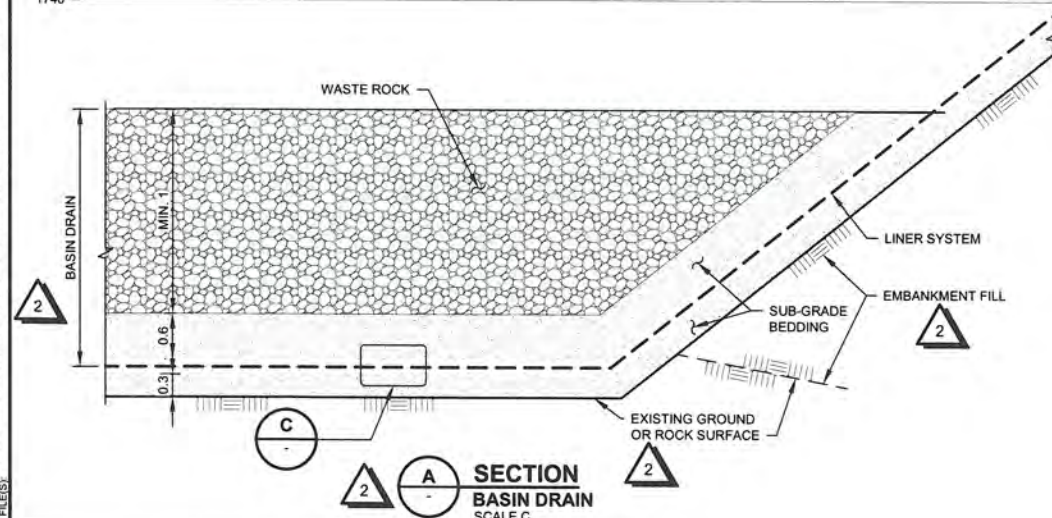
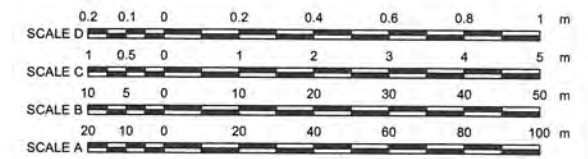

A SECTION
BASIN DRAIN
SCALE C

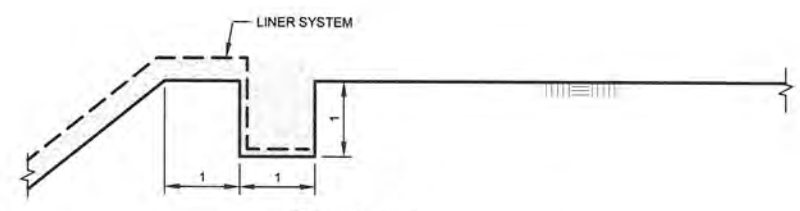

B DETAIL
ANCHOR TRENCH DETAIL
SCALE C

C2005	CEMENTED TAILINGS FACILITY DETAILS					
C2001	CEMENTED TAILINGS FACILITY GRADING PLAN					
DRG. NO.	DESCRIPTION					
REV	DATE	DESCRIPTION	DESIGNED	DRAWN	REVIEWED	APPROVED
REFERENCE DRAWINGS		REVISIONS				

2	20APR17	NOTES AND LABELS REVISED	GIM	RAF		
1	29APR16	GROUND WATER TABLE ADDED	GIM	RAP	KDE	KDE
0	15OCT15	ISSUED FOR MOP APPLICATION	GIM	NSD	KJB	KJB
REV	DATE	DESCRIPTION	DESIGNED	DRAWN	REVIEWED	APPROVED
REVISIONS			REVISIONS			

DISCLAIMER
THIS DRAWING WAS PREPARED BY KNIGHT PIESOLD LTD. FOR THE ACCOUNT OF THE CLIENT LISTED ON THIS DRAWING. THE MATERIAL ON IT REFLECTS KNIGHT PIESOLD'S BEST JUDGEMENT IN THE LIGHT OF THE INFORMATION AVAILABLE TO IT AT THE TIME OF PREPARATION. ANY USE WHICH A THIRD PARTY MAKES OF THIS DRAWING, OR ANY RELIANCE ON OR DECISIONS TO BE MADE BASED ON IT, ARE THE RESPONSIBILITY OF SUCH THIRD PARTIES. KNIGHT PIESOLD ACCEPTS NO RESPONSIBILITY FOR DAMAGES, IF ANY, SUFFERED BY THE THIRD PARTY AS A RESULT OF DECISIONS MADE OR ACTIONS BASED ON THIS DRAWING. COPIES RESULTING FROM ELECTRONIC TRANSFER OR REPRODUCTION OF THIS DRAWING ARE UNCONTROLLED AND MAY NOT BE THE MOST RECENT REVISION OF THIS DRAWING.

Knightsold CONSULTING

TINTINA RESOURCES INC.

BLACK BUTTE COPPER PROJECT

CEMENTED TAILINGS FACILITY SECTIONS AND DETAILS

PIA NO.	DRAWING NO.	REVISION
VA101-460/3	C2003	2

SAVED: M:\10100460\3\VA101-460\3\C2003\C2003_12_4\20170317 3:56:43 PM - RFAHAM PRINTED: 4/20/2017 3:57:40 PM, C2003, RFAHAM XREF FILES, IMAGE FILES

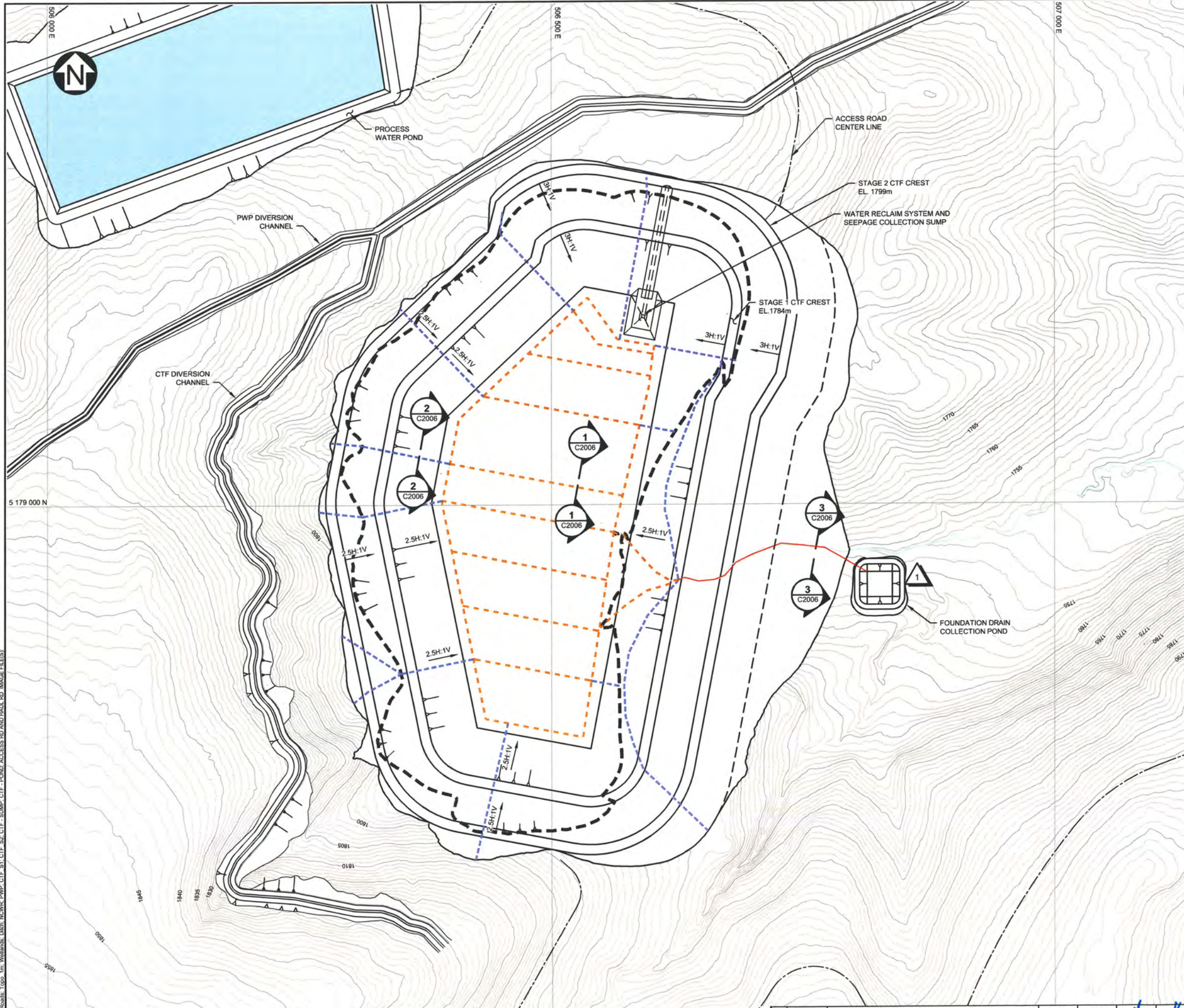

- LEGEND:**
- 250mm (10") N12 WT PE OUTLET PIPE
 - - - 200mm (8") N12 ST PE DRAIN PIPE (BASIN FLOOR)
 - - - 100mm (4") N12 ST PE DRAIN PIPE (CUT SLOPES)
 - - - CUT/FILL TRANSITION

- NOTES:**
1. COORDINATE GRID IS UTM NAD83 ZONE 12.
 2. CONTOUR INTERVAL IS 1 METER.
 3. DIMENSIONS AND ELEVATIONS ARE IN METERS, UNLESS NOTED OTHERWISE.
 4. DRAIN TRENCHES WILL BE SLOPED TOWARDS OUTLET PIPE CONNECTION AT A MINIMUM GRADE OF 0.5%.
 5. LAST 10m OF OUTLET PIPE WILL BE SOLID PIPE BACKFILLED WITH IMPERMEABLE MATERIAL.
 6. OUTLET PIPE WILL EMPTY INTO A WEIR TO MEASURE PIPE FLOW.

FOR INFORMATION ONLY



- DISCLAIMER -
THIS DRAWING WAS PREPARED BY KNIGHT PIESOLD LTD. FOR THE ACCOUNT OF THE CLIENT LISTED ON THIS DRAWING. THE MATERIAL ON IT REFLECTS KNIGHT PIESOLD'S BEST JUDGMENT IN THE LIGHT OF THE INFORMATION AVAILABLE TO IT AT THE TIME OF PREPARATION. ANY USE WHICH A THIRD PARTY MAKES OF THIS DRAWING, OR ANY RELIANCE ON OR DECISIONS TO BE MADE BASED ON IT, ARE THE RESPONSIBILITY OF SUCH THIRD PARTIES. KNIGHT PIESOLD ACCEPTS NO RESPONSIBILITY FOR DAMAGES, IF ANY, SUFFERED BY THE THIRD PARTY AS A RESULT OF DECISIONS MADE OR ACTIONS BASED ON THIS DRAWING. COPIES RESULTING FROM ELECTRONIC TRANSFER OR REPRODUCTION OF THIS DRAWING ARE UNCONTROLLED AND MAY NOT BE THE MOST RECENT REVISION OF THIS DRAWING.

Knight Piesold
CONSULTING

TINTINA RESOURCES INC.

BLACK BUTTE COPPER PROJECT

**CEMENTED TAILINGS FACILITY
BASIN FOUNDATION DRAIN SYSTEM
PLAN**

PIA NO.	DRAWING NO.	REVISION
VA101-460/3	C2004	1

C2006 CEMENTED TAILINGS FACILITY FOUNDATION DRAIN SYSTEM SECTIONS
 DRG. NO. DESCRIPTION REV. DATE DESCRIPTION DESIGNED DRAWN REVIEWED APPROVED
 REFERENCE DRAWINGS REVISIONS REVISIONS
 1 29APR16 CTF SEEPAGE POND REVISED MAP RAP K. K.
 0 15OCT15 ISSUED FOR MOP APPLICATION GIM NSD KDE KDE
 SAVER: M:\11010046003\AA\cadd\DWGS\C2004\C2004_4\272016 1:55:43 PM, RPENG PRINTED: 4/27/2016 2:18:40 PM, C2004, RPENG
 XREF FILE(S): Hydro, Roads, Topo, 1m, Wetlands, Data, MCMR, PWP, CTF, ST, CTF, SE, CTF, SUMP, CTF, POND, ACCESS ROAD, HALL, RD, IMAGE FILE(S)

SAV: M:\1101004003\A\Acad\DWGS\C2006\C2006_1_1_4202017 3:44:43 PM - RFAHAM PRINTED: 4/20/2017 3:45:07 PM, C2006, RFAHAM XREF FILES - IMAGE FILES

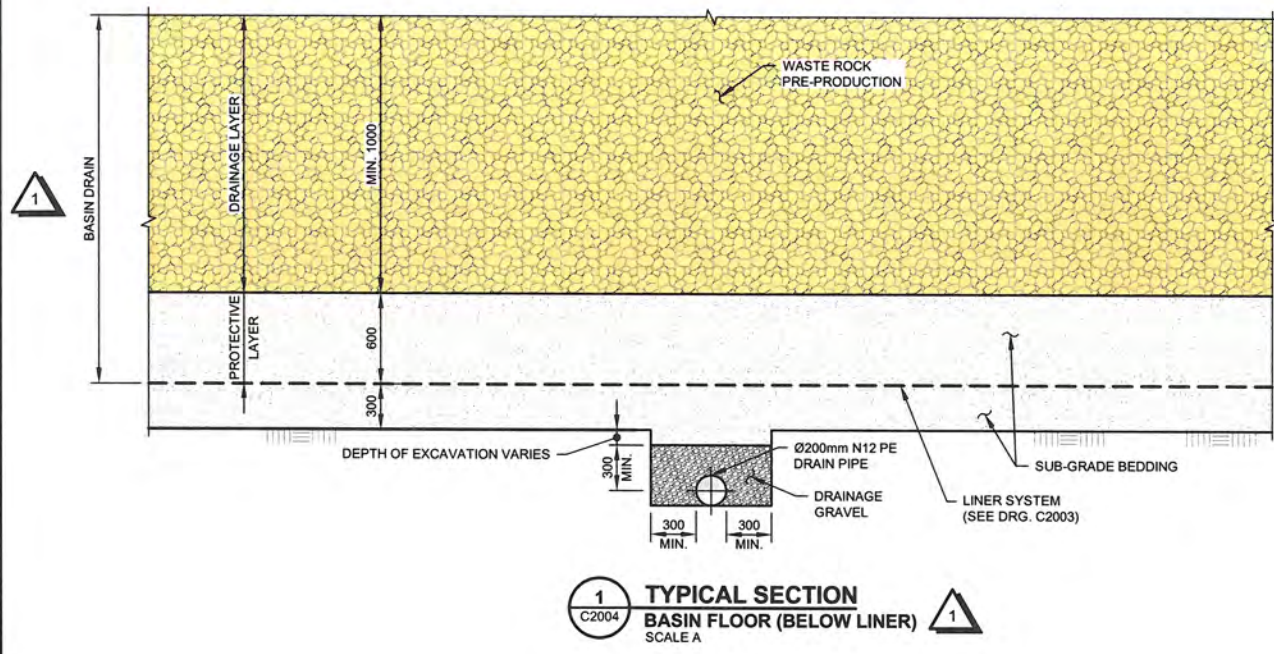

1
 C2004 **TYPICAL SECTION**
BASIN FLOOR (BELOW LINER)
 SCALE A

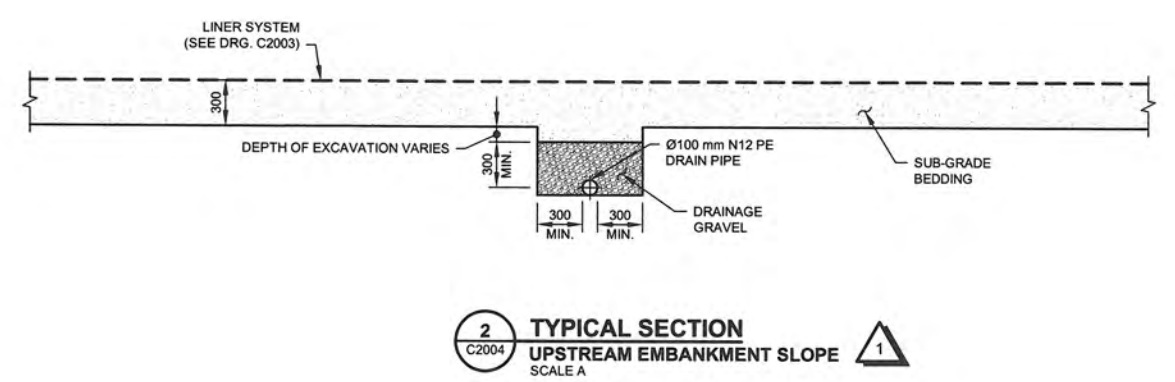

2
 C2004 **TYPICAL SECTION**
UPSTREAM EMBANKMENT SLOPE
 SCALE A

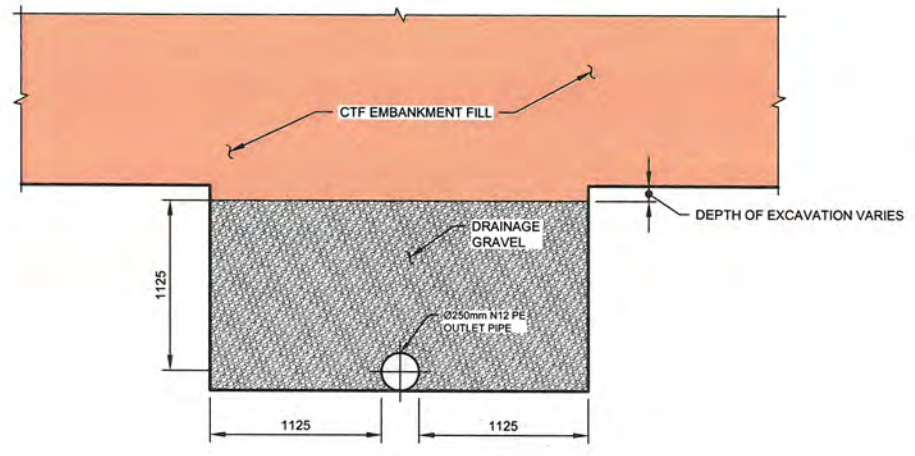

3
 C2004 **TYPICAL SECTION**
OUTLET PIPE (BELOW EMBANKMENT FILL)
 SCALE A

CTF FOUNDATION DRAIN SUMMARY TABLE			
PIPE TYPE	PIPE OUTER DIAMETER (mm)	D	
		NOMINAL DIAMETER	T
			DRAINAGE GRAVEL THICKNESS (mm)
BASIN FLOOR	231.1	8" (200mm)	300
UPSTREAM EMBANKMENT SLOPE	121.9	4" (100mm)	300
OUTLET PIPE	289.6	10" (250mm)	1125

- NOTES:**
- DIMENSIONS ARE IN MILLIMETERS, UNLESS NOTED OTHERWISE.
 - DRAIN PIPE ARE N12 ST PE PIPE (OR SIMILAR).
 - OUTLET PIPE IS N12 WT PE PIPE (OR SIMILAR).
 - THE WASTE ROCK MAKING UP THE DRAINAGE LAYER DOES NOT HAVE ANY MATERIAL OR COMPACTION SPECIFICATIONS.

FOR INFORMATION ONLY

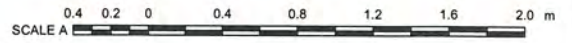

- DISCLAIMER -

THIS DRAWING WAS PREPARED BY KNIGHT PIESOLD LTD. FOR THE ACCOUNT OF THE CLIENT LISTED ON THIS DRAWING. THE MATERIAL ON IT REFLECTS KNIGHT PIESOLD'S BEST JUDGMENT IN THE LIGHT OF THE INFORMATION AVAILABLE TO IT AT THE TIME OF PREPARATION. ANY USE WHICH A THIRD PARTY MAKES OF THIS DRAWING, OR ANY RELIANCE ON OR DECISIONS TO BE MADE BASED ON IT, ARE THE RESPONSIBILITY OF SUCH THIRD PARTIES. KNIGHT PIESOLD ACCEPTS NO RESPONSIBILITY FOR DAMAGES, IF ANY, SUFFERED BY THE THIRD PARTY AS A RESULT OF DECISIONS MADE OR ACTIONS BASED ON THIS DRAWING. COPIES RESULTING FROM ELECTRONIC TRANSFER OR REPRODUCTION OF THIS DRAWING ARE UNCONTROLLED AND MAY NOT BE THE MOST RECENT REVISION OF THIS DRAWING.

Knightsold
CONSULTING

TINTINA RESOURCES INC.

BLACK BUTTE COPPER PROJECT

**CEMENTED TAILINGS FACILITY
FOUNDATION DRAIN
SECTIONS**

DRG. NO.	DESCRIPTION	REV	DATE	DESIGNED	DRAWN	REVIEWED	APPROVED
VA101-460/3	C2006						

C5002	PWP DIVERSION CHANNEL - PLAN AND PROFILE
C5001	CTF DIVERSION CHANNEL - PLAN AND PROFILE
C2004	CTF BASIN FOUNDATION DRAIN SYSTEM - PLAN

REV	DATE	DESCRIPTION	DESIGNED	DRAWN	REVIEWED	APPROVED
1	20APR'17	NOTES AND LABELS REVISED	GIM	RAF	<i>hw</i>	<i>K.</i>
0	15OCT'15	ISSUED FOR MOP APPLICATION	JSL	NSD	KDE	KDE

REV	DATE	DESCRIPTION	DESIGNED	DRAWN	REVIEWED	APPROVED
1	20APR'17	NOTES AND LABELS REVISED	GIM	RAF	<i>hw</i>	<i>K.</i>
0	15OCT'15	ISSUED FOR MOP APPLICATION	JSL	NSD	KDE	KDE

SAV: M:\11046003\Acad\DWGS\C2008\C2008_13_4\2017 3:58:28 PM - RFAHAM PRINTED: 4/20/2017 3:58:06 PM. C2008 - RFAHAM
 XREF FILE(S): Topo, Im, CTF, S1, CTF, S2, PWP, Dish, Filter, CTF - POND, CTF - SUMP, ACCESS RD AND HAUL RD, ACCESS ROAD RAMP IMAGE FILE(S)

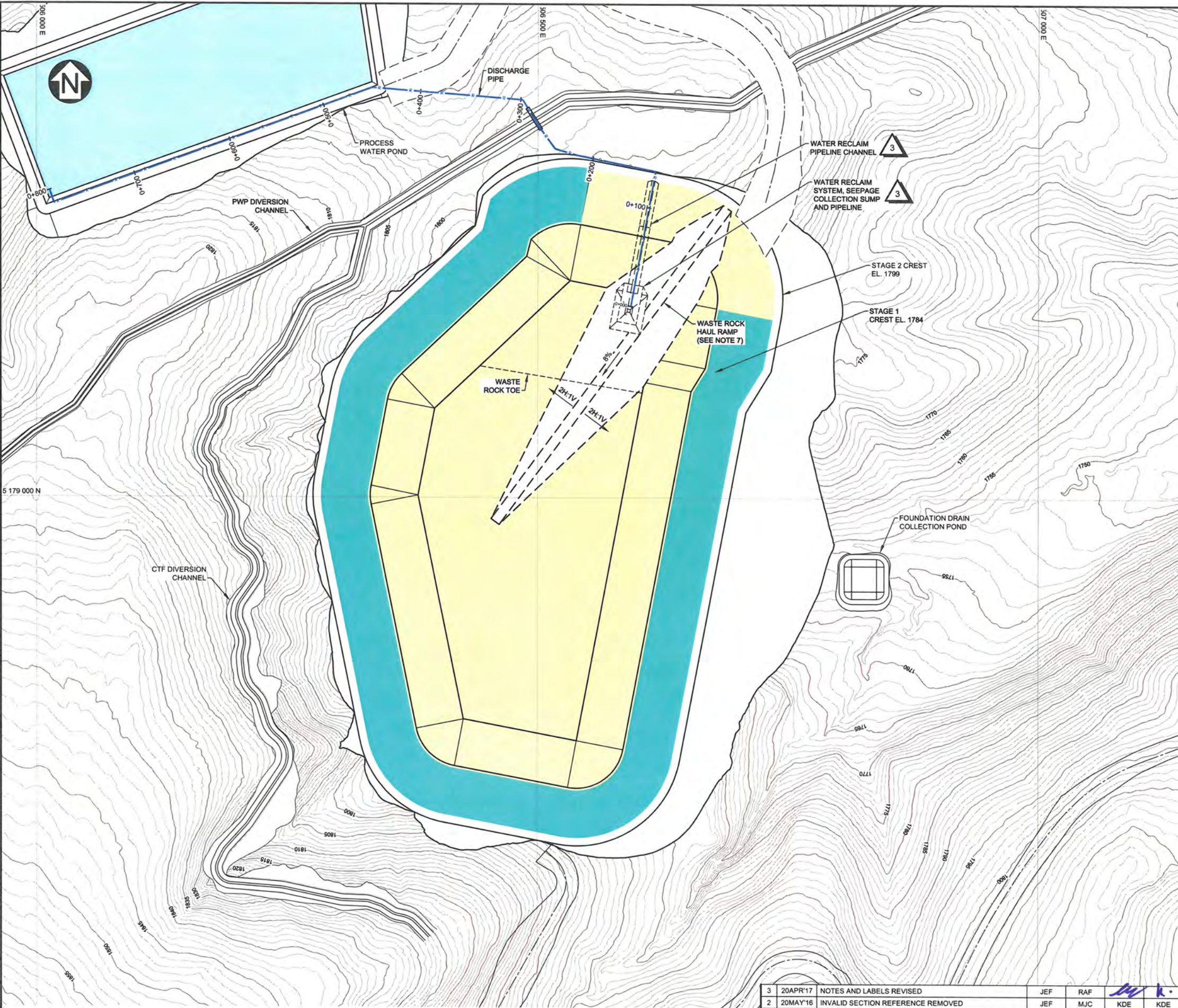

LEGEND:

- STAGE 1 LINER SYSTEM
- STAGE 2 LINER SYSTEM

NOTES:

1. COORDINATE GRID IS UTM NAD83 ZONE 12.
2. PLAN BASED ON INFORMATION PROVIDED BY TINTINA RESOURCES INC., DATED FEBRUARY 3, 2011.
3. CONTOUR INTERVAL IS 1 METER.
4. DIMENSIONS AND ELEVATIONS ARE IN METERS, UNLESS NOTED OTHERWISE.
5. WASTE ROCK WILL BE PLACED AROUND WATER RECLAIM SYSTEM AND SEEPAGE COLLECTION SUMP IN SUCH A MANNER AS TO PREVENT INUNDATION OF THE RECLAIM SYSTEM BY TAILINGS.
6. WASTE ROCK WILL BE PLACED OR SIDE CAST OFF HAUL RAMP AS NEEDED.
7. HAUL RAMP WILL BE CONSTRUCTED USING SURPLUS FILL FROM CTF EXCAVATION DETAILS TO BE FINALIZED WITH MINE OPERATOR.

FOR INFORMATION ONLY



- DISCLAIMER -
 THIS DRAWING WAS PREPARED BY KNIGHT PIESOLD LTD. FOR THE ACCOUNT OF THE CLIENT LISTED ON THIS DRAWING. THE MATERIAL ON IT REFLECTS KNIGHT PIESOLD'S BEST JUDGMENT IN THE LIGHT OF THE INFORMATION AVAILABLE TO IT AT THE TIME OF PREPARATION. ANY USE, WHICH A THIRD PARTY MAKES OF THIS DRAWING, OR ANY RELIANCE ON OR DECISIONS TO BE MADE BASED ON IT, ARE THE RESPONSIBILITY OF SUCH THIRD PARTIES. KNIGHT PIESOLD ACCEPTS NO RESPONSIBILITY FOR DAMAGES, IF ANY, SUFFERED BY THE THIRD PARTY AS A RESULT OF DECISIONS MADE OR ACTIONS BASED ON THIS DRAWING. COPIES RESULTING FROM ELECTRONIC TRANSFER OR REPRODUCTION OF THIS DRAWING ARE UNCONTROLLED AND MAY NOT BE THE MOST RECENT REVISION OF THIS DRAWING.

Knight Piésold

CONSULTING

TINTINA RESOURCES INC.

BLACK BUTTE COPPER PROJECT

CEMENTED TAILINGS FACILITY
WASTE ROCK CO-DISPOSAL PLATFORM
PLAN

REV	DATE	DESCRIPTION	DESIGNED	DRAWN	REVIEWED	APPROVED
3	20APR'17	NOTES AND LABELS REVISED	JEF	RAF	<i>[Signature]</i>	KDE
2	20MAY'16	INVALID SECTION REFERENCE REMOVED	JEF	MJC	KDE	KDE
1	29APR'16	CTF FOUNDATION DRAIN POND REVISED	MAP	RAP	KDE	KDE
0	15OCT'15	ISSUED FOR MOP APPLICATION	GIM	PP	KDE	KDE

DRG. NO.	DESCRIPTION	REV	DATE	DESCRIPTION	DESIGNED	DRAWN	REVIEWED	APPROVED
	REFERENCE DRAWINGS							
	REVISIONS							

PIA NO. VA101-460/3	DRAWING NO. C2008	REVISION 3
-------------------------------	-----------------------------	----------------------

SAV: M:\1010046003\AA\ao\DWGS\C2010\C2010_12_4\272017 3:11:29 PM, WLAHODA PRINTED: 4/27/2017 3:23:13 PM, C2010, WLAHODA
 REF FILES: IMAGE FILES

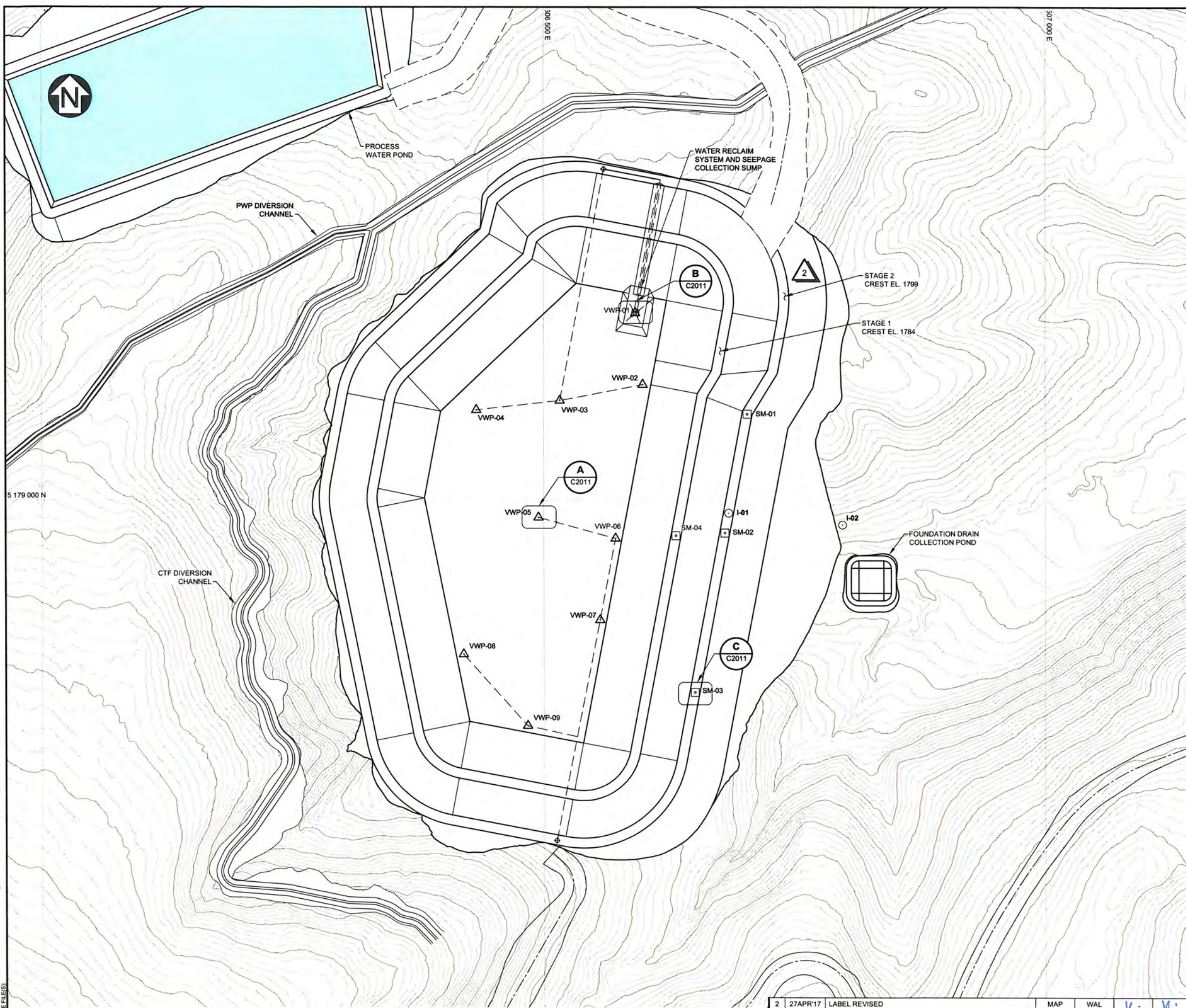

- LEGEND:**
- VIBRATING WIRE PIEZOMETER
 - SURVEY MONUMENT
 - INCLINOMETER
 - VIBRATING WIRE PIEZOMETER READ OUT BOX
 - VIBRATING WIRE PIEZOMETER LEADS

- NOTES:**
1. COORDINATE GRID IS UTM NAD83 ZONE 12.
 2. CONTOUR INTERVAL IS 1 METER.
 3. DIMENSIONS AND ELEVATIONS ARE IN METERS, UNLESS NOTED OTHERWISE.
 4. FILL CONTOURS NOT SHOWN FOR CLARITY.

FOR INFORMATION ONLY

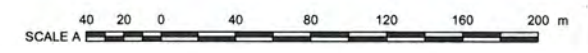

- DISCLAIMER -
 THIS DRAWING WAS PREPARED BY KNIGHT PIESOLD LTD. FOR THE ACCOUNT OF THE CLIENT LISTED ON THIS DRAWING. THE MATERIAL ON IT REFLECTS KNIGHT PIESOLD'S BEST JUDGEMENT IN THE LIGHT OF THE INFORMATION AVAILABLE TO IT AT THE TIME OF PREPARATION. ANY USE WHICH A THIRD PARTY MAKES OF THIS DRAWING, OR ANY RELIANCE ON OR DECISIONS TO BE MADE BASED ON IT, ARE THE RESPONSIBILITY OF SUCH THIRD PARTIES. KNIGHT PIESOLD ACCEPTS NO RESPONSIBILITY FOR DAMAGES, IF ANY, SUFFERED BY THE THIRD PARTY AS A RESULT OF DECISIONS MADE OR ACTIONS BASED ON THIS DRAWING. COPIES RESULTING FROM ELECTRONIC TRANSFER OR REPRODUCTION OF THIS DRAWING ARE UNCONTROLLED AND MAY NOT BE THE MOST RECENT REVISION OF THIS DRAWING.

Knight Piesold
CONSULTING

TINTINA RESOURCES INC.

BLACK BUTTE COPPER PROJECT

CEMENTED TAILINGS FACILITY
INSTRUMENTATION
PLAN

C2011	CEMENTED TAILINGS FACILITY INSTRUMENTATION DETAILS
DRG. NO.	DESCRIPTION
REFERENCE DRAWINGS	

REV	DATE	DESCRIPTION	DESIGNED	DRAWN	REVIEWED	APPROVED
REVISIONS						

REV	DATE	DESCRIPTION	DESIGNED	DRAWN	REVIEWED	APPROVED
2	27APR'17	LABEL REVISED	MAP	WAL	V. KDE	V. KDE
1	29APR'16	CTF FOUNDATION DRAIN POND REVISED	MAP	RAP	V. KDE	V. KDE
0	15OCT'15	ISSUED FOR MOP APPLICATION	GIM	PP	KDE	KDE
REVISIONS						

PIA NO.

VA101-460/3

DRAWING NO.
C2010

REVISION
2

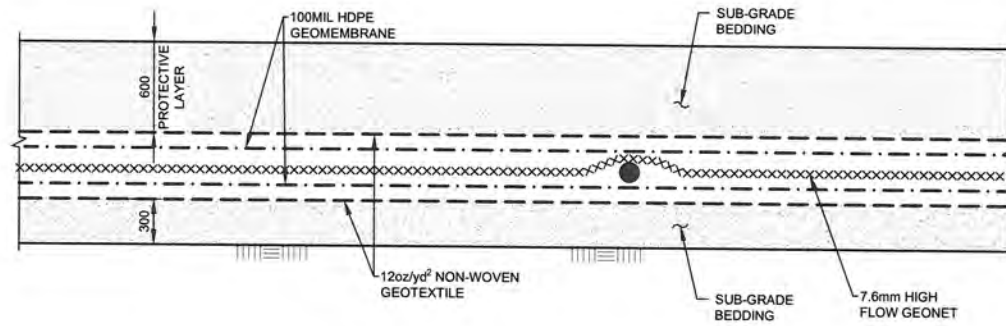

A
C2010
DETAIL
TYPICAL VIBRATING WIRE PIEZOMETER
INSTALLATION IN BASIN DRAIN
SCALE A

SUMMARY OF VIBRATING WIRE PIEZOMETER INSTALLATIONS					
IDENTIFICATION	LEAD LENGTH	LOCATION			DATE INSTALLED
		EASTING (m)	NORTHING (m)	ELEVATION (m)	
VWP-01	-	506,591	5,179,187	1762.8	-
VWP-02	-	506,598	5,179,115	1763.1	-
VWP-03	-	506,515	5,179,099	1763.3	-
VWP-04	-	506,433	5,179,090	1763.4	-
VWP-05	-	506,494	5,178,982	1763.9	-
VWP-06	-	506,571	5,178,961	1763.9	-
VWP-07	-	506,555	5,178,880	1764.3	-
VWP-08	-	506,420	5,178,846	1764.6	-
VWP-09	-	506,483	5,178,774	1764.9	-

SUMMARY OF SURVEY MOMUMENT INSTALLATIONS				
IDENTIFICATION	LOCATION			DATE INSTALLED
	EASTING (m)	NORTHING (m)	ELEVATION (m)	
SM-01	506,703	5,179,086	1799	-
SM-02	506,680	5,178,967	1799	-
SM-03	506,650	5,178,808	1799	-
SM-04	506,631	5,178,964	1784	-

SUMMARY OF SURVEY INCLINOMETERS INSTALLATIONS				
IDENTIFICATION	LOCATION			DATE INSTALLED
	EASTING (m)	NORTHING (m)	ELEVATION (m)	
I-01	506684	5,178,987	1799	-
I-02	506798	5,178,975	1758	-

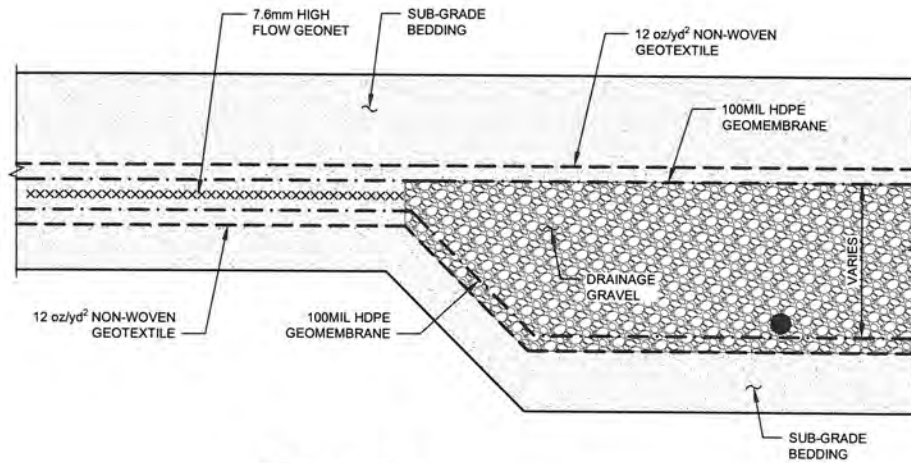

B
C2010
DETAIL
TYPICAL VIBRATING WIRE PIEZOMETER
INSTALLATION IN SEEPAGE COLLECTION SUMP
SCALE A

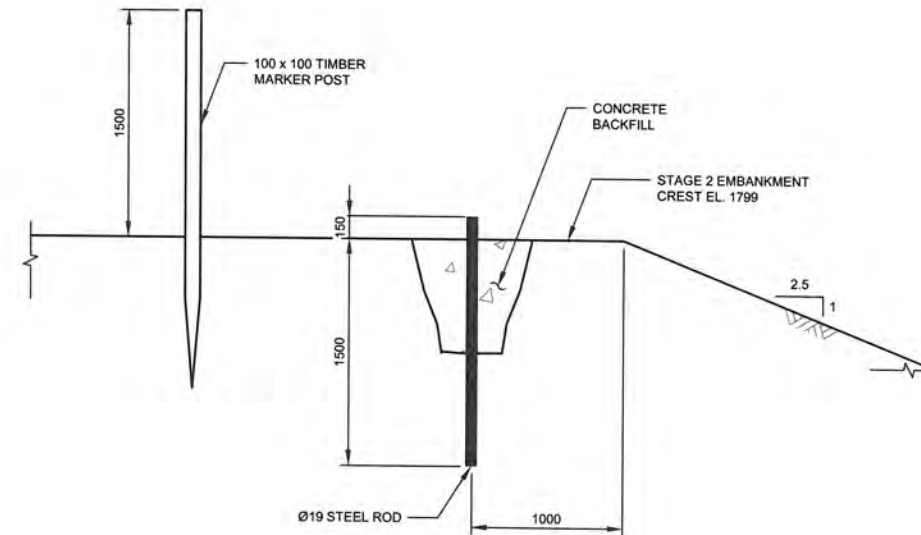

C
C2010
DETAIL
TYPICAL SURVEY MONUMENT INSTALLATION
SCALE A

LEGEND:

- VIBRATING WIRE PIEZOMETER TIP

NOTES:

- COORDINATE GRID IS UTM NAD83 ZONE 12.
- DIMENSIONS ARE IN MILLIMETERS, UNLESS NOTED OTHERWISE.
- VIBRATING WIRE PIEZOMETER TIP AND CABLE TO BE SECURELY TAPED TO GEOMEMBRANE.
- INCLINOMETERS TO BE INSTALLED AFTER CONSTRUCTION BY QUALIFIED CONTRACTORS.

FOR INFORMATION ONLY



- DISCLAIMER -
THIS DRAWING WAS PREPARED BY KNIGHT PIESOLD LTD. FOR THE ACCOUNT OF THE CLIENT LISTED ON THIS DRAWING. THE MATERIAL ON IT REFLECTS KNIGHT PIESOLD'S BEST JUDGMENT IN THE LIGHT OF THE INFORMATION AVAILABLE TO IT AT THE TIME OF PREPARATION. ANY USE WHICH A THIRD PARTY MAKES OF THIS DRAWING OR ANY RELIANCE ON OR DECISIONS TO BE MADE BASED ON IT, ARE THE RESPONSIBILITY OF SUCH THIRD PARTIES. KNIGHT PIESOLD ACCEPTS NO RESPONSIBILITY FOR DAMAGES, IF ANY, SUFFERED BY THE THIRD PARTY AS A RESULT OF DECISIONS MADE OR ACTIONS BASED ON THIS DRAWING. COPIES RESULTING FROM ELECTRONIC TRANSFER OR REPRODUCTION OF THIS DRAWING ARE UNCONTROLLED AND MAY NOT BE THE MOST RECENT REVISION OF THIS DRAWING.

Knight Piesold
CONSULTING

TINTINA RESOURCES INC.

BLACK BUTTE COPPER PROJECT

**CEMENTED TAILINGS FACILITY
INSTRUMENTATION
SECTIONS AND DETAILS**

PIA NO. **VA101-460/3** DRAWING NO. **C2011** REVISION **2**

REV	DATE	DESCRIPTION	DESIGNED	DRAWN	REVIEWED	APPROVED
2	20APR17	NOTES AND LABELS REVISED	GIM	RAF	[Signature]	[Signature]
1	20JUL16	DETAIL B - NOTE REVISED	GIM	WAL	KDE	KDE
0	15OCT15	ISSUED FOR MOP APPLICATION	GIM	PP	KDE	KDE

DRG. NO.	DESCRIPTION	REV	DATE	DESCRIPTION	DESIGNED	DRAWN	REVIEWED	APPROVED
C2010	CEMENTED TAILINGS FACILITY INSTRUMENTATION PLAN							
REFERENCE DRAWINGS				REVISIONS				

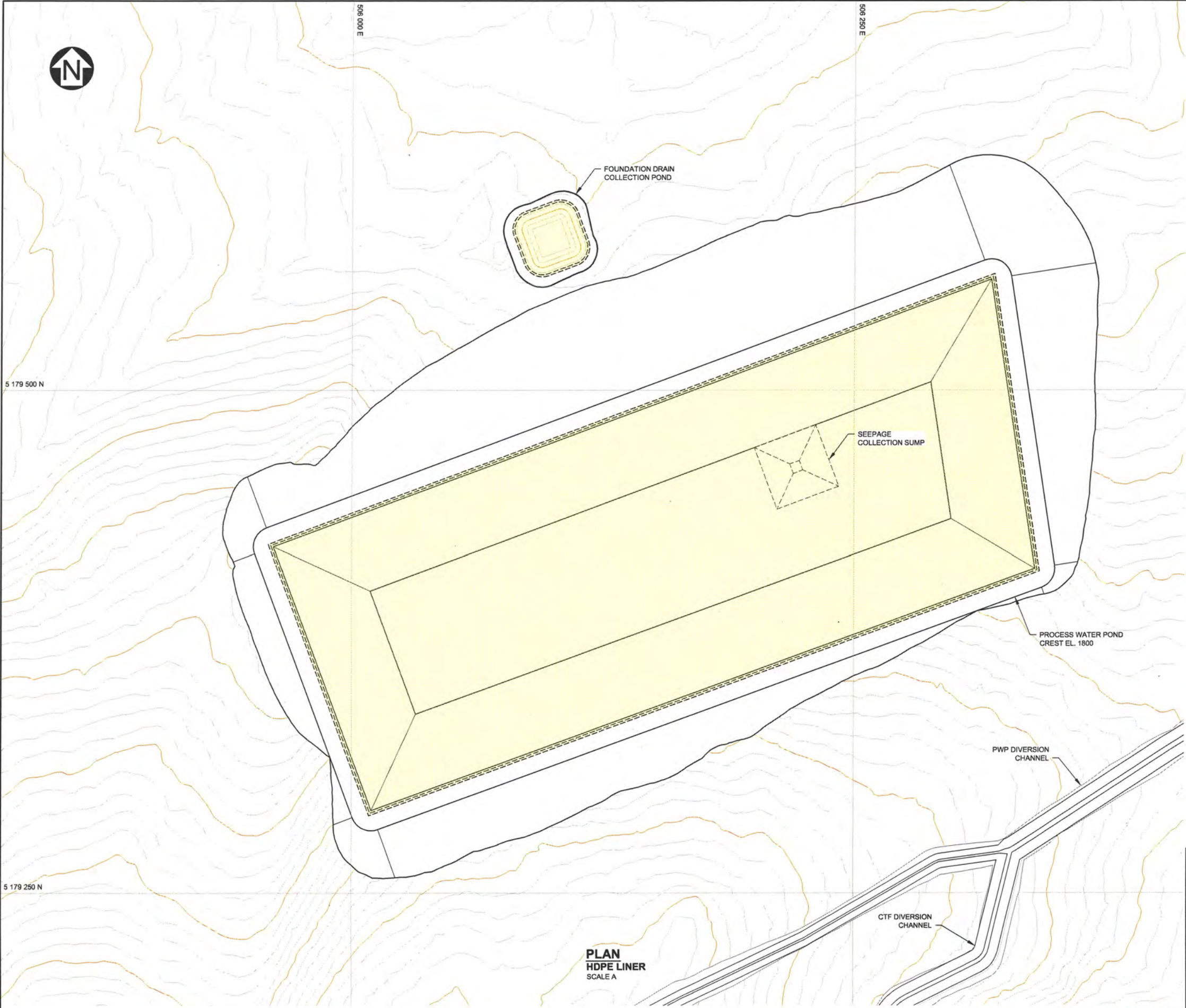

PLAN
HDPE LINER
SCALE A

LEGEND:

- HDPE LINER
- LINER SYSTEM ANCHOR TRENCH

NOTES:

1. COORDINATE GRID IS UTM NAD83 ZONE 12.
2. PLAN BASED ON INFORMATION PROVIDED BY TINTINA RESOURCES INC., DATED FEB 03, 2011.
3. CONTOUR INTERVAL IS 1 METER.
4. DIMENSIONS AND ELEVATIONS ARE IN METERS, UNLESS NOTED OTHERWISE.
5. HDPE LINER CONFIGURATION SHOWN ON DRG. C3005.

FOR INFORMATION ONLY

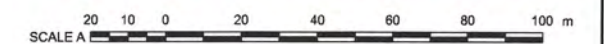

- DISCLAIMER -

THIS DRAWING WAS PREPARED BY KNIGHT PIESOLD LTD. FOR THE ACCOUNT OF THE CLIENT LISTED ON THIS DRAWING. THE MATERIAL ON IT REFLECTS KNIGHT PIESOLD'S BEST JUDGEMENT IN THE LIGHT OF THE INFORMATION AVAILABLE TO IT AT THE TIME OF PREPARATION. ANY USE WHICH A THIRD PARTY MAKES OF THIS DRAWING OR ANY RELIANCE ON OR DECISIONS TO BE MADE BASED ON IT, ARE THE RESPONSIBILITY OF SUCH THIRD PARTIES. KNIGHT PIESOLD ACCEPTS NO RESPONSIBILITY FOR DAMAGES, IF ANY, SUFFERED BY THE THIRD PARTY AS A RESULT OF DECISIONS MADE OR ACTIONS BASED ON THIS DRAWING. COPIES RESULTING FROM ELECTRONIC TRANSFER OR REPRODUCTION OF THIS DRAWING ARE UNCONTROLLED AND MAY NOT BE THE MOST RECENT REVISION OF THIS DRAWING.

Knight Piesold
CONSULTING

TINTINA RESOURCES INC.

BLACK BUTTE COPPER PROJECT

**PROCESS WATER POND
HDPE LINER AND SEEPAGE COLLECTION
LAYOUT PLAN**

C3001	PROCESS WATER POND GRADING PLAN	REV	DATE	DESCRIPTION	DESIGNED	DRAWN	REVIEWED	APPROVED	REV	DATE	DESCRIPTION	DESIGNED	DRAWN	REVIEWED	APPROVED
	REFERENCE DRAWINGS										REVISIONS				
											REVISIONS				

PIA NO.	DRAWING NO.	REVISION
VA101-460/3	C3002	0

SAVER: M:\110100460\03\A\Acad\DWG\C3002\C3002_10/16/2015 1:41:53 PM - PPETKOVIC PRINTED: 10/16/2015 1:41:59 PM, C3002_PPETKOVIC
 XREF FILE(S): Top, Lin, PWP, Dwg, PWP, Dwg, PROCESS WATER POND, PWP - SUMP, IMAGE FILE(S)

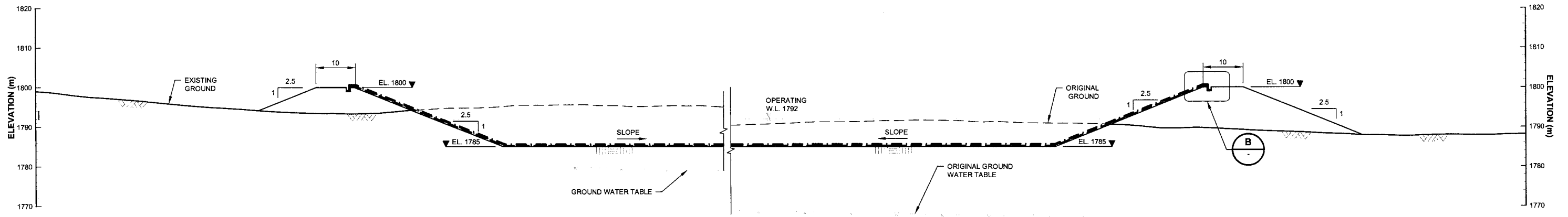

1 SECTION
C3001 SCALE A

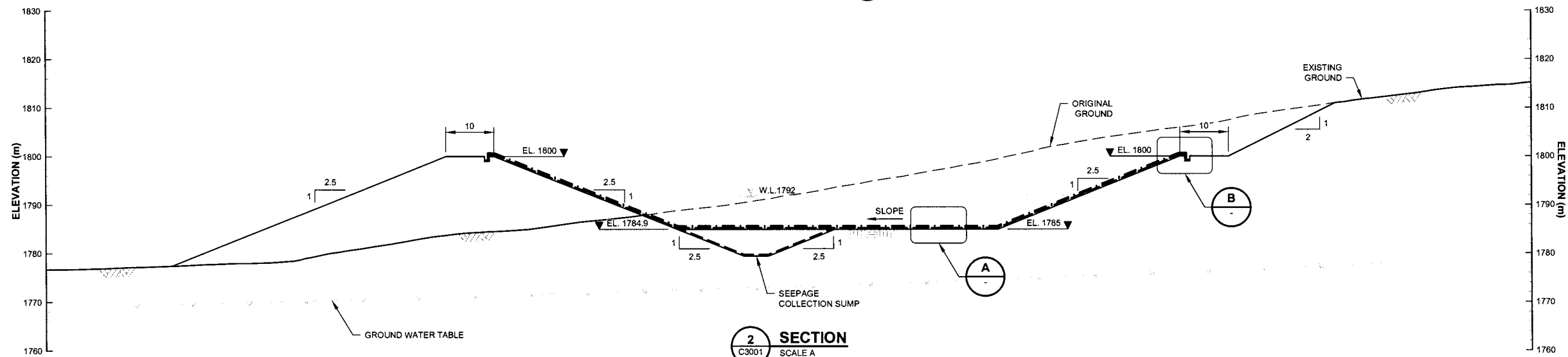

2 SECTION
C3001 SCALE A

- NOTES:**
- DIMENSIONS AND ELEVATIONS ARE IN METERS, UNLESS NOTED OTHERWISE.
 - DEPTH TO GROUNDWATER BELOW PWP FROM POTENTIOMETRIC SURFACE MAP CONTOURS PROVIDED BY HYDROMETRICS (2017).



FOR INFORMATION ONLY

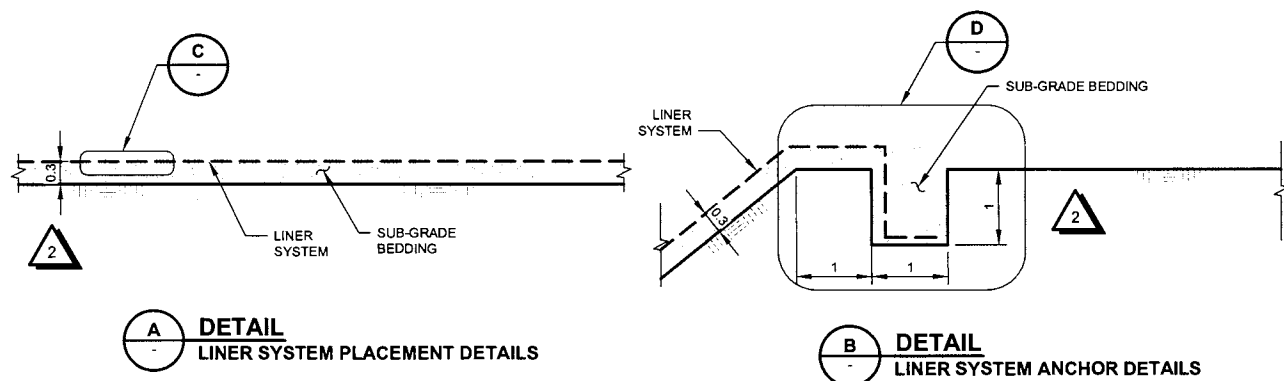
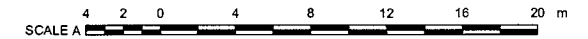

A DETAIL
LINER SYSTEM PLACEMENT DETAILS

B DETAIL
LINER SYSTEM ANCHOR DETAILS

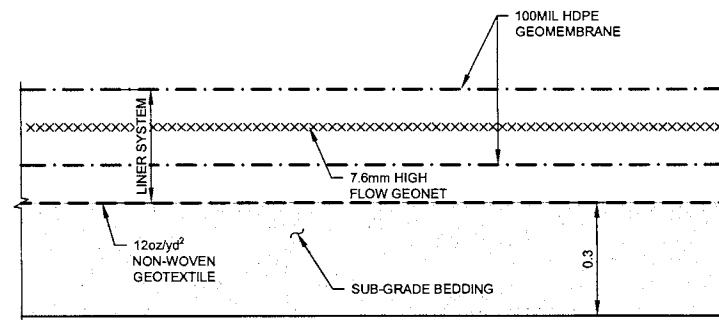

C DETAIL
LINER SYSTEM DETAILS

— DISCLAIMER —
THIS DRAWING WAS PREPARED BY KNIGHT PIESOLD LTD. FOR THE ACCOUNT OF THE CLIENT LISTED ON THIS DRAWING. THE MATERIAL ON IT REFLECTS KNIGHT PIESOLD'S BEST JUDGMENT IN THE LIGHT OF THE INFORMATION AVAILABLE TO IT AT THE TIME OF PREPARATION. ANY USE WHICH A THIRD PARTY MAKES OF THIS DRAWING OR ANY RELIANCE ON OR DECISIONS TO BE MADE BASED ON IT, ARE THE RESPONSIBILITY OF SUCH THIRD PARTIES. KNIGHT PIESOLD ACCEPTS NO RESPONSIBILITY FOR DAMAGES, IF ANY, SUFFERED BY THE THIRD PARTY AS A RESULT OF DECISIONS MADE OR ACTIONS BASED ON THIS DRAWING. COPIES RESULTING FROM ELECTRONIC TRANSFER OR REPRODUCTION OF THIS DRAWING ARE UNCONTROLLED AND MAY NOT BE THE MOST RECENT REVISION OF THIS DRAWING.

Knight Piesold
CONSULTING

TINTINA RESOURCES INC.

BLACK BUTTE COPPER PROJECT

PROCESS WATER POND SECTIONS

PIA NO.	DRAWING NO.	REVISION
VA101-460/3	C3003	2

REV	DATE	DESCRIPTION	DESIGNED	DRAWN	REVIEWED	APPROVED
2	21APR17	NOTES REVISED	GIM	RAF	KDE	KDE
1	29APR16	GROUND WATER TABLE ADDED	GIM	RAP	KDE	KDE
0	15OCT15	ISSUED FOR MOP APPLICATION	GIM	NSD	KDE	KDE

DRG. NO.	DESCRIPTION	REV	DATE	DESCRIPTION	DESIGNED	DRAWN	REVIEWED	APPROVED
C3001	PROCESS WATER POND - GRADING PLAN							

SAVED: M:\110100460\03\Acad\DWGS\C3004\C3004.dwg, 10/15/2015 3:24:47 PM, PPRETKOVIC, PRINTED: 10/15/2015 3:24:55 PM, C3004, PPRETKOVIC
 XREF FILE(S): Hydro, Roads, Topo, Im, Walls, S, NCW, CTF, ST, CTF, SZ, Topo, Dwg, PROCESS WATER POND, PWP, SUMP, IMAGE FILE(S)

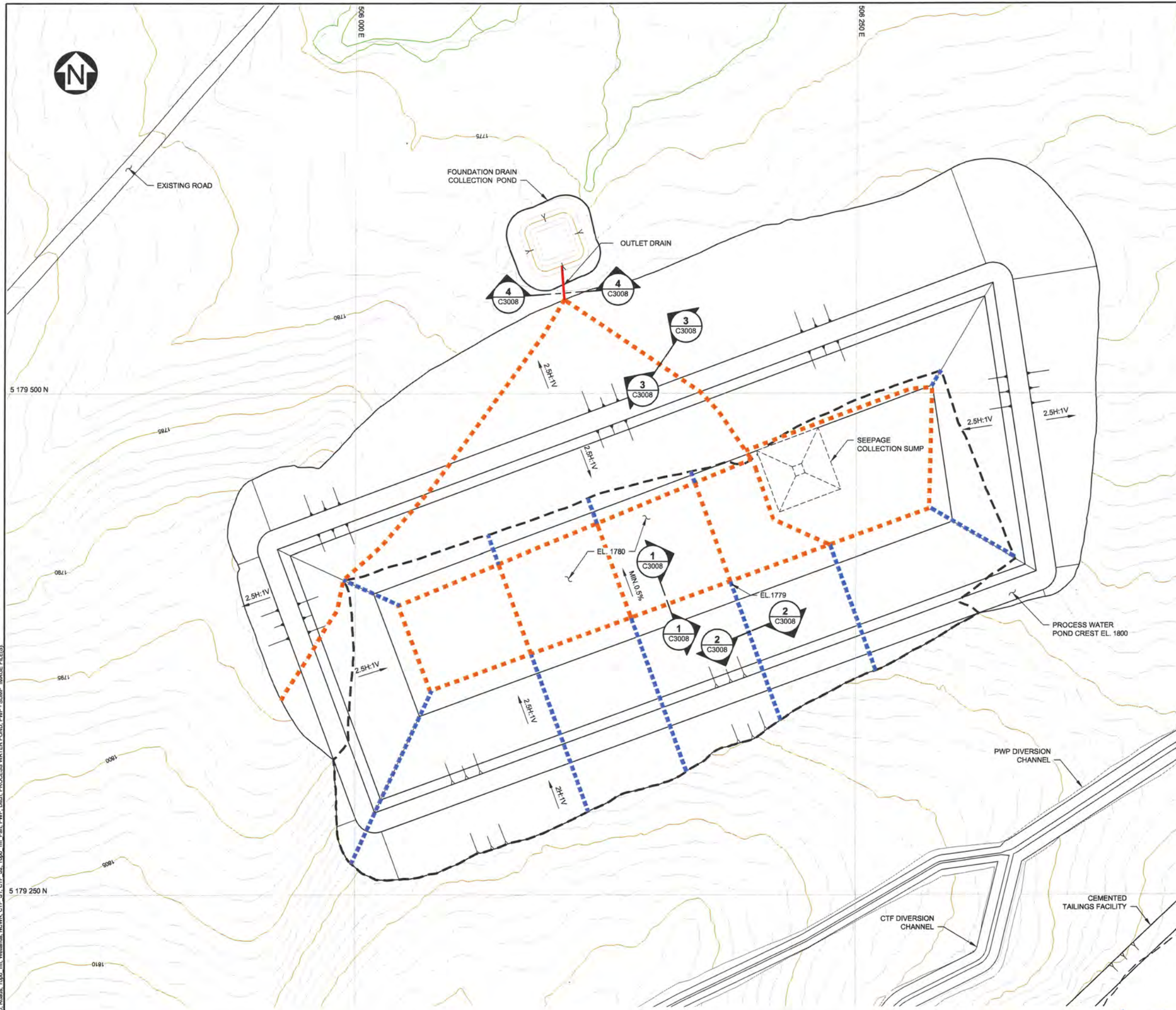

- LEGEND:**
- 6" N12 WT PE OUTLET PIPE
 - - - 6" N12 ST PE DRAIN PIPE (BASIN FLOOR)
 - - - 4" N12 ST PE DRAIN PIPE (SLOPE)
 - - - CUT/FILL TRANSITION

- NOTES:**
1. COORDINATE GRID IS UTM NAD83 ZONE 12.
 2. CONTOUR INTERVAL IS 1 METER.
 3. DIMENSIONS AND ELEVATIONS ARE IN METERS, UNLESS NOTED OTHERWISE.
 4. FILL CONTOURS NOT SHOWN FOR CLARITY.
 5. DRAIN TRENCHES WILL BE SLOPED TOWARDS OUTLET PIPE CONNECTION AT A MINIMUM GRADE OF 0.5%.
 6. LAST 10m OF OUTLET PIPE WILL BE SOLID PIPE BACKFILLED WITH IMPERMEABLE MATERIAL.
 7. OUTLET PIPE WILL EMPTY INTO A WEIR TO MEASURE PIPE FLOW.

FOR INFORMATION ONLY

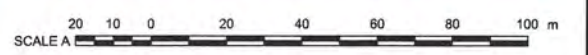

- DISCLAIMER -
 THIS DRAWING WAS PREPARED BY KNIGHT PIESOLD LTD. FOR THE ACCOUNT OF THE CLIENT LISTED ON THIS DRAWING. THE MATERIAL ON IT REFLECTS KNIGHT PIESOLD'S BEST JUDGMENT IN THE LIGHT OF THE INFORMATION AVAILABLE TO IT AT THE TIME OF PREPARATION AND USE WHEREA THIRD PARTY MAKES OF THIS DRAWING OR ANY RELIANCE ON OR DECISIONS TO BE MADE BASED ON IT, ARE THE RESPONSIBILITY OF SUCH THIRD PARTIES. KNIGHT PIESOLD ACCEPTS NO RESPONSIBILITY FOR DAMAGES, IF ANY, SUFFERED BY THE THIRD PARTY AS A RESULT OF DECISIONS MADE OR ACTIONS BASED ON THIS DRAWING. COPIES RESULTING FROM ELECTRONIC TRANSFER OR REPRODUCTION OF THIS DRAWING ARE UNCONTROLLED AND MAY NOT BE THE MOST RECENT REVISION OF THIS DRAWING.

<i>Knightsold</i> CONSULTING		
TINTINA RESOURCES INC.		
BLACK BUTTE COPPER PROJECT		
PROCESS WATER POND BASIN FOUNDATION DRAIN SYSTEM PLAN		
PIA NO.	DRAWING NO.	REVISION
VA101-460/3	C3004	0

C3008 PROCESS WATER POND FOUNDATION DRAIN DETAILS											
DRG. NO.	DESCRIPTION	REV	DATE	DESIGNED	DRAWN	REVIEWED	APPROVED	REV	DATE	DESCRIPTION	
REFERENCE DRAWINGS				REVISIONS				REVISIONS			
								0 15OCT'15 ISSUED FOR MOP APPLICATION GIM NSD			

SAV: M:\110100460\03\AA\Acad\DWG\C3008_4\20\2017 2:52:52 PM - RFAHAM PRINTED: 4/20/2017 4:03:47 PM - C3008 - RFAHAM
 XREF FILE(S): IMAGE FILE(S)

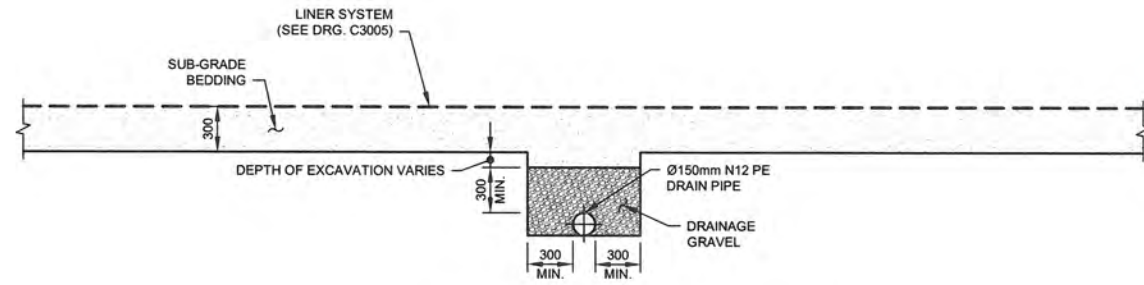

1
 C3004 **TYPICAL SECTION**
BASIN FLOOR (BELOW LINER)
 SCALE A

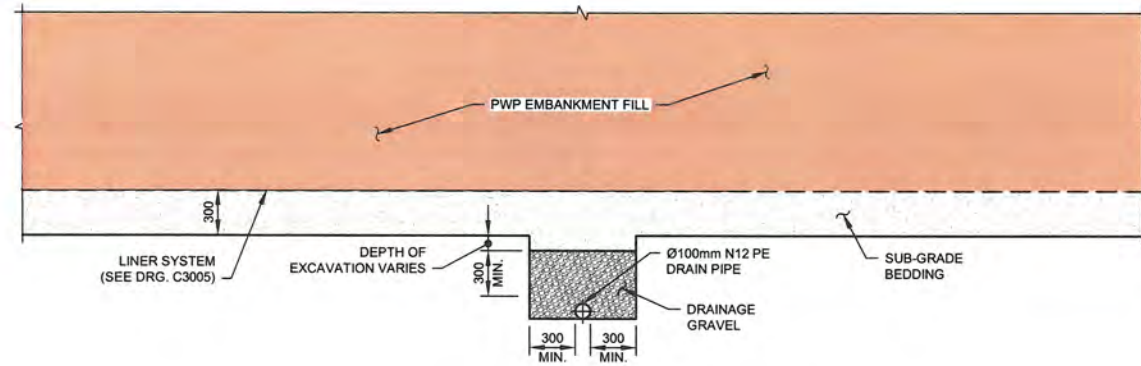

3
 C3004 **TYPICAL SECTION**
BELOW EMBANKMENT FILL
 SCALE A

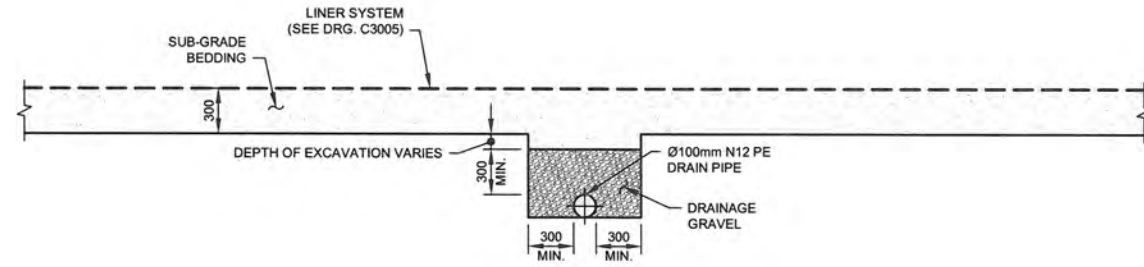

2
 C3004 **TYPICAL SECTION**
UPSTREAM EMBANKMENT SLOPE
 SCALE A

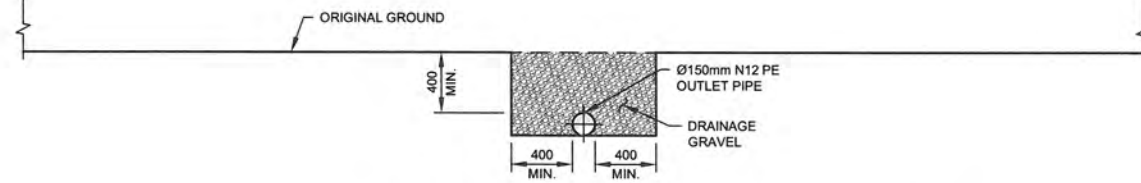

4
 C3004 **TYPICAL SECTION**
OUTLET PIPE (NO OVERLYING EMBANKMENT FILL)
 SCALE A

PWP FOUNDATION DRAIN SUMMARY TABLE			
PIPE TYPE	PIPE OUTER DIAMETER (mm)	D NOMINAL DIAMETER	T DRAINAGE GRAVEL THICKNESS (mm)
BASIN FLOOR	175.3	6" (150mm)	300 - 575
SLOPE PIPE	121.9	4" (100mm)	300
OUTLET PIPE	175.3	6" (150mm)	300 - 400

FOR INFORMATION ONLY

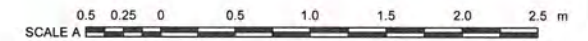

NOTES:

- DIMENSIONS ARE IN MILLIMETERS, UNLESS NOTED OTHERWISE.
- DRAIN PIPES ARE N12 ST PE PIPE (OR SIMILAR APPROVED).
- OUTLET PIPE IS N12 WT PE PIPE (OR SIMILAR APPROVED).

- DISCLAIMER -
 THIS DRAWING WAS PREPARED BY KNIGHT PIESOLD LTD. FOR THE ACCOUNT OF THE CLIENT LISTED ON THIS DRAWING. THE MATERIAL ON IT REFLECTS KNIGHT PIESOLD'S BEST JUDGEMENT IN THE LIGHT OF THE INFORMATION AVAILABLE TO IT AT THE TIME OF PREPARATION. ANY USE WHICH A THIRD PARTY MAKES OF THIS DRAWING, OR ANY RELIANCE ON OR DECISIONS TO BE MADE BASED ON IT, ARE THE RESPONSIBILITY OF SUCH THIRD PARTIES. KNIGHT PIESOLD ACCEPTS NO RESPONSIBILITY FOR DAMAGES, IF ANY, SUFFERED BY THE THIRD PARTY AS A RESULT OF DECISIONS MADE OR ACTIONS BASED ON THIS DRAWING. COPIES RESULTING FROM ELECTRONIC TRANSFER OR REPRODUCTION OF THIS DRAWING ARE UNCONTROLLED AND MAY NOT BE THE MOST RECENT REVISION OF THIS DRAWING.

Knight Piesold
CONSULTING

TINTINA RESOURCES INC.

BLACK BUTTE COPPER PROJECT

**PROCESS WATER POND
FOUNDATION DRAIN DETAILS**

C3004	PROCESS WATER POND BASIN FOUNDATION DRAIN SYSTEM PLAN					
DRG. NO.	DESCRIPTION					
REV	DATE	DESCRIPTION	DESIGNED	DRAWN	REVIEWED	APPROVED
REFERENCE DRAWINGS		REVISIONS				

1	20APR17	SECTION TITLES REVISED	GIM	RAF		
0	15OCT15	ISSUED FOR MOP APPLICATION	GIM	PP	KDE	KDE
REV	DATE	DESCRIPTION	DESIGNED	DRAWN	REVIEWED	APPROVED
REVISIONS			REVISIONS			

P/A NO.	DRAWING NO.	REVISION
VA101-460/3	C3008	1

SAVER: M:\10104603\VA101-4603\DWG\C3010\10162015 10:23:13 AM_PPRKOVIC PRINTED: 10/16/2015 10:23:18 AM, C3010, PPRKOVIC
 XREF FILED: Topo, Lin, PWP, PROCESS WATER POND, Facility, Drain, PWP, SUMP, SUMP, IMAGE FILES

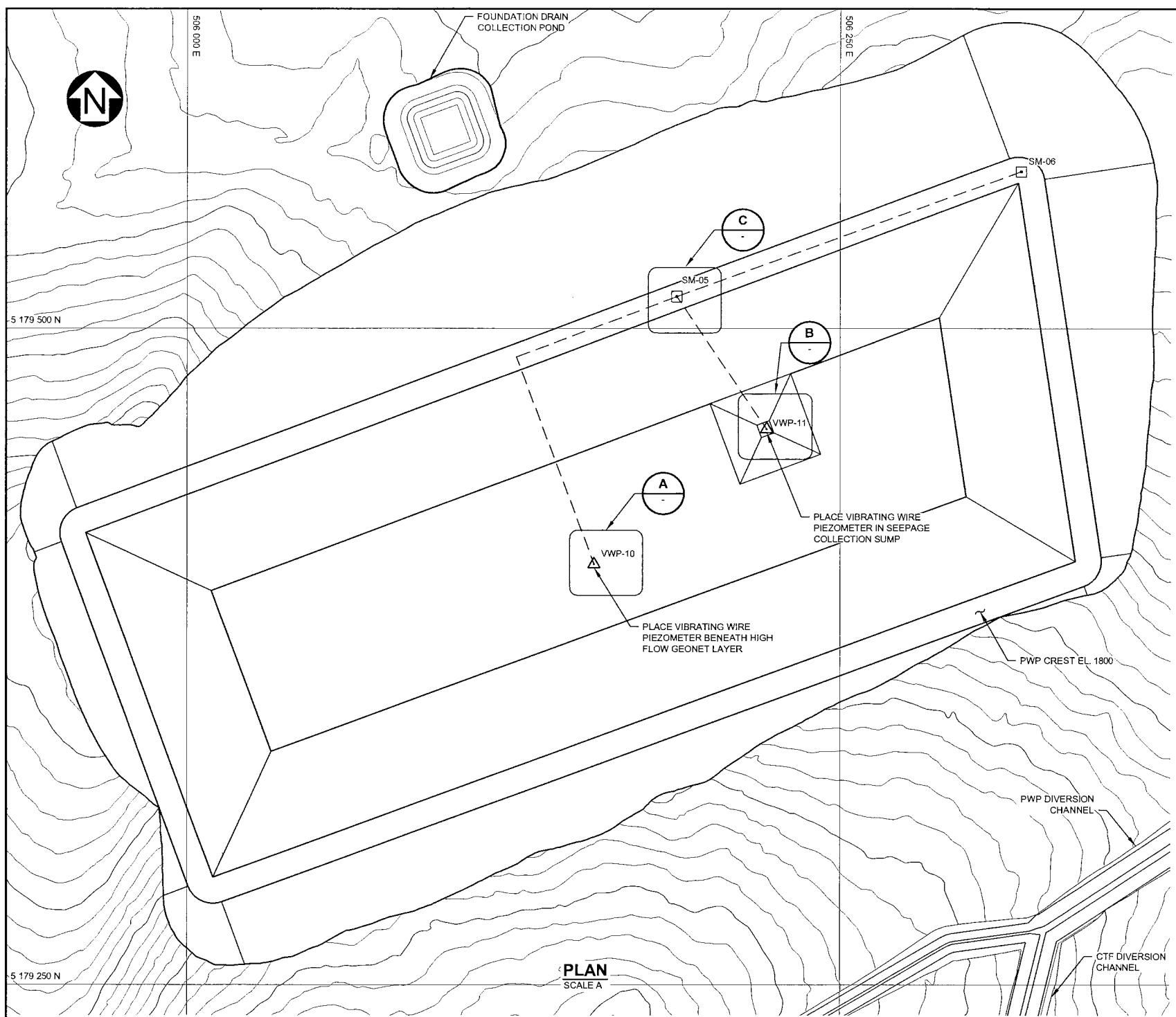

PLAN
SCALE A

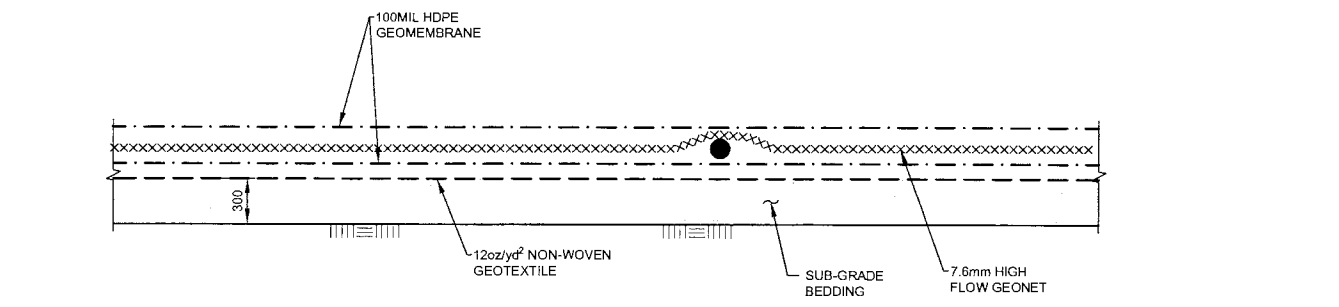

A **DETAIL**
TYPICAL VIBRATING WIRE PIEZOMETER
TO BE SECURELY TAPED TO 100MIL HDPE GEOMEMBRANE
SCALE A

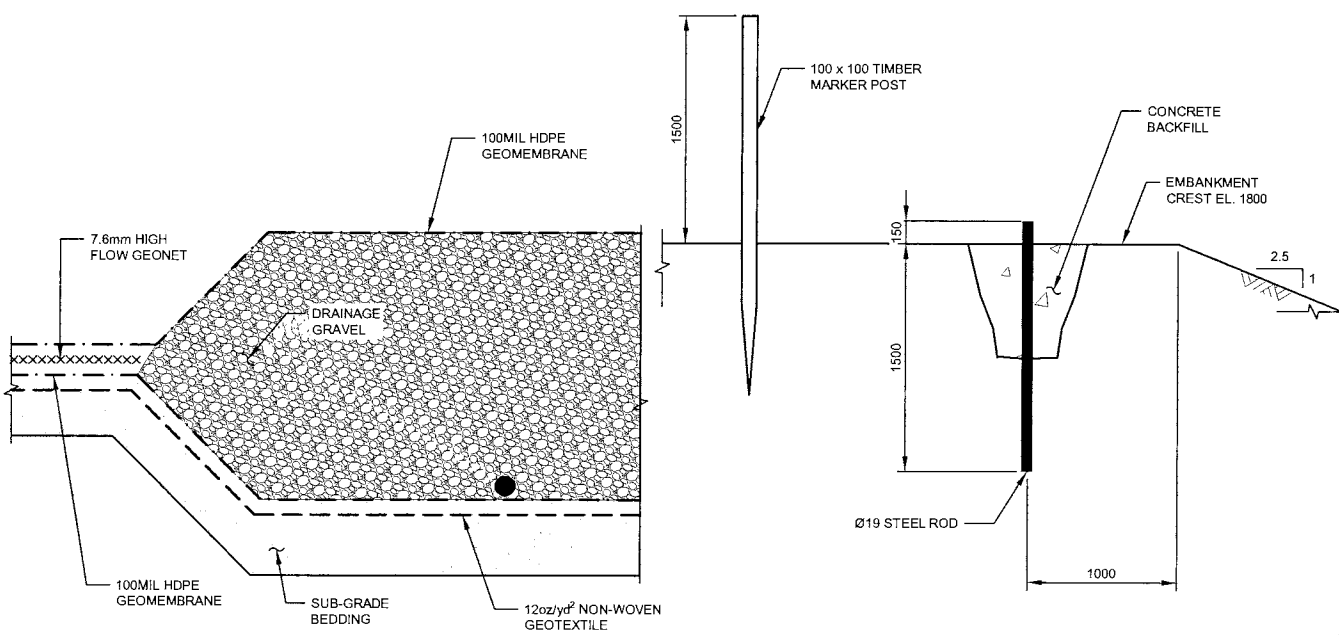

B **DETAIL**
TYPICAL VIBRATIONS WIRE PIEZOMETER
INSTALLATION IN SEEPAGE COLLECTION SUMP
SCALE B

C **DETAIL**
TYPICAL SURVEY MONUMENT INSTALLATION
SCALE A

SUMMARY OF VIBRATING WIRE PIEZOMETER INSTALLATIONS					
IDENTIFICATION	LEAD LENGTH	LOCATION			DATE INSTALLED
		EASTING (m)	NORTHING (m)	ELEVATION (m)	
VWP-10	-	506,155	5,179,410	1780	-
VWP-11	-	506,196	5,179,467	1780	-

SUMMARY OF SURVEY MONUMENT INSTALLATIONS				
IDENTIFICATION	LOCATION			DATE INSTALLED
	EASTING (m)	NORTHING (m)	ELEVATION (m)	
SM-05	506,187	5,179,512	1800	-
SM-06	506,319	5,179,559	1800	-

- LEGEND:**
- △ VIBRATING WIRE PIEZOMETER
 - VIBRATING WIRE PIEZOMETER TIP
 - SURVEY MONUMENT
 - VIBRATING WIRE PIEZOMETER LEADS

- NOTES:**
- COORDINATE GRID IS UTM NAD83 ZONE 12.
 - PLAN BASED ON INFORMATION PROVIDED BY TINTINA RESOURCES INC., DATED FEB 03, 2011.
 - CONTOUR INTERVAL IS 1 METER.
 - DIMENSIONS AND ELEVATIONS ARE IN METERS, UNLESS NOTED OTHERWISE.
 - FILL CONTOURS NOT SHOWN FOR CLARITY.
 - VIBRATING WIRE PIEZOMETER TIP TO BE SECURELY TAPED TO GEOMEMBRANE.

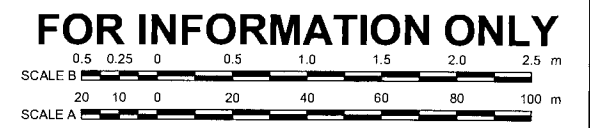

DISCLAIMER
 THIS DRAWING WAS PREPARED BY KNIGHT PIESOLD LTD. FOR THE ACCOUNT OF THE CLIENT LISTED ON THIS DRAWING. THE MATERIAL ON IT REFLECTS KNIGHT PIESOLD'S BEST JUDGEMENT IN THE LIGHT OF THE INFORMATION AVAILABLE TO IT AT THE TIME OF PREPARATION. ANY USE WHICH A THIRD PARTY MAKES OF THIS DRAWING, OR ANY RELIANCE ON OR DECISIONS TO BE MADE BASED ON IT, ARE THE RESPONSIBILITY OF SUCH THIRD PARTIES. KNIGHT PIESOLD ACCEPTS NO RESPONSIBILITY FOR DAMAGES, IF ANY, SUFFERED BY THE THIRD PARTY AS A RESULT OF DECISIONS MADE OR ACTIONS BASED ON THIS DRAWING. COPIES RESULTING FROM ELECTRONIC TRANSFER OR REPRODUCTION OF THIS DRAWING ARE UNCONTROLLED AND MAY NOT BE THE MOST RECENT REVISION OF THIS DRAWING.

Knights Piesold
CONSULTING

TINTINA RESOURCES INC.

BLACK BUTTE COPPER PROJECT

**PROCESS WATER POND
INSTRUMENTATION
LAYOUT PLAN AND DETAILS**

DRG. NO.	DESCRIPTION	DESIGNED	DRAWN	REVIEWED	APPROVED	DATE	DESCRIPTION	DESIGNED	DRAWN	REVIEWED	APPROVED	DATE	DESCRIPTION
C3001	PROCESS WATER POND GRADING PLAN					15OCT'15	ISSUED FOR MOP APPLICATION						

PIA NO.	DRAWING NO.	REVISION
VA101-460/3	C3010	0

SAVEN: M:\10\00460\03\A\Acad\DWGS\C4002\C4002_10\16/2015 1:08:05 PM - PPETKOVIC PRINTED: 10/16/2015 1:08:11 PM, C4002, PPETKOVIC
 XREF FILE(S) : Top, Lin, NCWR, ACCESS RD AND DALE RD, Roads, NCWR-SHLL, IMAGE FILE(S)

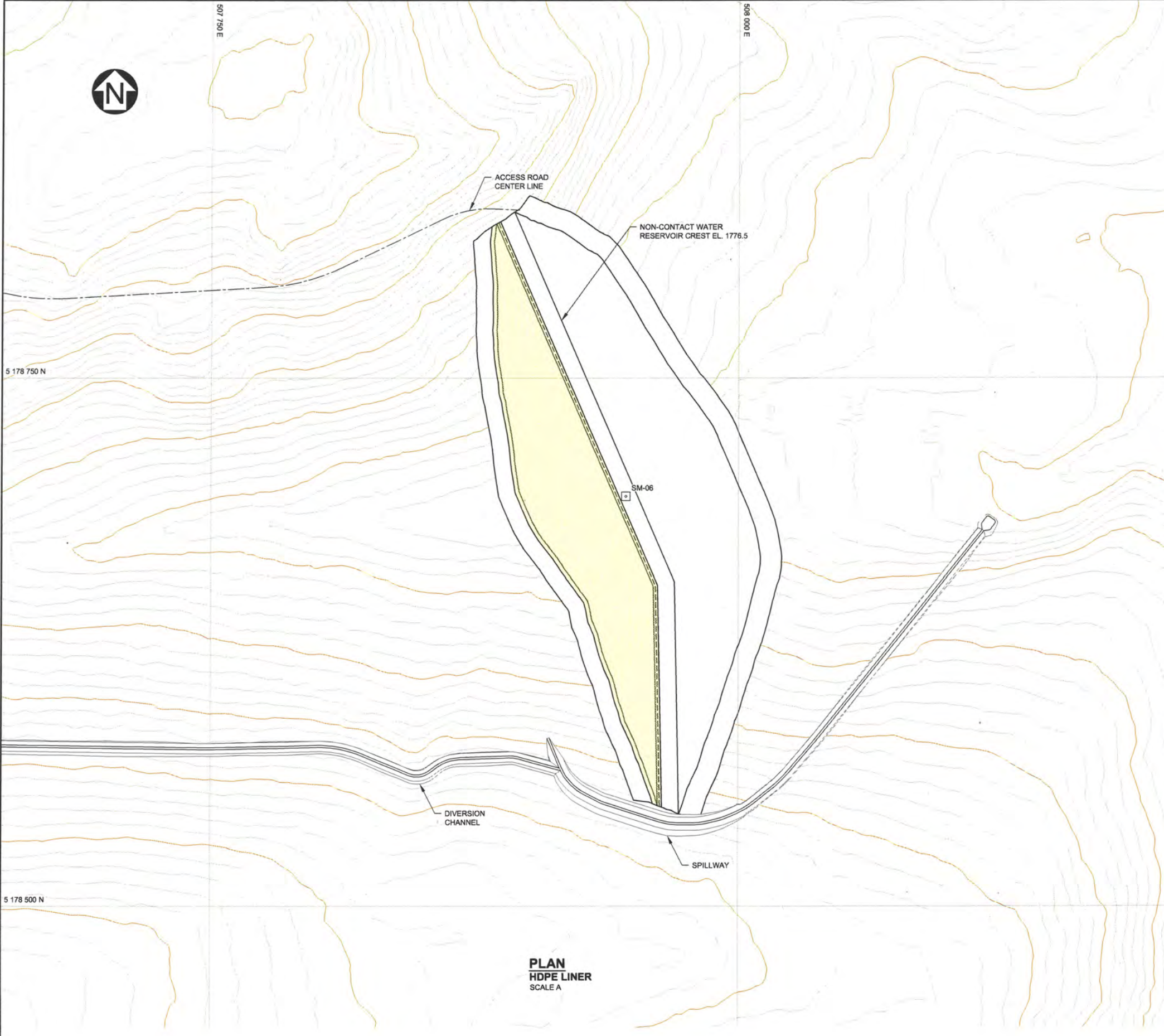

PLAN
HDPE LINER
 SCALE A

SUMMARY OF SURVEY MOMENT INSTALLATIONS				
IDENTIFICATION	LOCATION			DATE INSTALLED
	EASTING (m)	NORTHING (m)	ELEVATION (m)	
SM-06	507,946	5,178,893	1776.5	-

- LEGEND:**
- HDPE LINER
 - SURVEY MONUMENT

- NOTES:**
1. COORDINATE GRID IS UTM NAD83 ZONE 12.
 2. PLAN / SECTION BASED ON INFORMATION PROVIDED BY TIONTINA RESOURCES INC., DATED FEB 03, 2011.
 3. CONTOUR INTERVAL IS 1 METERS.
 4. DIMENSIONS AND ELEVATIONS ARE IN METERS, UNLESS NOTED OTHERWISE.
 5. FILL CONTOURS NOT SHOWN FOR CLARITY.

FOR INFORMATION ONLY

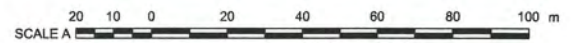

- DISCLAIMER -
 THIS DRAWING WAS PREPARED BY KNIGHT PIESOLD LTD. FOR THE ACCOUNT OF THE CLIENT LISTED ON THIS DRAWING. THE MATERIAL ON IT REFLECTS KNIGHT PIESOLD'S BEST JUDGMENT IN THE LIGHT OF THE INFORMATION AVAILABLE TO IT AT THE TIME OF PREPARATION AND USE WHICH A THIRD PARTY MAKES OF THIS DRAWING OR ANY RELIANCE ON OR DECISIONS TO BE MADE BASED ON IT, ARE THE RESPONSIBILITY OF SUCH THIRD PARTIES. KNIGHT PIESOLD ACCEPTS NO RESPONSIBILITY FOR DAMAGES, IF ANY, SUFFERED BY THE THIRD PARTY AS A RESULT OF DECISIONS MADE OR ACTIONS BASED ON THIS DRAWING. COPIES RESULTING FROM ELECTRONIC TRANSFER OR REPRODUCTION OF THIS DRAWING ARE UNCONTROLLED AND MAY NOT BE THE MOST RECENT REVISION OF THIS DRAWING.

Knight Piesold
 CONSULTING

TINTINA RESOURCES INC.

BLACK BUTTE COPPER PROJECT

NON-CONTACT WATER RESERVOIR
 HDPE LINER AND INSTRUMENTATION
 LAYOUT PLAN

DRG. NO.	DESCRIPTION	REV	DATE	DESIGNED	DRAWN	REVIEWED	APPROVED	REV	DATE	DESCRIPTION	DESIGNED	DRAWN	REVIEWED	APPROVED
C4001	NON-CONTACT WATER RESERVOIR GRADING PLAN							0	15OCT15	ISSUED FOR MOP APPLICATION	GIM	PP	<i>K.</i>	<i>H.</i>
REFERENCE DRAWINGS				REVISIONS				REVISIONS						

PIA NO. VA101-460/3	DRAWING NO. C4002	REVISION 0
-------------------------------	-----------------------------	----------------------

SAVFED: M:\101460\03\VA101460\DWG\C4003\C4003.dwg, 10/15/2015 3:58:08 PM, PPRETKOVIC PRINTED: 10/15/2015 3:58:18 PM, Layout1, PPRETKOVIC
 XREF FILES: IMAGE FILES

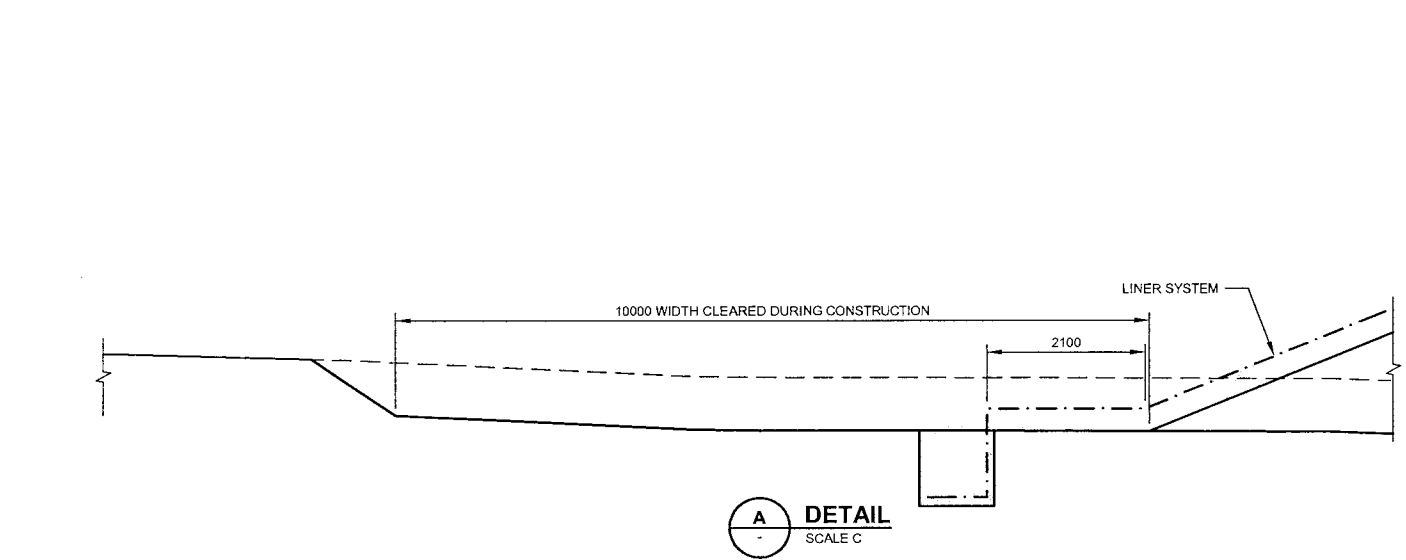
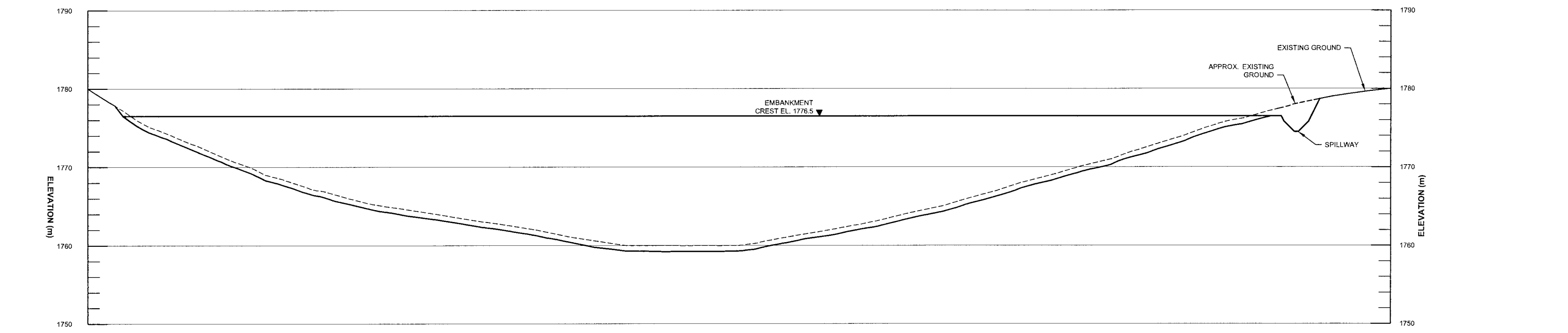
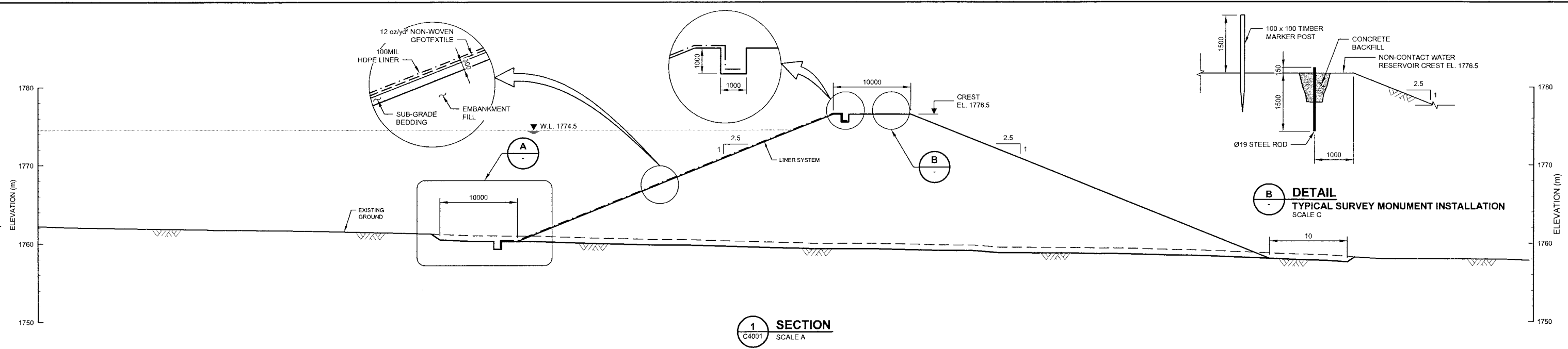

2 SECTION
C4001 SCALE B

- NOTES:**
- DIMENSIONS AND ELEVATIONS ARE IN METERS, UNLESS NOTED OTHERWISE.
 - TOPSOIL AND SUB-SOIL TO BE STRIPPED FROM EMBANKMENT FOOTPRINT.

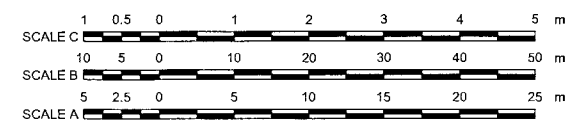

FOR INFORMATION ONLY

- DISCLAIMER -

Knight Piésold
 CONSULTING
 TINTINA RESOURCES INC.
BLACK BUTTE COPPER PROJECT
NON-CONTACT WATER RESERVOIR SECTIONS

PIA NO.	DRAWING NO.	REVISION
VA101-460/3	C4003	0

C4001	NON-CONTACT WATER RESERVOIR GRADING PLAN	REV	DATE	DESCRIPTION	DESIGNED	DRAWN	REVIEWED	APPROVED	REV	DATE	DESCRIPTION	DESIGNED	DRAWN	REVIEWED	APPROVED
	REFERENCE DRAWINGS										ISSUED FOR MOP APPLICATION				

SAVED: M:\1101004603\VA101-460\DWGS\C4004\C4004.dwg, 10/15/2015 4:06:05 PM, PPETKOVIC PRINTED: 10/15/2015 4:06:10 PM, C4004, PPETKOVIC

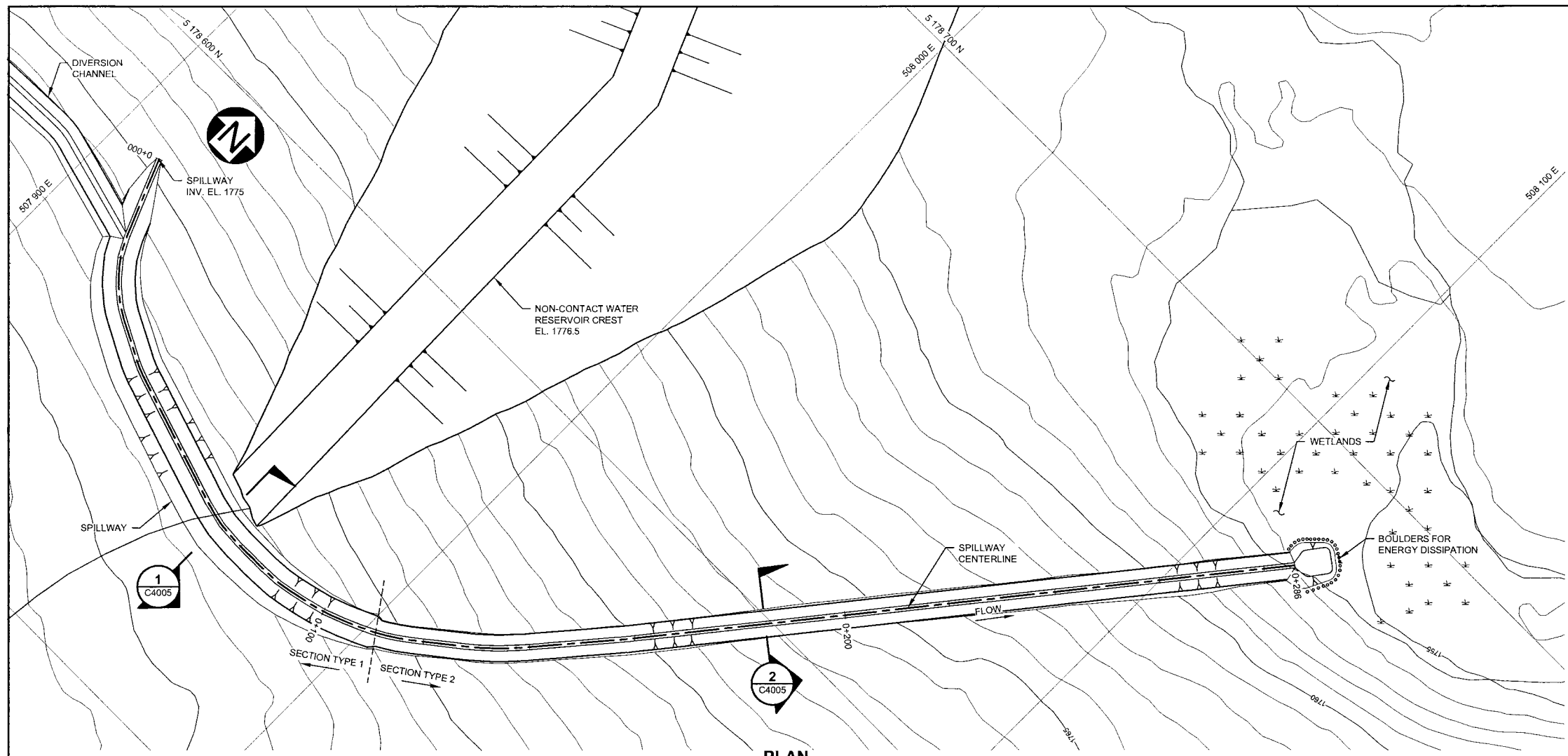

PLAN
SCALE A

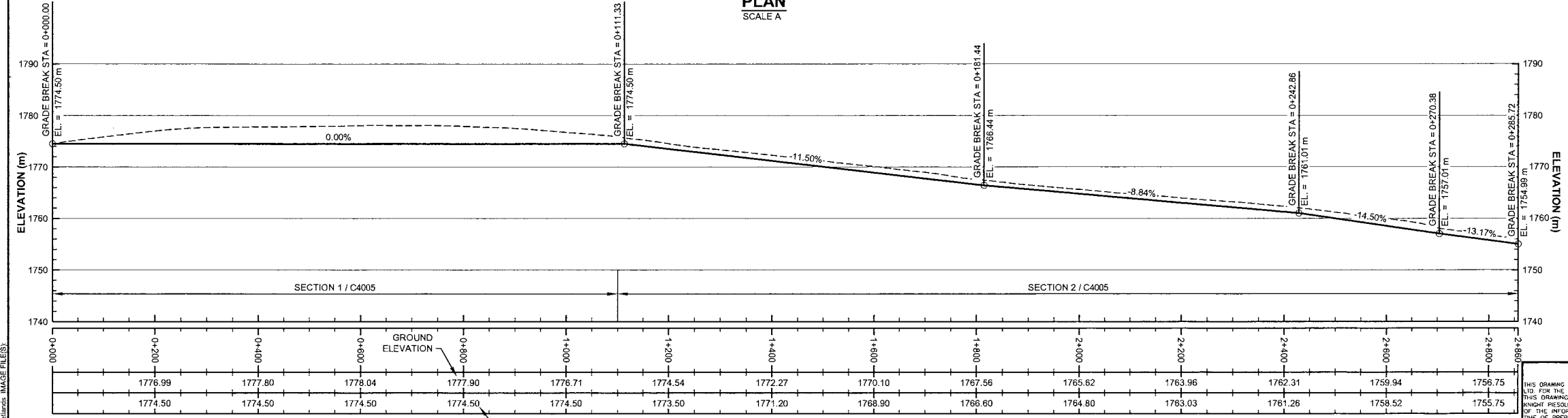

1 PROFILE
ALONG SPILLWAY
SCALE A

- NOTES:**
- COORDINATE GRID IS UTM NAD83 ZONE 12.
 - CONTOUR INTERVAL IS 1 METER.
 - DIMENSIONS AND ELEVATIONS ARE IN METERS, UNLESS NOTED OTHERWISE.

FOR INFORMATION ONLY

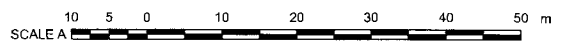

DISCLAIMER
THIS DRAWING WAS PREPARED BY KNIGHT PIESOLD LTD. FOR THE ACCOUNT OF THE CLIENT. THE MATERIAL ON IT REFLECTS KNIGHT PIESOLD'S BEST JUDGMENT IN THE LIGHT OF THE INFORMATION AVAILABLE TO IT AT THE TIME OF PREPARATION. ANY USE WHICH A THIRD PARTY MAKES OF THIS DRAWING, OR ANY RELIANCE ON OR DECISIONS TO BE MADE BASED ON IT, ARE THE RESPONSIBILITY OF SUCH THIRD PARTIES. KNIGHT PIESOLD ACCEPTS NO RESPONSIBILITY FOR DAMAGES, IF ANY, SUFFERED BY THE THIRD PARTY AS A RESULT OF DECISIONS MADE OR ACTIONS BASED ON THIS DRAWING. COPIES RESULTING FROM ELECTRONIC TRANSFER OR REPRODUCTION OF THIS DRAWING ARE UNCONTROLLED AND MAY NOT BE THE MOST RECENT REVISION OF THIS DRAWING.

Knight Piesold
CONSULTING

TINTINA RESOURCES INC.

BLACK BUTTE COPPER PROJECT

**NON-CONTACT WATER RESERVOIR
SPILLWAY CHANNEL
PLAN AND PROFILE**

DRG. NO.	DESCRIPTION	REV.	DATE
C4005	NON-CONTACT WATER RESERVOIR SPILLWAY SECTIONS		

DESIGNED	DRAWN	REVIEWED	APPROVED

REV.	DATE	DESCRIPTION	DESIGNED	DRAWN	REVIEWED	APPROVED
0	15OCT'15	ISSUED FOR MOP APPLICATION	MH	NSD	K.K.	K.K.

PIA NO.	DRAWING NO.	REVISION
VA101-460/3	C4004	0

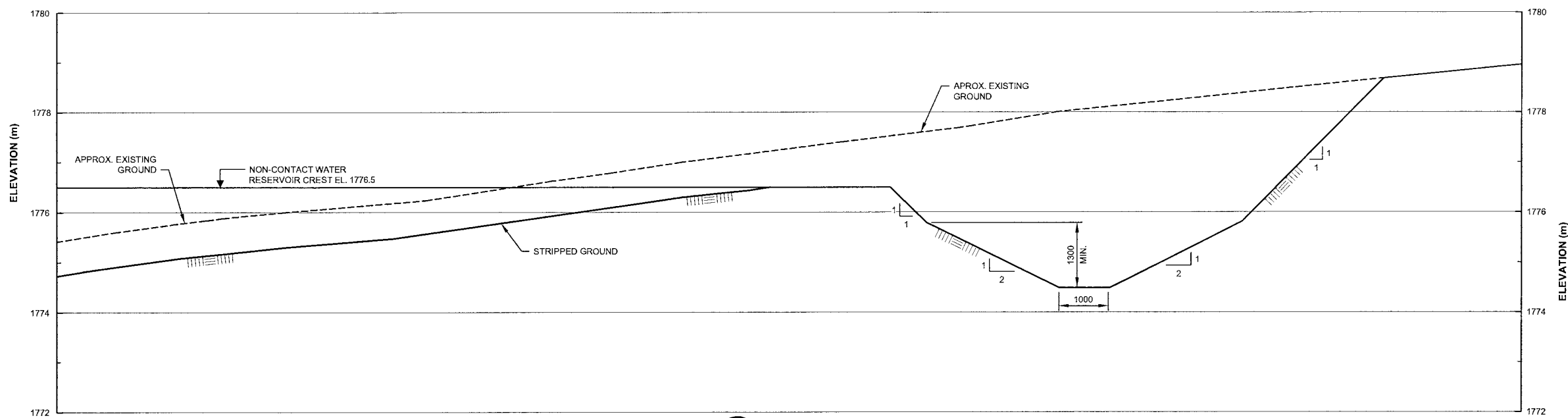

1
SECTION TYPE 1
TYPICAL SPILLWAY SECTION
SCALE A

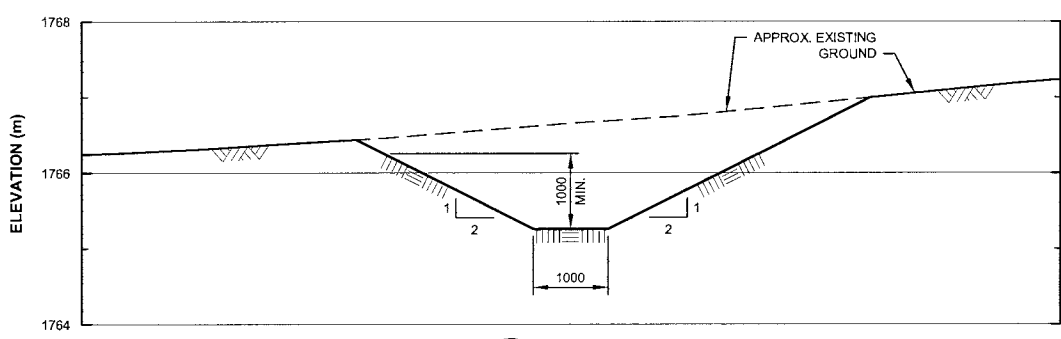

2
SECTION TYPE 2
TYPICAL SPILLWAY SECTION
SCALE A

- NOTES:**
1. DIMENSIONS ARE IN MILLIMETERS AND ELEVATIONS ARE IN METERS, UNLESS NOTED OTHERWISE.
 2. 1H : 1V CUT OR SHALLOWER CAN BE USED ABOVE SPILLWAY CHANNEL FLOW PATH.

FOR INFORMATION ONLY

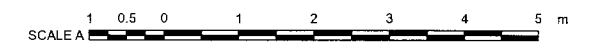

DISCLAIMER
THIS DRAWING WAS PREPARED BY KNIGHT PIESOLD LTD. FOR THE ACCOUNT OF THE CLIENT LISTED ON THIS DRAWING. THE MATERIAL ON IT REFLECTS KNIGHT PIESOLD'S BEST JUDGMENT IN THE LIGHT OF THE INFORMATION AVAILABLE TO IT AT THE TIME OF PREPARATION. ANY USE WHICH A THIRD PARTY MAKES OF THIS DRAWING, OR ANY RELIANCE ON OR DECISIONS TO BE MADE BASED ON IT, ARE THE RESPONSIBILITY OF SUCH THIRD PARTIES. KNIGHT PIESOLD ACCEPTS NO RESPONSIBILITY FOR DAMAGES, IF ANY, SUFFERED BY THE THIRD PARTY AS A RESULT OF DECISIONS MADE OR ACTIONS BASED ON THIS DRAWING. COPIES RESULTING FROM ELECTRONIC TRANSFER OR REPRODUCTION OF THIS DRAWING ARE UNCONTROLLED AND MAY NOT BE THE MOST RECENT REVISION OF THIS DRAWING.

Knight Piesold
CONSULTING

TINTINA RESOURCES INC.

BLACK BUTTE COPPER PROJECT

**NON-CONTACT WATER RESERVOIR
SPILLWAY
SECTIONS**

SAVED: M:\10100460\03\A\Acad\DWGS\C4005\C4005.dwg, 10/15/2015 4:02:52 PM, PPETKOVIC PRINTED: 10/15/2015 4:02:57 PM, C4005, PPETKOVIC

C4004	NON-CONTACT WATER RESERVOIR SPILLWAY CHANNEL PLAN AND PROFILE					
DRG. NO.	DESCRIPTION					
REV	DATE	DESCRIPTION	DESIGNED	DRAWN	REVIEWED	APPROVED
REFERENCE DRAWINGS		REVISIONS				

0	15OCT15	ISSUED FOR MOP APPLICATION	MH	NSD	K.	K.
REV	DATE	DESCRIPTION	DESIGNED	DRAWN	REVIEWED	APPROVED
REVISIONS		REVISIONS				

P/A NO.	DRAWING NO.	REVISION
VA101-460/3	C4005	0

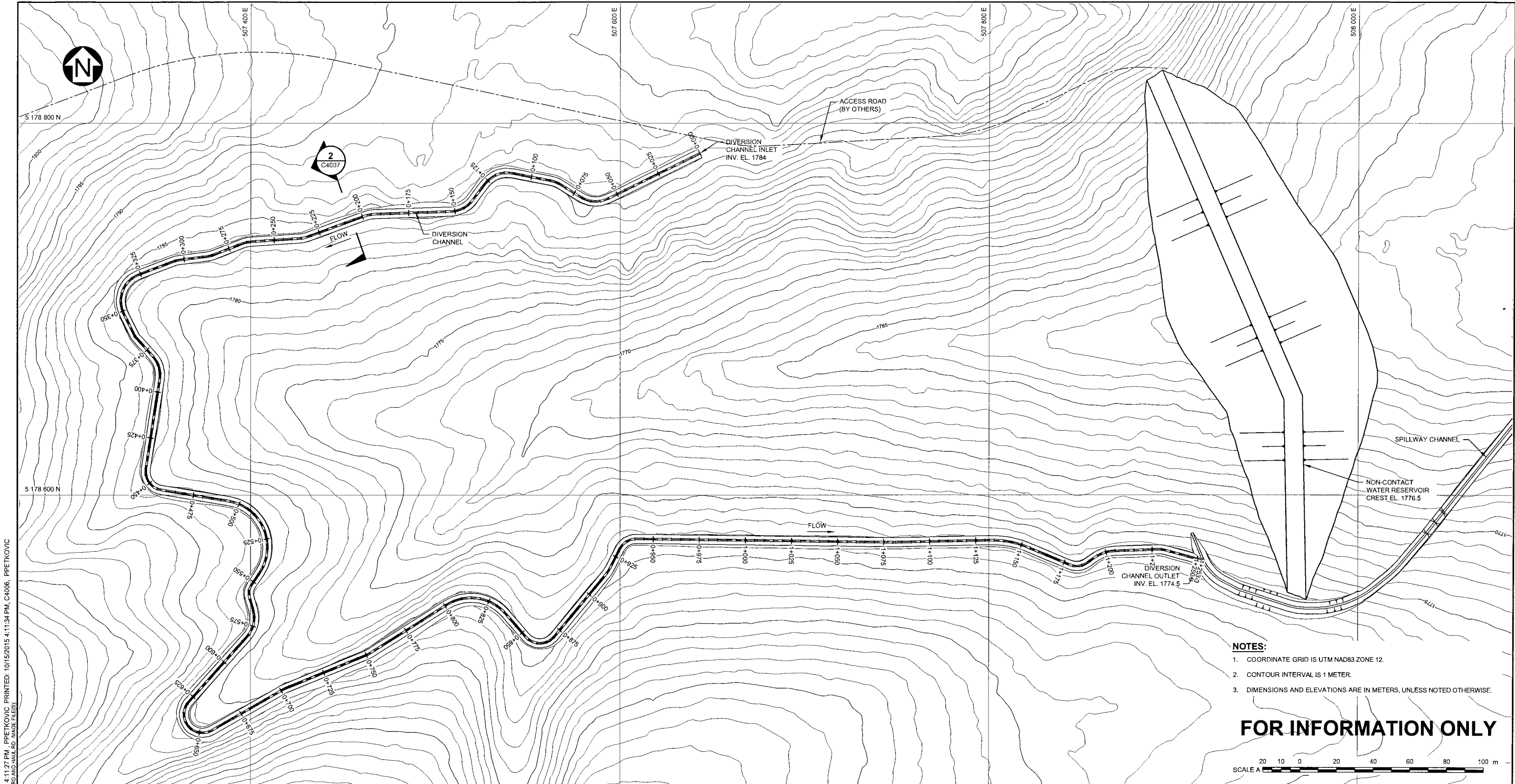

- NOTES:**
1. COORDINATE GRID IS UTM NAD83 ZONE 12.
 2. CONTOUR INTERVAL IS 1 METER.
 3. DIMENSIONS AND ELEVATIONS ARE IN METERS, UNLESS NOTED OTHERWISE.

FOR INFORMATION ONLY

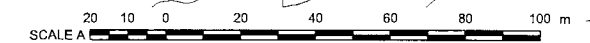

DISCLAIMER
 THIS DRAWING WAS PREPARED BY KNIGHT PIESOLD LTD. FOR THE ACCOUNT OF THE CLIENT LISTED ON THIS DRAWING. THE MATERIAL ON IT REFLECTS KNIGHT PIESOLD'S BEST JUDGEMENT IN THE LIGHT OF THE INFORMATION AVAILABLE TO IT AT THE TIME OF PREPARATION. ANY USE WHICH A THIRD PARTY MAKES OF THIS DRAWING OR ANY RELIANCE ON OR DECISIONS TO BE MADE BASED ON IT, ARE THE RESPONSIBILITY OF SUCH THIRD PARTY. KNIGHT PIESOLD ACCEPTS NO RESPONSIBILITY FOR DAMAGES, IF ANY, SUFFERED BY THE THIRD PARTY AS A RESULT OF DECISIONS MADE OR ACTIONS BASED ON THIS DRAWING. COPIES RESULTING FROM ELECTRONIC TRANSFER OR REPRODUCTION OF THIS DRAWING ARE UNCONTROLLED AND MAY NOT BE THE MOST RECENT REVISION OF THIS DRAWING.

<i>Knicht Piésold</i> CONSULTING		
TINTINA RESOURCES INC.		
BLACK BUTTE COPPER PROJECT		
NON-CONTACT WATER RESERVOIR DIVERSION CHANNEL PLAN		
PIA NO.	DRAWING NO.	REVISION
VA101-460/3	C4006	0

C4007 NON-CONTACT WATER RESERVOIR DIVERSION DITCH PROFILE & SECTION
 0 15OCT'15 ISSUED FOR MOP APPLICATION
 MH NSD
 10/15/2015 4:11:27 PM PPETKOVIC PRINTED: 10/15/2015 4:11:34 PM C4006 PPETKOVIC
 SAVE: M:\1010046003\A\cad\DWG\C4006\C4006.dwg
 PLOT: M:\1010046003\A\cad\DWG\C4006\C4006.dwg

DRG. NO.	DESCRIPTION	REV.	DATE	DESIGNED	DRAWN	REVIEWED	APPROVED
C4007	NON-CONTACT WATER RESERVOIR DIVERSION DITCH PROFILE & SECTION	0	15OCT'15				

REV.	DATE	DESCRIPTION	DESIGNED	DRAWN	REVIEWED	APPROVED
0	15OCT'15	ISSUED FOR MOP APPLICATION				

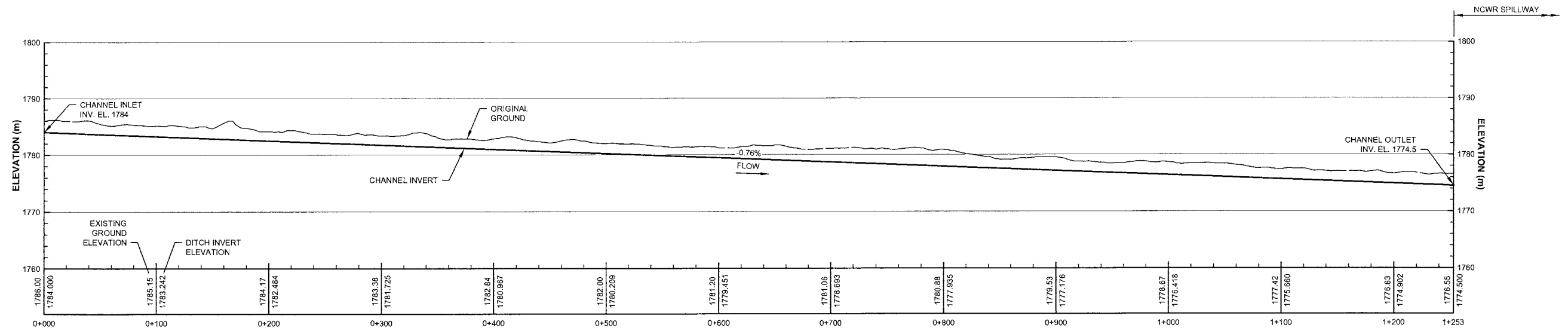

1 PROFILE
 C4006 **ALONG CHANNEL CENTERLINE**
 HORIZONTAL: SCALE A
 VERTICAL: SCALE B

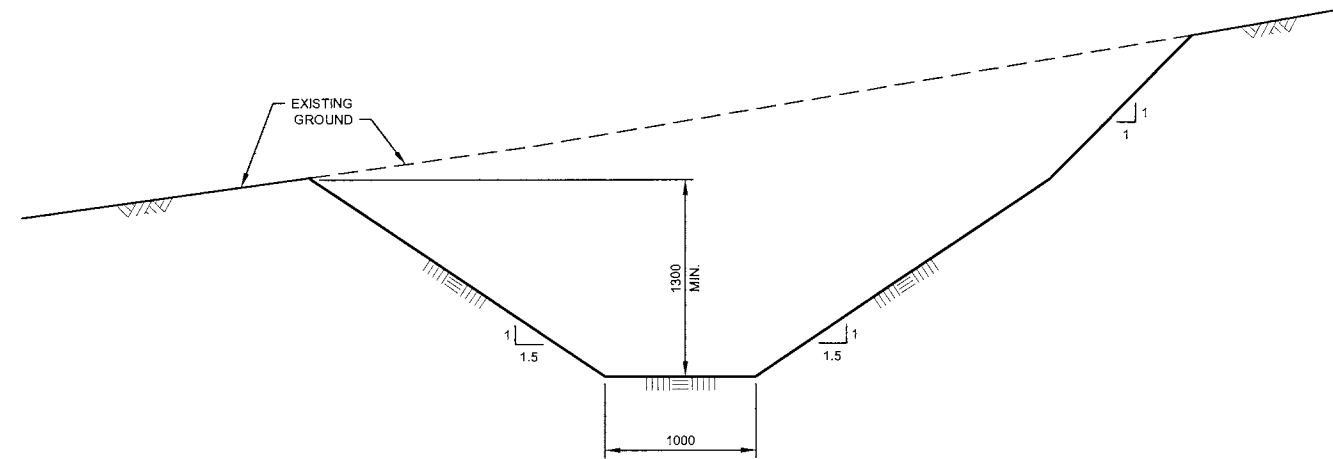

2 SECTION
 C4006 SCALE C

NOTES:

- DIMENSIONS ARE IN MILLIMETERS AND ELEVATIONS ARE IN METERS, UNLESS NOTED OTHERWISE.

FOR INFORMATION ONLY

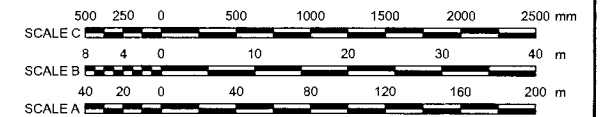

- DISCLAIMER -
 THIS DRAWING WAS PREPARED BY KNIGHT PIESOLD LTD. FOR THE ACCOUNT OF THE CLIENT LISTED ON THIS DRAWING. THE MATERIAL ON IT REFLECTS KNIGHT PIESOLD'S BEST JUDGEMENT IN THE LIGHT OF THE INFORMATION AVAILABLE TO IT AT THE TIME OF PREPARATION. ANY USE WHICH A THIRD PARTY MAKES OF THIS DRAWING OR ANY RELIANCE OR DECISIONS TO BE MADE BASED ON IT, ARE THE RESPONSIBILITY OF SUCH THIRD PARTIES. KNIGHT PIESOLD ACCEPTS NO RESPONSIBILITY FOR DAMAGES, IF ANY, SUFFERED BY THE THIRD PARTY AS A RESULT OF DECISIONS MADE OR ACTIONS BASED ON THIS DRAWING. COPIES RESULTING FROM ELECTRONIC TRANSFER OR REPRODUCTION OF THIS DRAWING ARE UNCONTROLLED AND MAY NOT BE THE MOST RECENT REVISION OF THIS DRAWING.

Knights Piésold
 CONSULTING

TINTINA RESOURCES INC.

BLACK BUTTE COPPER PROJECT

**NON-CONTACT WATER RESERVOIR
 DIVERSION CHANNEL
 PROFILE AND SECTION**

DRG. NO.	DESCRIPTION	REV	DATE	DESIGNED	DRAWN	REVIEWED	APPROVED
C4006	NON-CONTACT WATER RESERVOIR DIVERSION DITCH PLAN	0	15OCT15	MH	NSD	U.	U.
REFERENCE DRAWINGS				REVISIONS			
REVISIONS				REVISIONS			

PIA NO.	DRAWING NO.	REVISION
VA101-460/3	C4007	0

C:\Users\p.petrovic\Documents\Projects\VA101-460\Drawings\C5001\C5001.dwg
 PLOT DATE: 10/16/2015 10:31:03 AM
 PLOT BY: p.petrovic
 PLOT SCALE: 1:1
 PLOT SHEET: 1 OF 1
 PLOT AREA: 1100x1100
 PLOT DEVICE: HP DesignJet 5000 Series

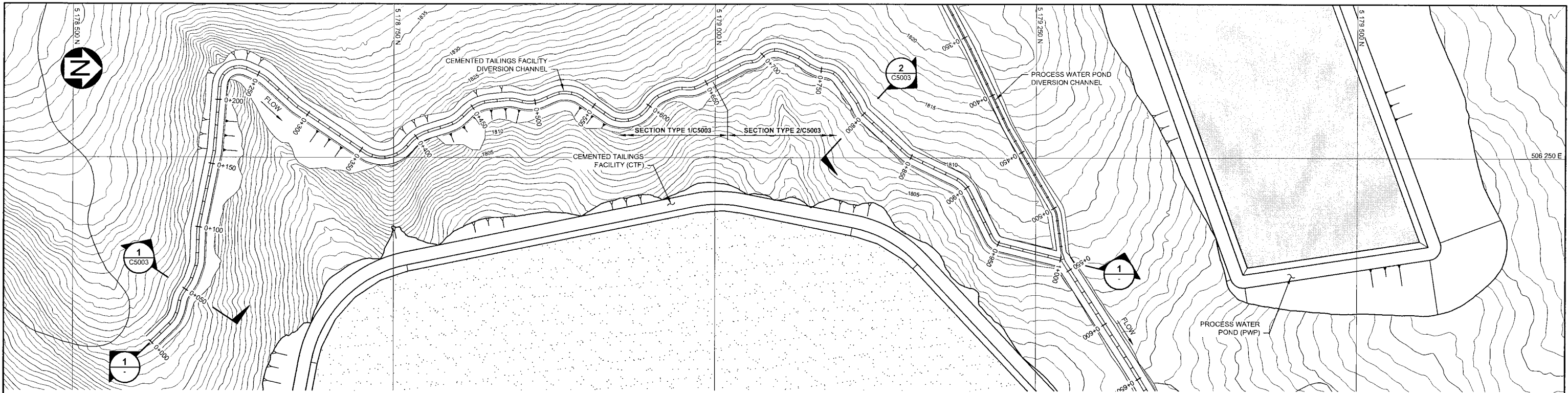

PLAN
CTF DIVERSION CHANNEL
SCALE A

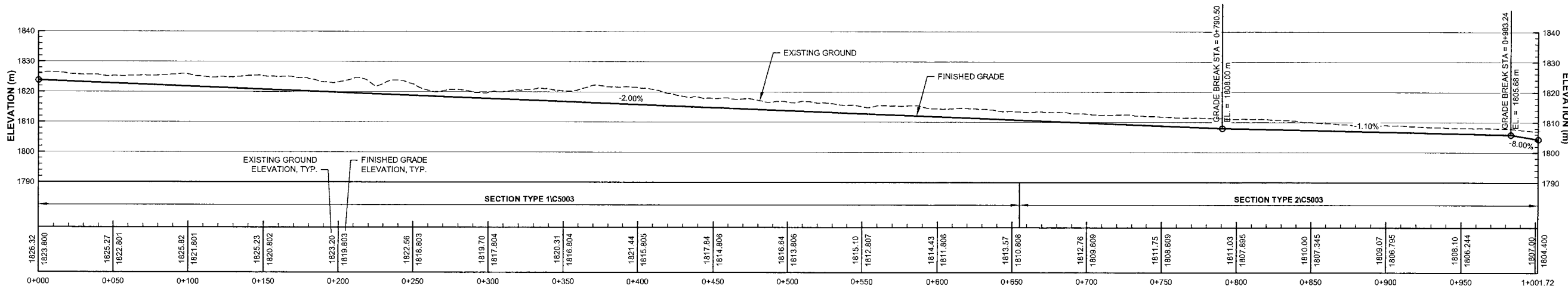

1 SECTION
PROFILE ALONG CHANNEL CENTERLINE
HORIZONTAL: SCALE A
VERTICAL: SCALE B

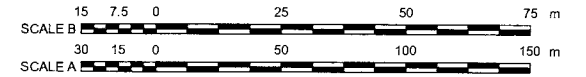

FOR INFORMATION ONLY

NOTES:

- COORDINATE GRID IS UTM NAD83 ZONE 12.
- CONTOUR INTERVAL IS 1 METER.
- DIMENSIONS AND ELEVATIONS ARE IN METERS, UNLESS NOTED OTHERWISE.

— DISCLAIMER —

THIS DRAWING WAS PREPARED BY KNIGHT PIESOLD LTD. FOR THE ACCOUNT OF THE CLIENT LISTED ON THIS DRAWING. THE MATERIAL ON IT REFLECTS KNIGHT PIESOLD'S BEST JUDGMENT IN THE LIGHT OF THE INFORMATION AVAILABLE TO IT AT THE TIME OF PREPARATION. ANY USE WHICH A THIRD PARTY MAKES OF THIS DRAWING, OR ANY RELIANCE ON OR DECISIONS TO BE MADE BASED ON IT, ARE THE RESPONSIBILITY OF SUCH THIRD PARTY. KNIGHT PIESOLD ACCEPTS NO RESPONSIBILITY FOR DAMAGES, IF ANY, SUFFERED BY THE THIRD PARTY AS A RESULT OF DECISIONS MADE OR ACTIONS BASED ON THIS DRAWING. COPIES RESULTING FROM ELECTRONIC TRANSFER OR REPRODUCTION OF THIS DRAWING ARE UNCONTROLLED AND MAY NOT BE THE MOST RECENT REVISION OF THIS DRAWING.

Knicht Piésold
CONSULTING

TINTINA RESOURCES INC.

BLACK BUTTE COPPER PROJECT

**CEMENTED TAILINGS FACILITY
DIVERSION CHANNEL
PLAN AND PROFILE**

P/A NO. VA101-460/3	DRAWING NO. C5001	REVISION 0	
-------------------------------	-----------------------------	----------------------	--

C5003	DIVERSION CHANNEL - TYPICAL SECTIONS	REV	DATE	DESCRIPTION	DESIGNED	DRAWN	REVIEWED	APPROVED

0	15OCT15	ISSUED FOR MOP APPLICATION	MH	NSD

SAVED: M:\1100460\09\VA101460\DWG\C5002\C5002.dwg, 10/16/2015 10:32:27 AM, PPRETKOVIC
 XREF FILES: Hydr. Baseline, Topo, Inv. Vert. Baseline, C5002, PWP, CTF, S2, IMAGE FILES

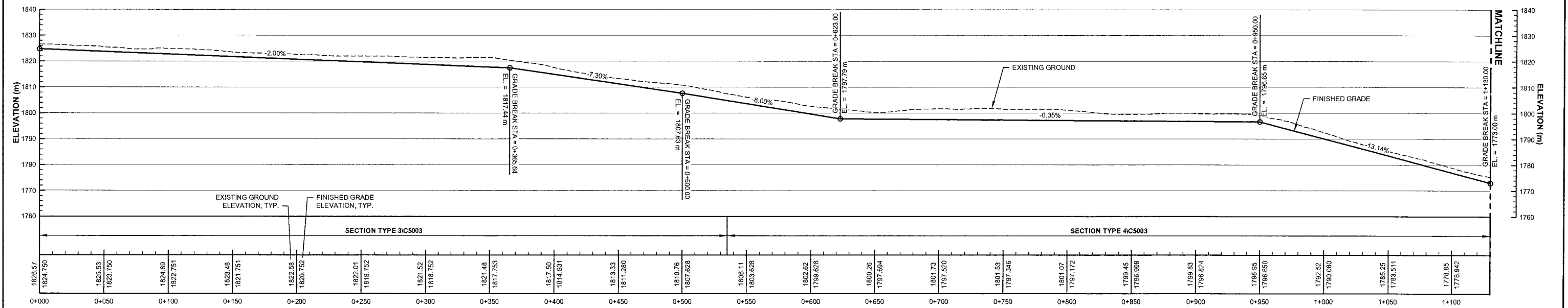
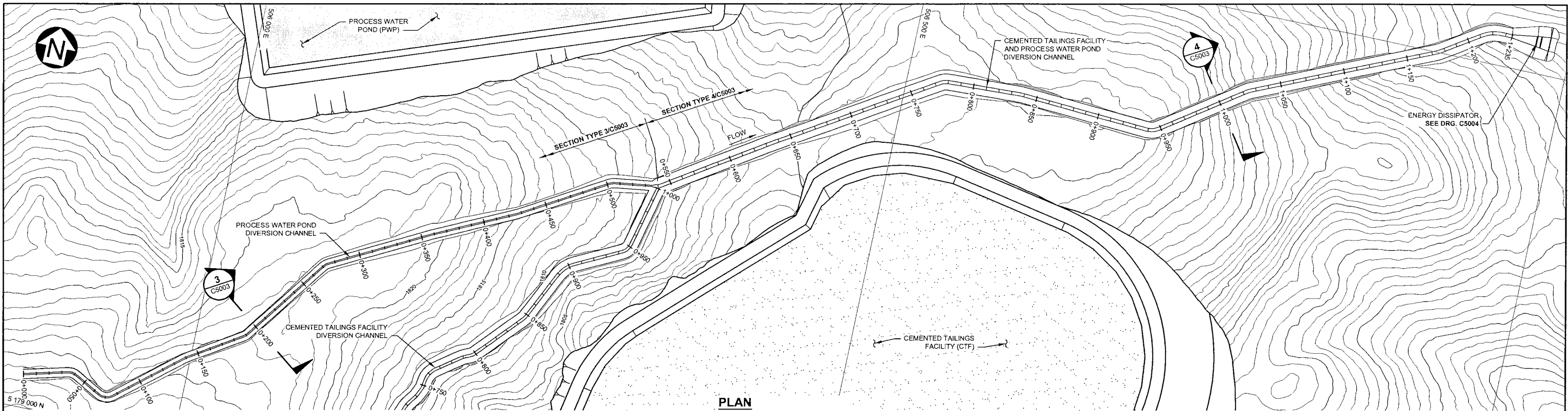

FOR INFORMATION ONLY

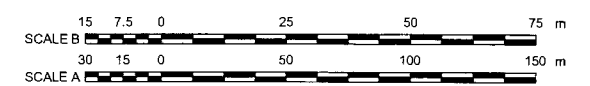

- NOTES:**
- COORDINATE GRID IS UTM NAD83 ZONE 12.
 - PLAN / SECTION BASED ON INFORMATION PROVIDED BY TINTINA RESOURCES INC., DATED FEB 03, 2011.
 - CONTOUR INTERVAL IS 1 METER.
 - DIMENSIONS AND ELEVATIONS ARE IN METERS, UNLESS NOTED OTHERWISE.

— DISCLAIMER —
 THIS DRAWING WAS PREPARED BY KNIGHT PIESOLD LTD. FOR THE ACCOUNT OF THE CLIENT LISTED ON THIS DRAWING. THE MATERIAL ON IT REFLECTS KNIGHT PIESOLD'S BEST JUDGMENT IN THE LIGHT OF THE INFORMATION AVAILABLE TO IT AT THE TIME OF PREPARATION. ANY USE WHICH A THIRD PARTY MAKES OF THIS DRAWING OR ANY RELIANCE ON OR DECISIONS TO BE MADE BASED ON IT ARE THE RESPONSIBILITY OF SUCH THIRD PARTIES. KNIGHT PIESOLD ACCEPTS NO RESPONSIBILITY FOR DAMAGES, IF ANY, SUFFERED BY THE THIRD PARTY AS A RESULT OF DECISIONS MADE OR ACTIONS BASED ON THIS DRAWING. COPIES RESULTING FROM ELECTRONIC TRANSFER OR REPRODUCTION OF THIS DRAWING ARE UNCONTROLLED AND MAY NOT BE THE MOST RECENT REVISION OF THIS DRAWING.

Knicht Piésold CONSULTING

TINTINA RESOURCES INC.

BLACK BUTTE COPPER PROJECT

PROCESS WATER POND DIVERSION CHANNEL PLAN AND PROFILE

PIA NO.	DRAWING NO.	REVISION
VA101-460/3	C5002	0

C5004	DIVERSION CHANNEL - ENERGY DISSIPATOR - PLAN AND DETAILS
C5003	DIVERSION CHANNEL - TYPICAL SECTIONS
DRG. NO.	DESCRIPTION
REFERENCE DRAWINGS	

REV	DATE	DESCRIPTION	DESIGNED	DRAWN	REVIEWED	APPROVED
REVISIONS						

0	15OCT15	ISSUED FOR MOP APPLICATION	JSL	NSD	<i>U. K.</i>	
REV	DATE	DESCRIPTION	DESIGNED	DRAWN	REVIEWED	APPROVED
REVISIONS						

SAVE: M:\1014603\AA\cadd\DWGS\C5003\C5003.dwg, 10/16/2015 10:33:22 AM, PPETKOVIC, 10/16/2015 10:33:25 AM, PPETKOVIC
 XREF FILES: (NONE)

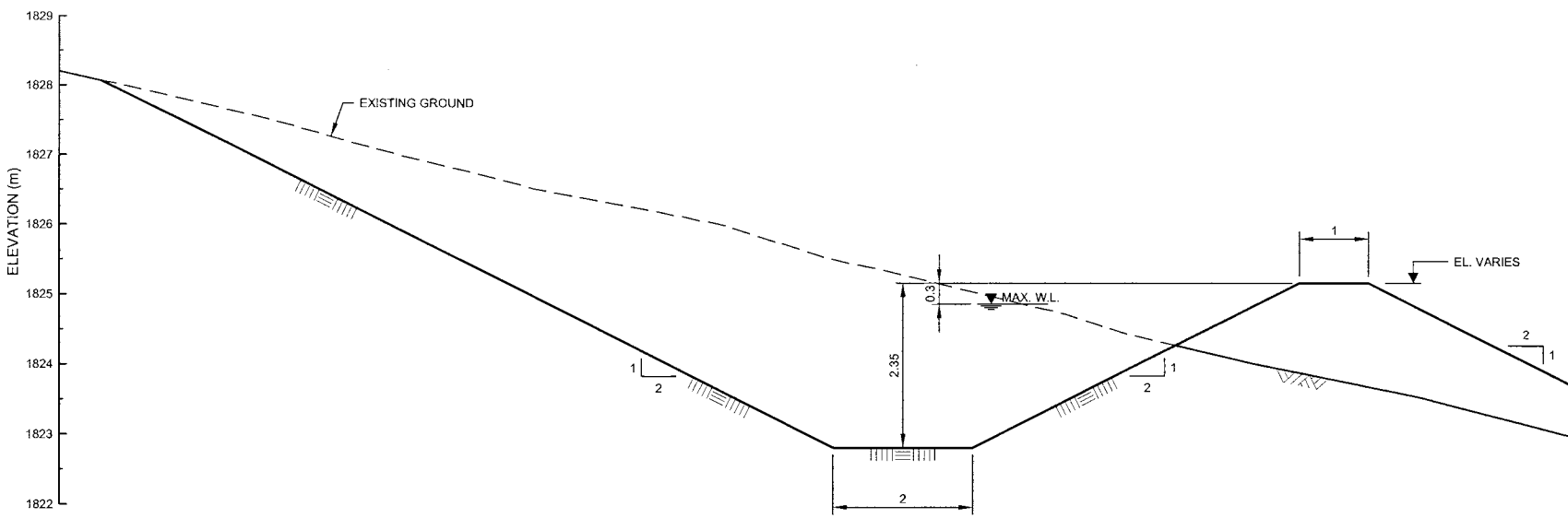

1 SECTION TYPE 1
 C5001 CTF DIVERSION CHANNEL (CUT AND FILL)
 SCALE A

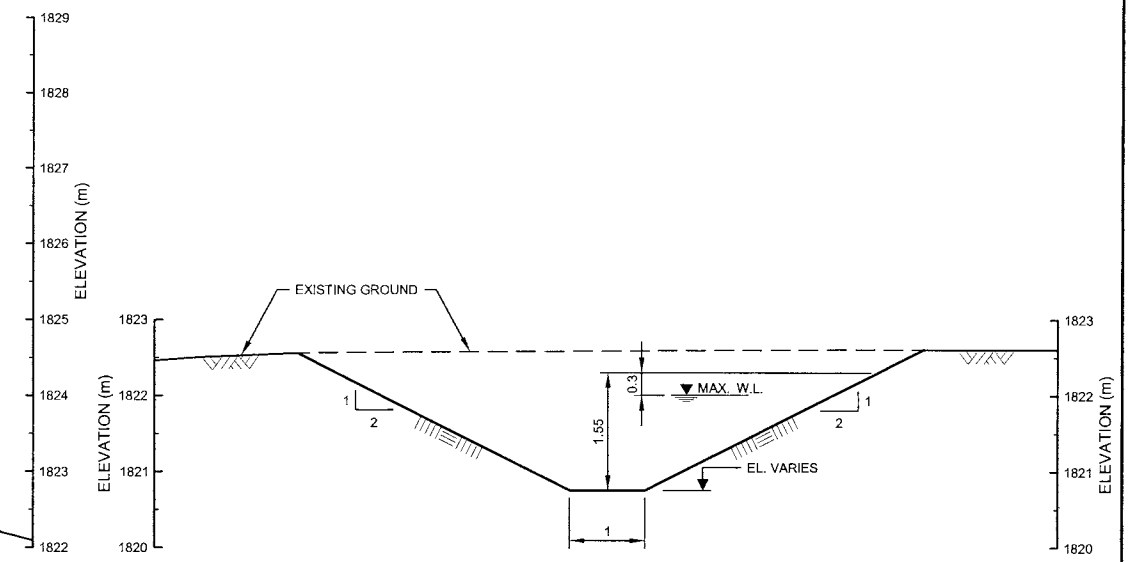

3 SECTION TYPE 3
 C5002 PWP DIVERSION CHANNEL
 SCALE A

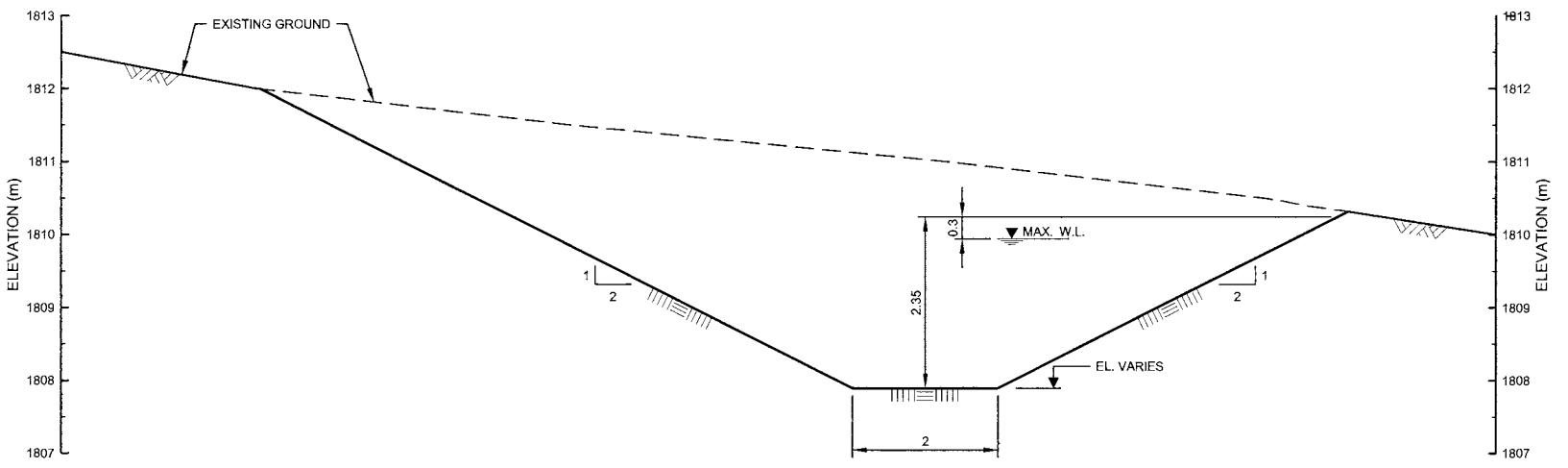

2 SECTION TYPE 2
 C5001 CTF DIVERSION CHANNEL (ALL CUT)
 SCALE A

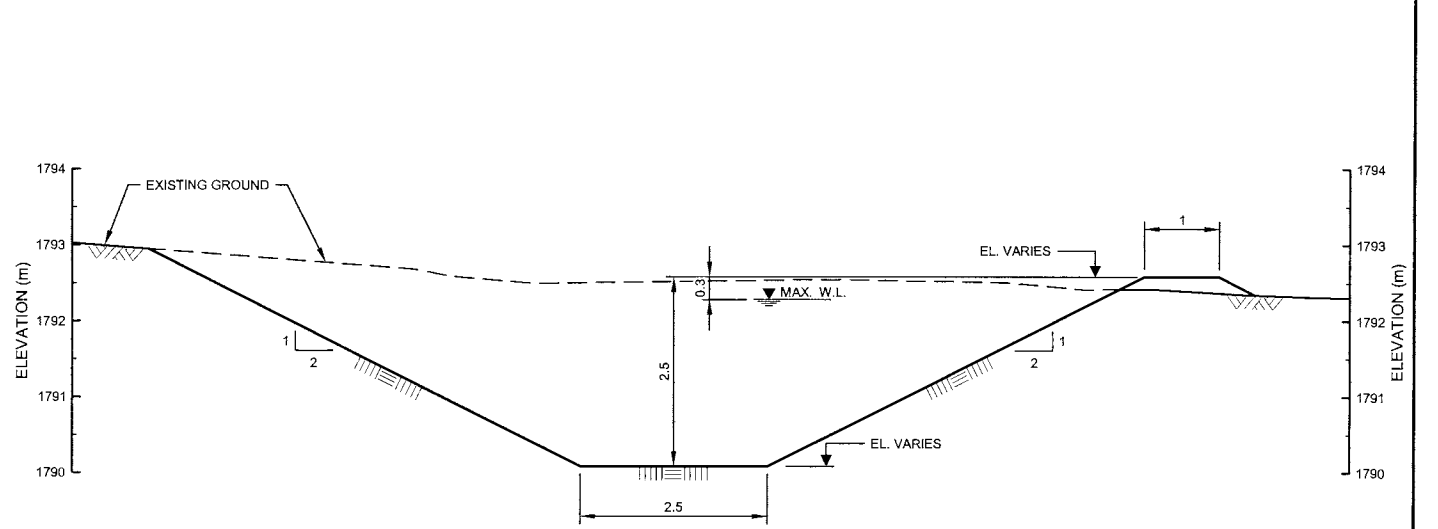

4 SECTION TYPE 4
 C5002 CTF AND PWP DIVERSION CHANNEL
 SCALE A

FOR INFORMATION ONLY

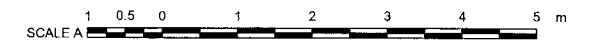

NOTES:

- DIMENSIONS AND ELEVATIONS ARE IN METERS, UNLESS NOTED OTHERWISE.
- MAXIMUM WATER LEVEL (MAX. W.L.) BASED ON ANTICIPATED WATER DEPTH DURING THE PROBABLE MAXIMUM FLOOD (PMF).

- DISCLAIMER - <small>THIS DRAWING WAS PREPARED BY KNIGHT PIESOLD LTD. FOR THE ACCOUNT OF THE CLIENT LISTED ON THIS DRAWING. THE MATERIAL ON IT REFLECTS KNIGHT PIESOLD'S BEST JUDGMENT IN THE LIGHT OF THE INFORMATION AVAILABLE TO IT AT THE TIME OF PREPARATION. ANY USE WHICH A THIRD PARTY MAKES OF THIS DRAWING, OR ANY RELIANCE ON OR DECISIONS TO BE MADE BASED ON IT, ARE THE RESPONSIBILITY OF SUCH THIRD PARTIES. KNIGHT PIESOLD ACCEPTS NO RESPONSIBILITY FOR DAMAGES, IF ANY, SUFFERED BY THE THIRD PARTY AS A RESULT OF DECISIONS MADE OR ACTIONS BASED ON THIS DRAWING. COPIES RESULTING FROM ELECTRONIC TRANSFER OR REPRODUCTION OF THIS DRAWING ARE UNCONTROLLED AND MAY NOT BE THE MOST RECENT REVISION OF THIS DRAWING.</small>	
TINTINA RESOURCES INC.	
BLACK BUTTE COPPER PROJECT	
DIVERSION CHANNEL TYPICAL SECTIONS	
PIA NO.	REVISION
VA101-460/3	0

DRG. NO.	DESCRIPTION	REV	DATE	DESIGNED	DRAWN	REVIEWED	APPROVED
C5002	PWP DIVERSION CHANNEL - PLAN AND PROFILE						
C5001	CTF DIVERSION CHANNEL - PLAN AND PROFILE						
REFERENCE DRAWINGS				REVISIONS			
REV	DATE	DESCRIPTION	DESIGNED	DRAWN	REVIEWED	APPROVED	
0	15OCT'15	ISSUED FOR MOP APPLICATION	MH	NSD	<i>[Signature]</i>	<i>[Signature]</i>	
REVISIONS				REVISIONS			

SAV: M:\101\0046003\AA\cadd\DWGS\C5004\C5004.dwg, 10/16/2015 10:34:51 AM, PPETKOVIC PRINTED: 10/16/2015 10:34:54 AM, Layout1, PPETKOVIC
 PLOT FILE: D:\p1\p1.dwg, 10/16/2015 10:34:51 AM, PPETKOVIC

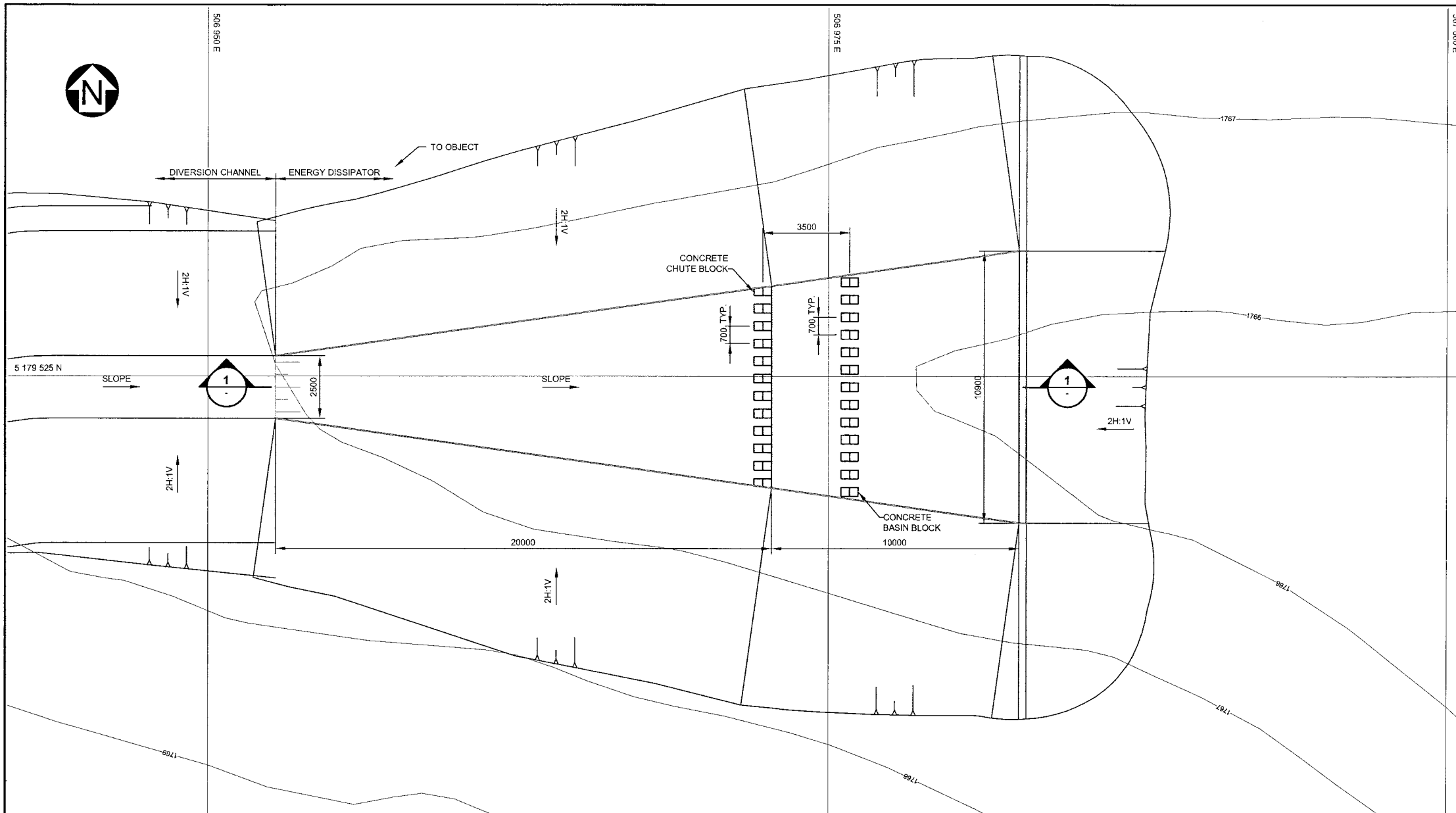

PLAN
ENERGY DISSIPATOR
SCALE A

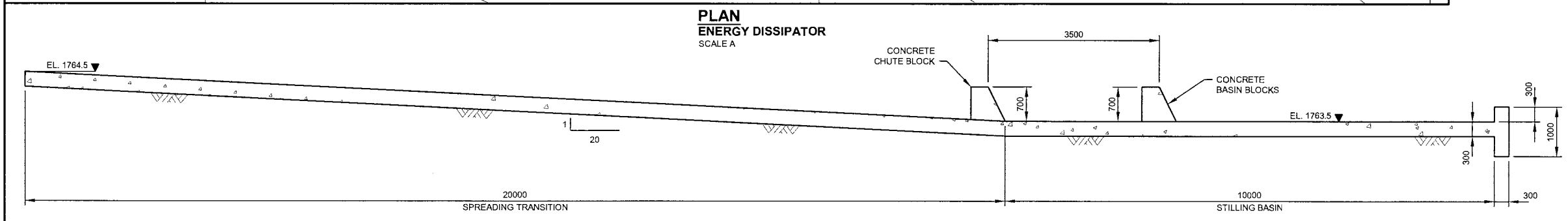

SECTION
SCALE B

LEGEND:
 CONCRETE

NOTES:
 1. DIMENSIONS ARE IN MILLIMETERS AND ELEVATIONS ARE IN METERS, UNLESS NOTED OTHERWISE.

FOR INFORMATION ONLY

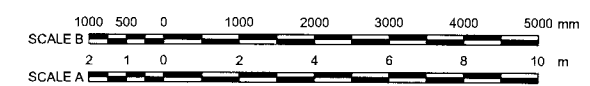

DISCLAIMER
 THIS DRAWING WAS PREPARED BY KNIGHT PIESOLD LTD. FOR THE ACCOUNT OF THE CLIENT LISTED ON THIS DRAWING. THE MATERIAL ON IT REFLECTS KNIGHT PIESOLD'S BEST JUDGEMENT IN THE LIGHT OF THE INFORMATION AVAILABLE TO IT AT THE TIME OF PREPARATION. ANY USE WHICH A THIRD PARTY MAKES OF THIS DRAWING, OR ANY RELIANCE ON OR DECISIONS TO BE MADE BASED ON IT, ARE THE RESPONSIBILITY OF SUCH THIRD PARTIES. KNIGHT PIESOLD ACCEPTS NO RESPONSIBILITY FOR DAMAGES, IF ANY, SUFFERED BY THE THIRD PARTY AS A RESULT OF DECISIONS MADE OR ACTIONS BASED ON THIS DRAWING. COPIES RESULTING FROM ELECTRONIC TRANSFER OR REPRODUCTION OF THIS DRAWING ARE UNCONTROLLED AND MAY NOT BE THE MOST RECENT REVISION OF THIS DRAWING.

Knight Piesold CONSULTING		
TINTINA RESOURCES INC.		
BLACK BUTTE COPPER PROJECT		
DIVERSION CHANNEL ENERGY DISSIPATOR PLAN AND DETAILS		
PIA NO.	DRAWING NO.	REVISION
VA101-460/3	C5004	0

DRG. NO.	DESCRIPTION
C5002	PWP DIVERSION CHANNEL - PLAN AND PROFILE
C5001	CTF DIVERSION CHANNEL - PLAN AND PROFILE

REV	DATE	DESCRIPTION	DESIGNED	DRAWN	REVIEWED	APPROVED
0	15OCT'15	ISSUED FOR MOP APPLICATION				

REV	DATE	DESCRIPTION	DESIGNED	DRAWN	REVIEWED	APPROVED

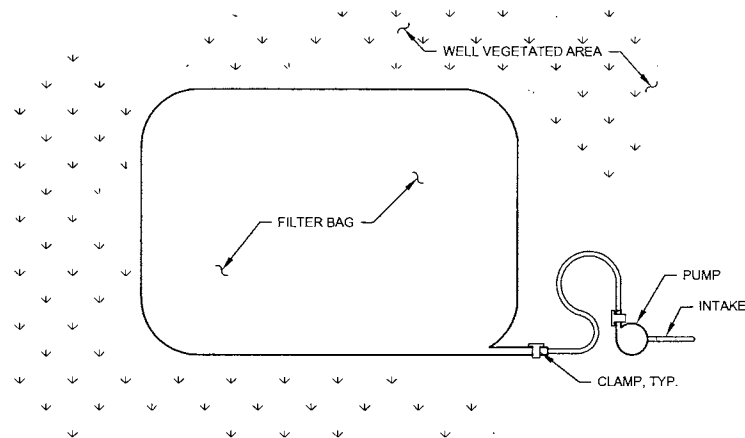

FB FILTER BAG PLAN
SCALE A

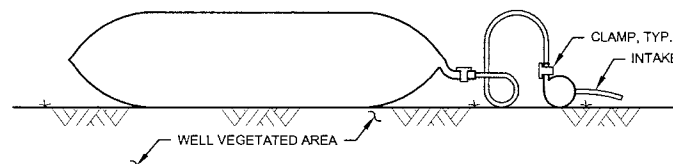

FB FILTER BAG ELEVATION
SCALE A

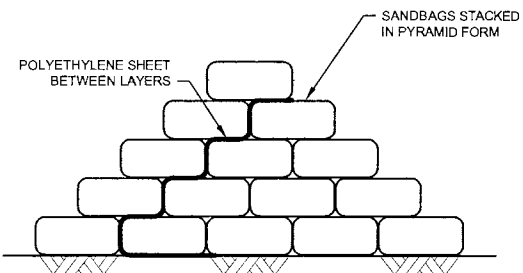

DS TEMPORARY STREAM DIVERSION STRUCTURE
NTS

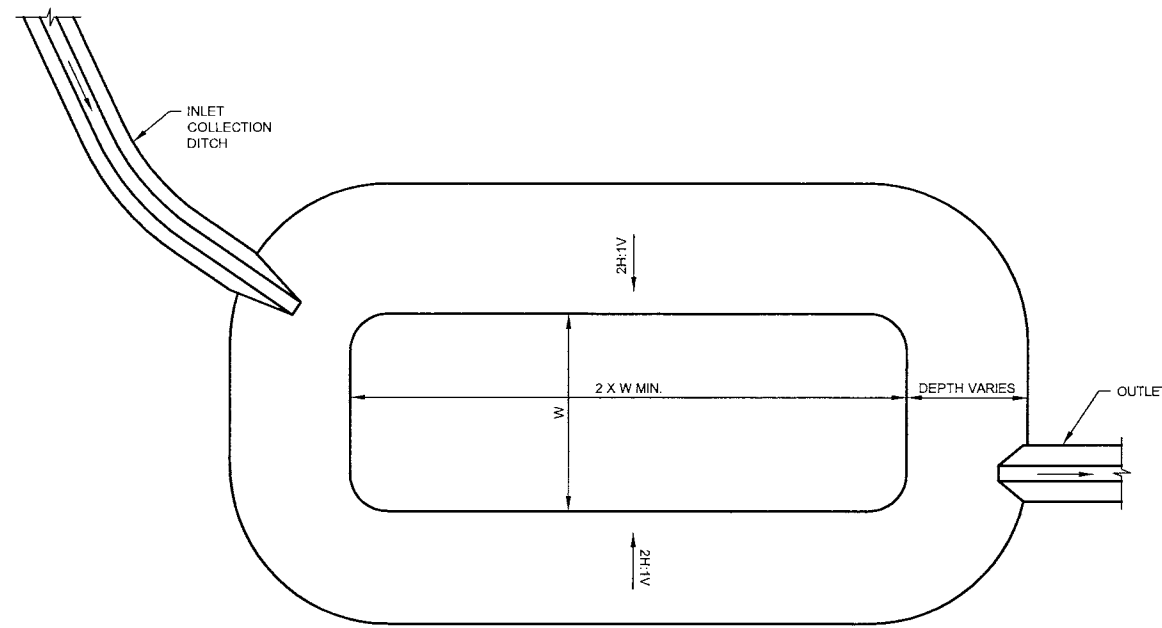

SB SEDIMENT BASIN PLAN
SCALE B

SEDIMENT BASIN GENERAL NOTES:

1. SEDIMENT BASINS DETAIN STORMWATER RUNOFF FROM A DISTURBED AREA FOR AN EXTENDED TIME, ALLOWING SEDIMENT TO SETTLE.
2. SEDIMENT BASINS MAY REMAIN IN PLACE DURING OPERATIONS, AS INDICATED IN THE PLANS OR AS DIRECTED BY THE ENGINEER, OR SITE EMT.
3. SEDIMENT BASINS MAY HAVE PUMP OR OUTLET CHANNEL TO COLLECTION DITCH.
4. RELEASES FROM SEDIMENT BASINS REQUIRE FURTHER WATER MANAGEMENT/BMPS (EX. PUMPBACK, DISCHARGE TO COLLECTION DITCHES, FILTER BAGS, AND VEGETATED BUFFER STRIPS.)
5. SEDIMENT BASINS TO BE FIELD FIT TO OPTIMIZE CUT AND FILL QUANTITIES TO ACHIEVE MINIMUM SPECIFIED DIMENSIONS.

SEDIMENT FILTER BAG GENERAL NOTES:

1. NON-WOVEN GEOTEXTILE FILTER BAG WHICH RETAINS ALL SEDIMENT PARTICLES LARGER THAN 150 MICRONS.
2. PLACE FILTER BAGS ON STABLE OR WELL VEGETATED AREAS WHICH ARE FLATTER THAN 5% AND WILL NOT ERODE WHEN SUBJECTED TO BAG DISCHARGE.
3. CLAMP PUMP DISCHARGE HOSE SECURELY INTO FILTER BAGS.
4. THE PUMPING RATE SHALL BE NO GREATER THAN 750 gpm OR 1/2 THE MAXIMUM SPECIFIED BY THE MANUFACTURER, WHICHEVER IS LESS. PUMP INTAKES SHOULD BE FLOATING AND SCREENED.
5. WHEN SEDIMENTS FILL 1/2 THE VOLUME OF A FILTER BAG, IMMEDIATELY REMOVE THAT BAG FROM SERVICE. PROPERLY DISPOSE OF SPENT BAGS WITH THEIR SEDIMENTS. SPARE BAGS SHALL BE KEPT AVAILABLE FOR REPLACEMENT OF THOSE THAT HAVE FILLED.
6. THE DISCHARGE FROM THE FILTER BAG SHOULD NOT PASS THROUGH A DISTURBED AREA OR CAUSE AN EROSION PROBLEM DOWN SLOPE.
7. VEGETATED BUFFER STRIP WILL BE LEFT DOWNSTREAM OF THE FILTER BAG.
8. FILTER BAGS SHALL BE INSPECTED DAILY. IF ANY PROBLEM IS DETECTED PUMPING SHALL CEASE AND NOT RESUME UNTIL THE PROBLEM IS CORRECTED.

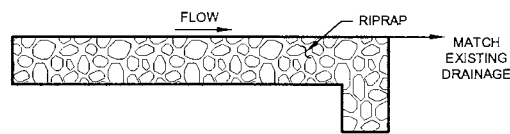

TYPE 1
SMALL DRAINAGES

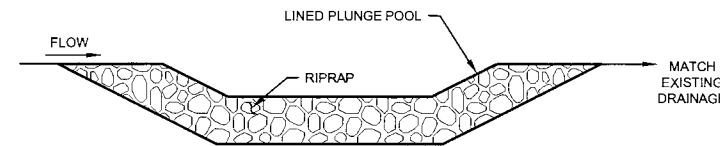

TYPE 2
LARGER DRAINAGES

ED ROCK ENERGY DISSIPATOR
NTS

FOR INFORMATION ONLY

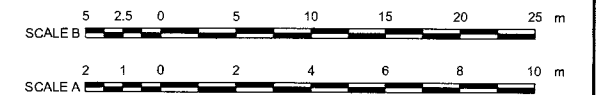

- DISCLAIMER -
THIS DRAWING WAS PREPARED BY KNIGHT PIESOLD LTD. FOR THE ACCOUNT OF THE CLIENT LISTED ON THIS DRAWING. THE MATERIAL ON IT REFLECTS KNIGHT PIESOLD'S BEST JUDGMENT IN THE LIGHT OF THE INFORMATION AVAILABLE TO IT AT THE TIME OF PREPARATION. ANY USE WHICH A THIRD PARTY MAKES OF THIS DRAWING, OR ANY RELIANCE ON OR DECISIONS TO BE MADE BASED ON IT, ARE THE RESPONSIBILITY OF SUCH THIRD PARTIES. KNIGHT PIESOLD ACCEPTS NO RESPONSIBILITY FOR DAMAGES, IF ANY, SUFFERED BY THE THIRD PARTY AS A RESULT OF DECISIONS MADE OR ACTIONS BASED ON THIS DRAWING. COPIES RESULTING FROM ELECTRONIC TRANSFER OR REPRODUCTION OF THIS DRAWING ARE UNCONTROLLED AND MAY NOT BE THE MOST RECENT REVISION OF THIS DRAWING.

Knights Piesold
CONSULTING

TINTINA RESOURCES INC.

BLACK BUTTE COPPER PROJECT

**EROSION CONTROL BMP
TYPICAL SECTIONS AND DETAILS
SHEET 2 OF 2**

PIA NO.	DRAWING NO.	REVISION
VA101-460/3	C5006	0

SAVED: M:\101\00460\03\VA101-460\DWG\C5006\C5006.dwg, 10/16/2015 10:36:43 AM, PPETKOVIC PRINTED: 10/16/2015 10:36:48 AM, C5006, PPETKOVIC XREF FILE(S): IMAGE FILE(S)

DRG. NO.	DESCRIPTION	REV	DATE	DESIGNED	DRAWN	REVIEWED	APPROVED
	REFERENCE DRAWINGS						
	REVISIONS						
	REVISIONS						

10/16/2015 7:28:50 AM, PPETKOVIC PRINTED: 10/16/2015 7:29:05 AM, C6100, PPETKOVIC
 S:\REF FILES\1101004603\VA101-4603\DWG\C6100-10162015 7:28:50 AM, PPETKOVIC PRINTED: 10/16/2015 7:29:05 AM, C6100, PPETKOVIC
 S:\REF FILES\1101004603\VA101-4603\DWG\C6100-10162015 7:28:50 AM, PPETKOVIC PRINTED: 10/16/2015 7:29:05 AM, C6100, PPETKOVIC
 S:\REF FILES\1101004603\VA101-4603\DWG\C6100-10162015 7:28:50 AM, PPETKOVIC PRINTED: 10/16/2015 7:29:05 AM, C6100, PPETKOVIC

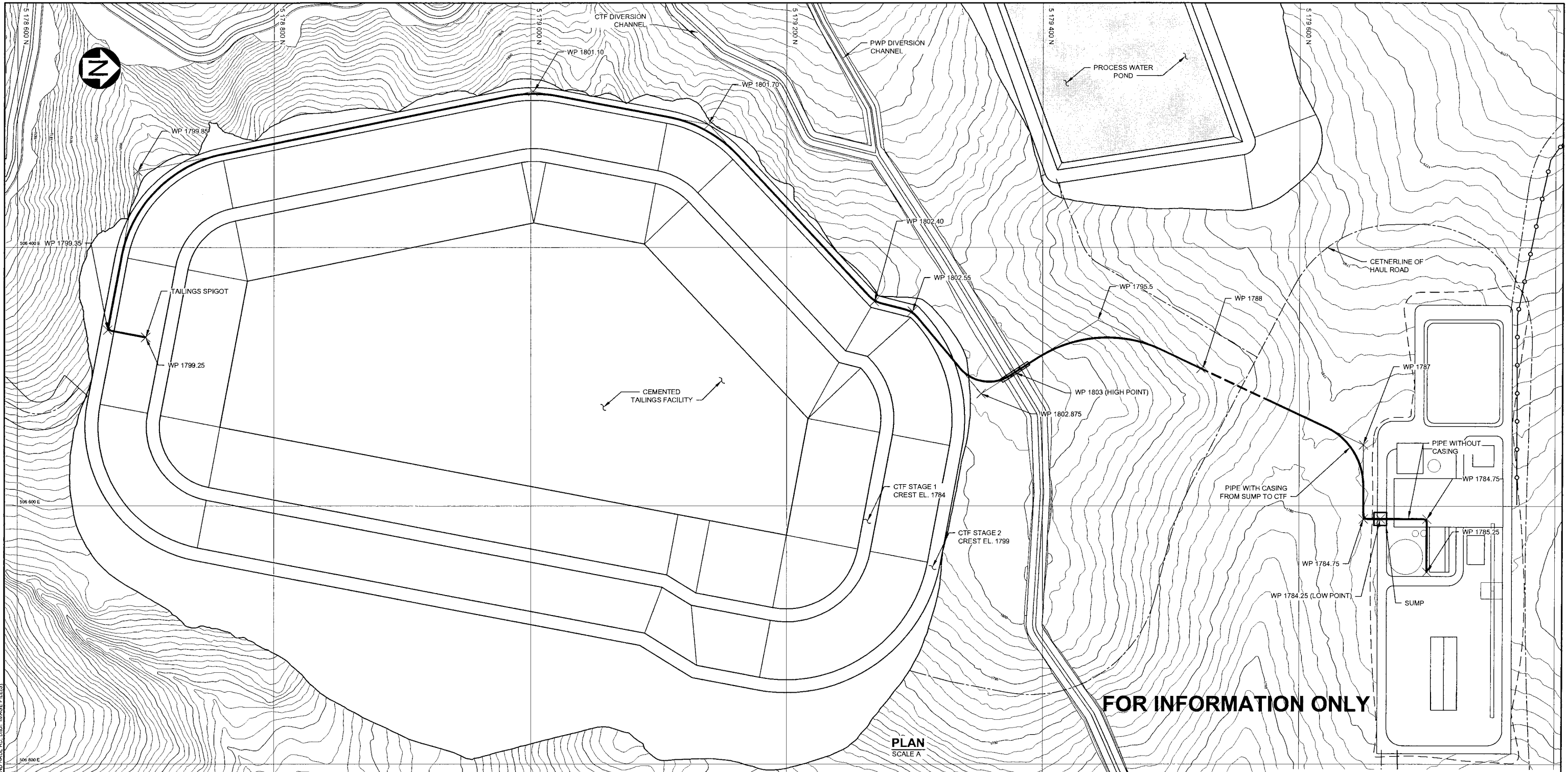

PLAN
SCALE A

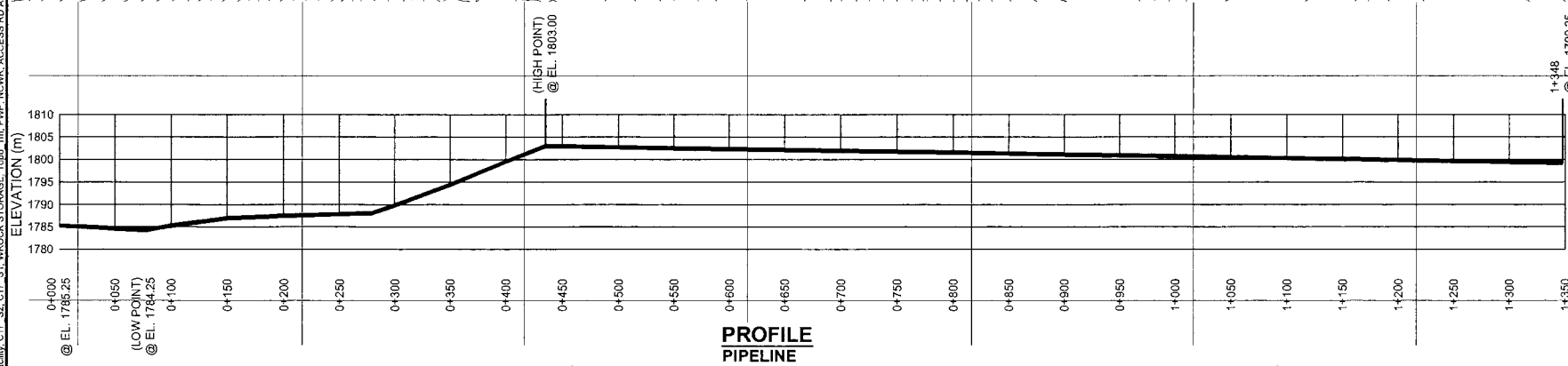

PROFILE
PIPELINE
SCALE B

- NOTES:**
- COORDINATE GRID IS UTM NAD83 ZONE 12.
 - PIPELINE LAYOUT BASED ON INFORMATION PROVIDED BY MG ENGINEERING, DATED (SEP 29, 2015).
 - CONTOUR INTERVAL IS 1 METER.
 - DIMENSIONS AND ELEVATIONS ARE IN METERS, UNLESS NOTED OTHERWISE.
 - TAILINGS DELIVERY SYSTEM DESIGNED BY MG ENGINEERING.
 - PIPELINE CONSTRUCTED USING 8" STEEL PN 150 PIPE.
 - PIPELINE INSULATED TO PROTECT FROM FREEZING.
 - TAILINGS PUMP TO BE DESIGNED BY TETRA TECH.



FOR INFORMATION ONLY

DISCLAIMER
 THIS DRAWING WAS PREPARED BY KNIGHT PIESOLD LTD. FOR THE ACCOUNT OF THE CLIENT LISTED ON THIS DRAWING. THE MATERIAL ON IT REFLECTS KNIGHT PIESOLD'S BEST JUDGEMENT IN THE LIGHT OF THE INFORMATION AVAILABLE TO IT AT THE TIME OF PREPARATION. ANY USE WHICH A THIRD PARTY MAKES OF THIS DRAWING OR ANY RELIANCE ON OR DECISIONS TO BE MADE BASED ON IT ARE THE RESPONSIBILITY OF SUCH THIRD PARTIES. KNIGHT PIESOLD ACCEPTS NO RESPONSIBILITY FOR DAMAGES, IF ANY, SUFFERED BY THE THIRD PARTY AS A RESULT OF DECISIONS MADE OR ACTIONS BASED ON THIS DRAWING. COPIES RESULTING FROM ELECTRONIC TRANSFER OR REPRODUCTION OF THIS DRAWING ARE UNCONTROLLED AND MAY NOT BE THE MOST RECENT REVISION OF THIS DRAWING.

Knicht Piesold
CONSULTING

TINTINA RESOURCES INC.

BLACK BUTTE COPPER PROJECT

TAILINGS DELIVERY SYSTEM PLAN

DRG. NO.	DESCRIPTION	REV	DATE	DESIGNED	DRAWN	REVIEWED	APPROVED

REV	DATE	DESCRIPTION	DESIGNED	DRAWN	REVIEWED	APPROVED
0	15OCT'15	ISSUED FOR MOP APPLICATION	GIM	PP	K.	K.

PIA NO.	DRAWING NO.	REVISION
VA101-460/3	C6100	0

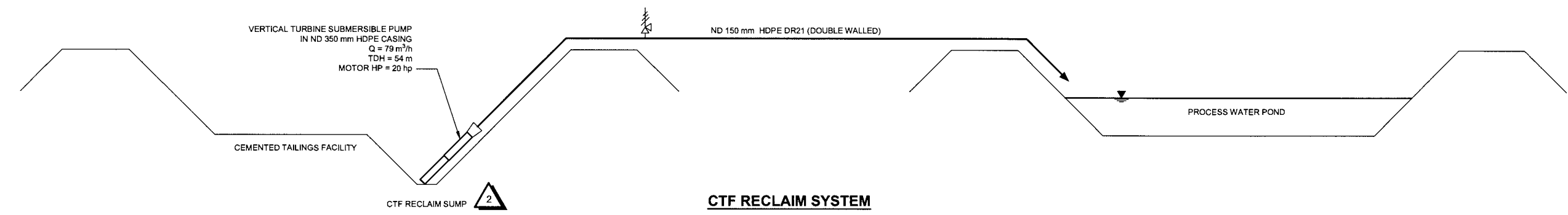
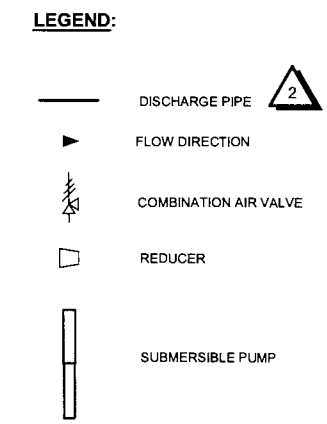

CTF RECLAIM SYSTEM

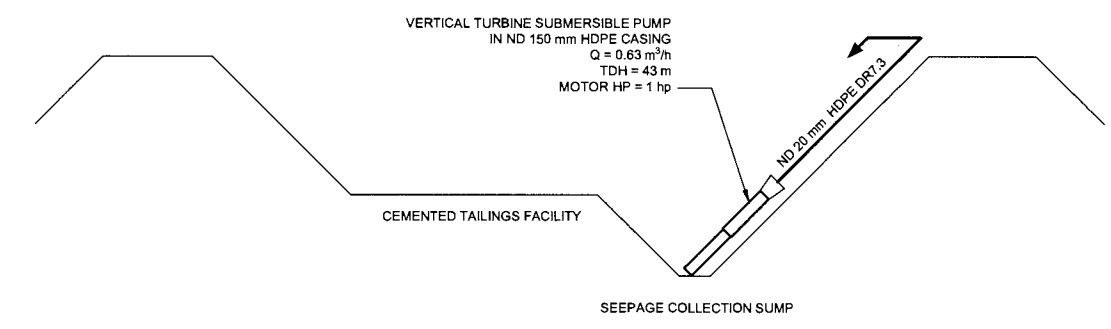

CTF SEEPAGE COLLECTION AND RECYCLE SYSTEM

FOR INFORMATION ONLY

- DISCLAIMER -

THIS DRAWING WAS PREPARED BY KNIGHT PIESOLD LTD. FOR THE ACCOUNT OF THE CLIENT LISTED ON THIS DRAWING. THE MATERIAL ON IT REFLECTS KNIGHT PIESOLD'S BEST JUDGEMENT IN THE LIGHT OF THE INFORMATION AVAILABLE TO IT AT THE TIME OF PREPARATION. ANY USE WHICH A THIRD PARTY MAKES OF THIS DRAWING OR ANY RELIANCE ON OR DECISIONS TO BE MADE BASED ON IT, ARE THE RESPONSIBILITY OF SUCH THIRD PARTIES. KNIGHT PIESOLD ACCEPTS NO RESPONSIBILITY FOR DAMAGES, IF ANY, SUFFERED BY THE THIRD PARTY AS A RESULT OF DECISIONS MADE OR ACTIONS BASED ON THIS DRAWING. COPIES RESULTING FROM ELECTRONIC TRANSFER OR REPRODUCTION OF THIS DRAWING ARE UNCONTROLLED AND MAY NOT BE THE MOST RECENT REVISION OF THIS DRAWING.

Knight Piesold
CONSULTING

TINTINA RESOURCES INC.

BLACK BUTTE COPPER PROJECT

**CEMENTED TAILINGS FACILITY
WATER MANAGEMENT SYSTEMS
PIPING AND INSTRUMENTATION DIAGRAM**

DRG. NO.	DESCRIPTION	REV	DATE	DESIGNED	DRAWN	REVIEWED	APPROVED
C6210	CEMENTED TAILINGS TO PROCESS WATER POND - PLAN AND PROFILE						

REV	DATE	DESCRIPTION	DESIGNED	DRAWN	REVIEWED	APPROVED
2	20APR'17	VERTICAL PUMP SPECIFICATION REVISED	GIM	RAF	<i>[Signature]</i>	<i>[Signature]</i>
1	29APR'16	VERTICAL PUMP SPECIFICATION REVISED	GIM	RAP	KJB	KJB
0	15OCT'15	ISSUED FOR MOP APPLICATION	JEF	KJM	KJB	KJB

PIA NO.	DRAWING NO.	REVISION
VA101-460/3	C6200	2

XREF FILES) . IMAGE FILES) .
 SAVED: M:\1010046003\VA101-460\DWGS\G6200\C6200_2_4212017 8:05:23 AM . REAHHAM PRINTED: 4/21/2017 8:25:06 AM. C6200 . REAHHAM

SAV: M:\1101046003\AA\ad\DWGS\C6210\C6210_2_4/27/2017 3:14:11 PM, WLAHODA PRINTED: 4/27/2017 3:23:51 PM, layout, WLAHODA XREF FILES, IMAGE FILES

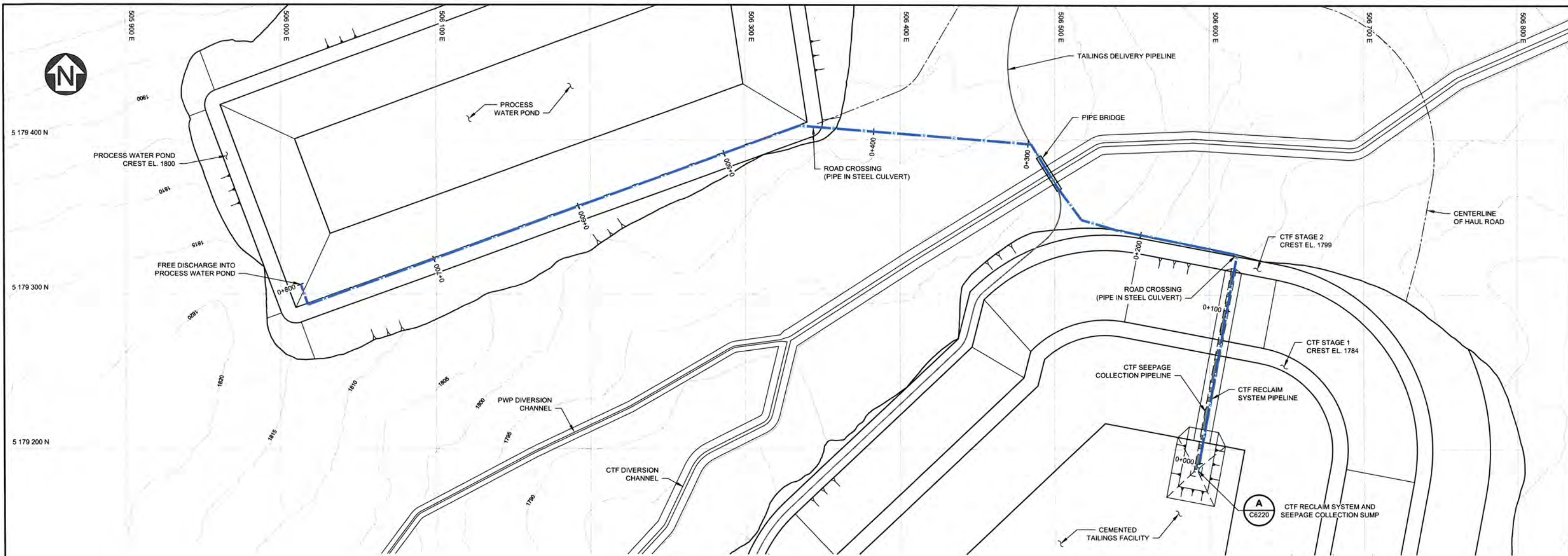

PLAN
SCALE A

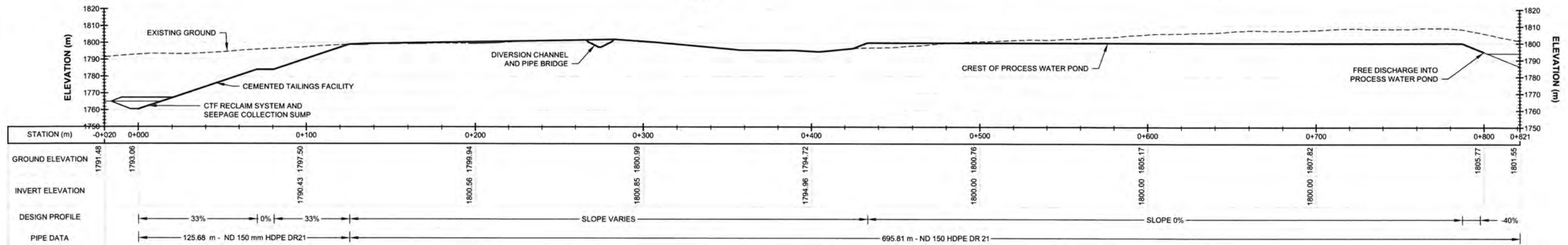

PROFILE
SCALE A

FOR INFORMATION ONLY

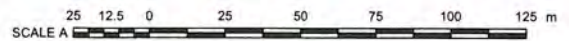

- NOTES:**
- COORDINATE GRID IS UTM NAD83 ZONE 12.
 - CONTOUR INTERVAL IS 1 METER.
 - DIMENSIONS AND ELEVATIONS ARE IN METERS, UNLESS NOTED OTHERWISE.

- LEGEND:**
- — — — — RECLAIM SYSTEM PIPELINE
 - - - - - SEEPAGE COLLECTION PIPELINE

DRG. NO.	DESCRIPTION
C6230	CTF - WATER MANAGEMENT SYSTEMS - TYPICAL SECTIONS (2 OF 2)
C6220	CTF - WATER MANAGEMENT SYSTEMS - TYPICAL SECTIONS (1 OF 2)
C6200	CEMENTED TAILINGS FACILITY - WATER MANAGEMENT SYSTEMS - P&ID

REV	DATE	DESCRIPTION	DESIGNED	DRAWN	REVIEWED	APPROVED

REV	DATE	DESCRIPTION	DESIGNED	DRAWN	REVIEWED	APPROVED
2	27APR'17	LABELS ADJUSTED	GIM	WAL	KDE	KDE
1	29APR'16	PIPE DATA REVISED	GIM	RAP	KDE	KDE
0	15OCT'15	ISSUED FOR MOP APPLICATION	JEF	KJM	KJB	KJB

<small>DISCLAIMER</small> THIS DRAWING WAS PREPARED BY KNIGHT PIESOLD LTD. FOR THE ACCOUNT OF THE CLIENT LISTED ON THIS DRAWING. THE MATERIAL ON IT REFLECTS KNIGHT PIESOLD'S BEST JUDGEMENT IN THE LIGHT OF THE INFORMATION AVAILABLE TO IT AT THE TIME OF PREPARATION. ANY USE WHICH A THIRD PARTY MAKES OF THIS DRAWING, OR ANY RELIANCE ON OR DECISIONS TO BE MADE BASED ON IT, ARE THE RESPONSIBILITY OF SUCH THIRD PARTIES. KNIGHT PIESOLD ACCEPTS NO RESPONSIBILITY FOR DAMAGES, IF ANY, SUFFERED BY THE THIRD PARTY AS A RESULT OF DECISIONS MADE OR ACTIONS BASED ON THIS DRAWING. COPIES RESULTING FROM ELECTRONIC TRANSFER OR REPRODUCTION OF THIS DRAWING ARE UNCONTROLLED AND MAY NOT BE THE MOST RECENT REVISION OF THIS DRAWING.		
<i>Knight Piésold</i> CONSULTING		
TINTINA RESOURCES INC.		
BLACK BUTTE COPPER PROJECT		
CEMENTED TAILINGS FACILITY SEEPAGE COLLECTION AND RECLAIM SYSTEM PLAN AND PROFILE		
PIA NO.	DRAWING NO.	REVISION
VA101-460/3	C6210	2

SAV: M:\11004603\VA101-460\DWG\C6220\C6220_1_4272016 3:57:56 PM, RPENG PRINTED: 4/27/2016 3:58:11 PM, C6220, RPENG
 XREF FILES: F:\DWG\DWG\C6220\C6220_1_4272016 3:57:56 PM, RPENG

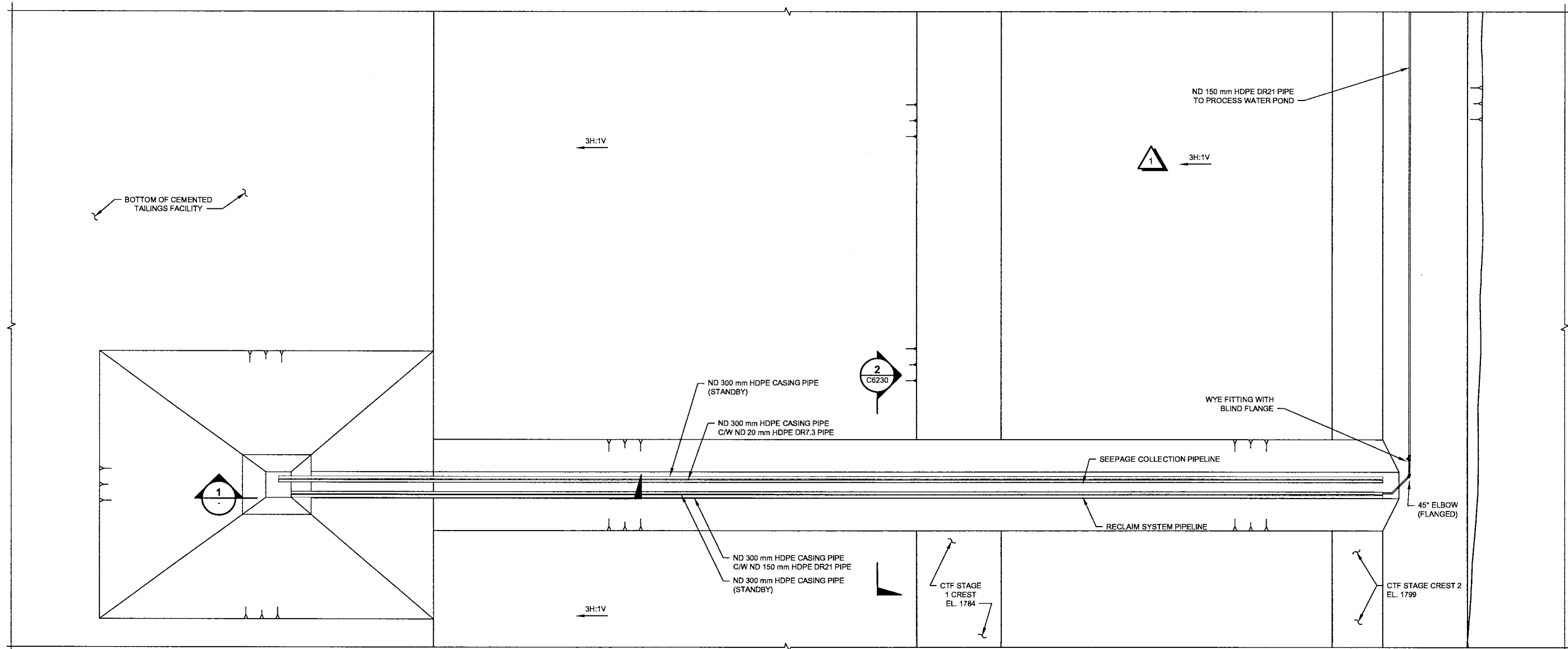

A
C6210
DETAIL
CTF RECLAIM SYSTEM AND
SEEPAGE COLLECTION SUMP
SCALE A

FOR INFORMATION ONLY

NOTES:

- DIMENSIONS AND ELEVATIONS ARE IN MILLIMETERS, UNLESS NOTED OTHERWISE.

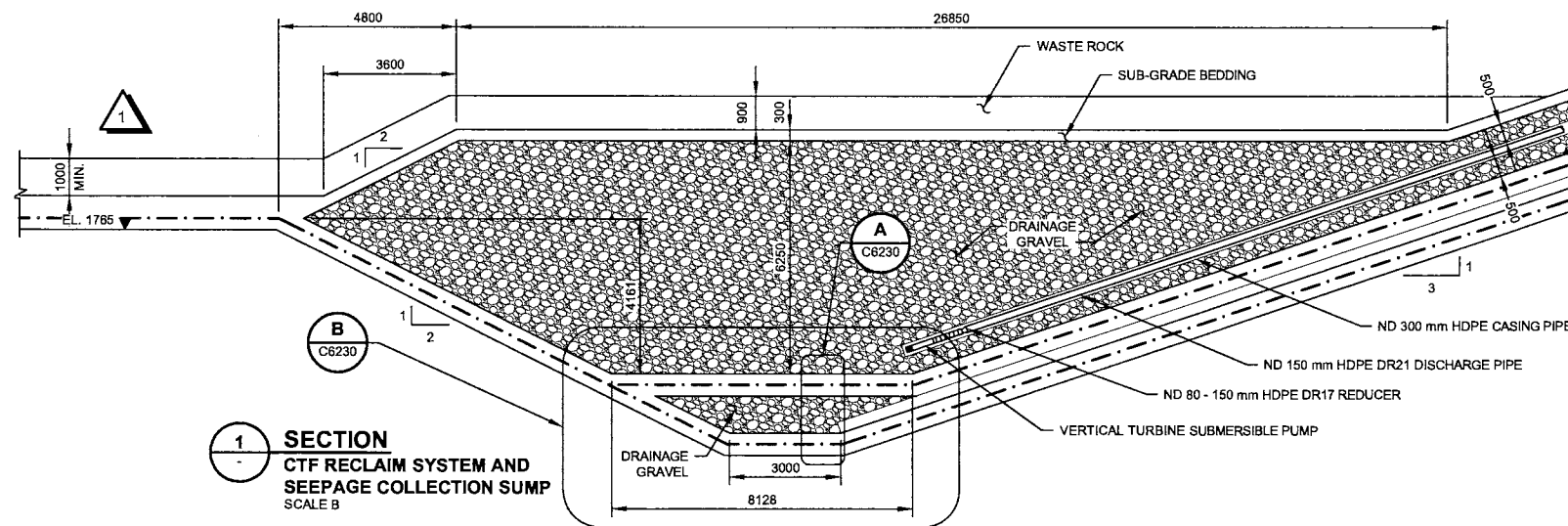
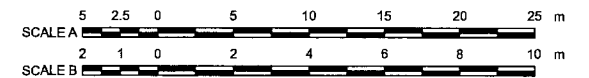

1
C6230
SECTION
CTF RECLAIM SYSTEM AND
SEEPAGE COLLECTION SUMP
SCALE B

- DISCLAIMER -
THIS DRAWING WAS PREPARED BY KNIGHT PIESOLD LTD. FOR THE ACCOUNT OF THE CLIENT LISTED ON THIS DRAWING. THE MATERIAL ON IT REFLECTS KNIGHT PIESOLD'S BEST JUDGMENT IN THE LIGHT OF THE INFORMATION AVAILABLE TO IT AT THE TIME OF PREPARATION. ANY USE WHICH A THIRD PARTY MAKES OF THIS DRAWING, OR ANY RELIANCE ON OR DECISIONS TO BE MADE BASED ON IT, ARE THE RESPONSIBILITY OF SUCH THIRD PARTY. KNIGHT PIESOLD ACCEPTS NO RESPONSIBILITY FOR DAMAGES, IF ANY, SUFFERED BY THE THIRD PARTY AS A RESULT OF DECISIONS MADE OR ACTIONS BASED ON THIS DRAWING. COPIES RESULTING FROM ELECTRONIC TRANSFER OR REPRODUCTION OF THIS DRAWING ARE UNCONTROLLED AND MAY NOT BE THE MOST RECENT REVISION OF THIS DRAWING.

Knight Piesold
CONSULTING

TINTINA RESOURCES INC.

BLACK BUTTE COPPER PROJECT

**CEMENTED TAILINGS FACILITY
WATER MANAGEMENT SYSTEMS
TYPICAL SECTIONS - 1 OF 2**

DRG. NO.	DESCRIPTION	REV	DATE	DESIGNED	DRAWN	REVIEWED	APPROVED
C6230	CTF - WATER MANAGEMENT SYSTEMS - TYPICAL SECTIONS - 2 OF 2						
C6210	CEMENTED TAILINGS FACILITY TO PROCESS WATER POND - PLAN & PROFILE						

REV	DATE	DESCRIPTION	DESIGNED	DRAWN	REVIEWED	APPROVED
1	29APR'16	SLOPE AND WASTE ROCK THICKNESS REVISED	GIM	RAP	KDE	KDE
0	15OCT'15	ISSUED FOR MOP APPLICATION	JEF	KJM	KDE	KDE

REV	DATE	DESCRIPTION	DESIGNED	DRAWN	REVIEWED	APPROVED
1	29APR'16	SLOPE AND WASTE ROCK THICKNESS REVISED	GIM	RAP	KDE	KDE
0	15OCT'15	ISSUED FOR MOP APPLICATION	JEF	KJM	KDE	KDE

P/A NO.	DRAWING NO.	REVISION
VA101-460/3	C6220	1

C:\Users\m11101460\OneDrive\Documents\C6250\C6250_1_4272016 3:36:59 PM, RPENG PRINTED: 4/27/2016 3:37:09 PM, LAYOUT, RPENG
 SAVE AS: M:\1101460\OneDrive\Documents\C6250\C6250_1_4272016 3:36:59 PM, RPENG PRINTED: 4/27/2016 3:37:09 PM, LAYOUT, RPENG
 SAVE AS: M:\1101460\OneDrive\Documents\C6250\C6250_1_4272016 3:36:59 PM, RPENG PRINTED: 4/27/2016 3:37:09 PM, LAYOUT, RPENG

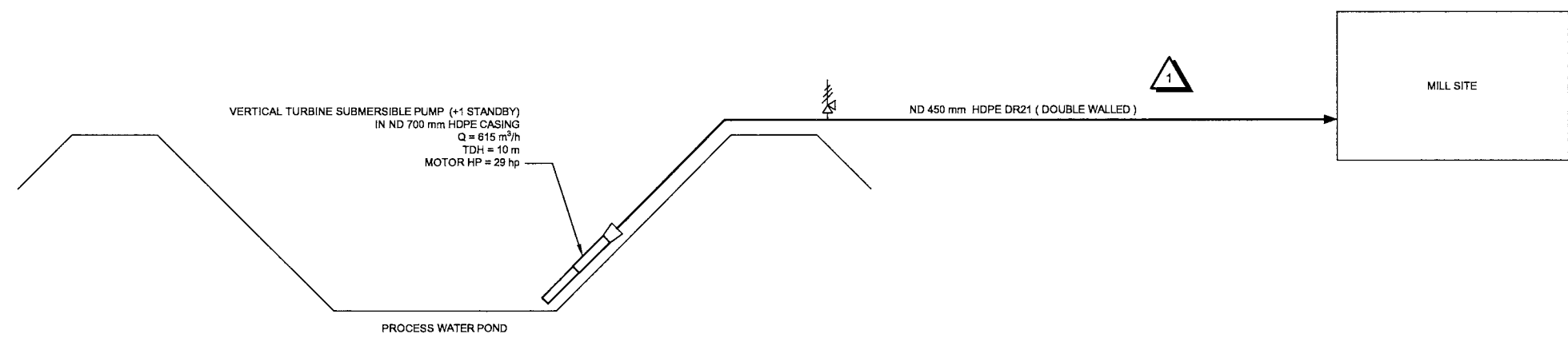

- LEGEND:**
- PIPE
 - ▶ FLOW DIRECTION
 - ⊕ COMBINATION AIR VALVE
 - ◻ REDUCER
 - ▭ VERTICAL TURBINE SUBMERSIBLE PUMP

FOR INFORMATION ONLY

- DISCLAIMER - <small>THIS DRAWING WAS PREPARED BY KNIGHT PIESOLD LTD. FOR THE ACCOUNT OF THE CLIENT LISTED ON THIS DRAWING. THE MATERIAL ON IT REFLECTS KNIGHT PIESOLD'S BEST JUDGMENT IN THE LIGHT OF THE INFORMATION AVAILABLE TO IT AT THE TIME OF PREPARATION. ANY USE WHICH A THIRD PARTY MAKES OF THIS DRAWING OR ANY RELIANCE ON OR DECISIONS TO BE MADE BASED ON IT, ARE THE RESPONSIBILITY OF SUCH THIRD PARTIES. KNIGHT PIESOLD ACCEPTS NO RESPONSIBILITY FOR DAMAGES, IF ANY, SUFFERED BY THE THIRD PARTY AS A RESULT OF DECISIONS MADE OR ACTIONS BASED ON THIS DRAWING. COPIES RESULTING FROM ELECTRONIC TRANSFER OR REPRODUCTION OF THIS DRAWING ARE UNCONTROLLED AND MAY NOT BE THE MOST RECENT REVISION OF THIS DRAWING.</small>	 KNIGHT PIESOLD CONSULTING
TINTINA RESOURCES INC.	
BLACK BUTTE COPPER PROJECT	
RECLAIM WATER DELIVERY SYSTEM PROCESS WATER POND TO MILL SITE PIPING AND INSTRUMENTATION DIAGRAM	
P/A NO.	DRAWING NO.
VA101-460/3	C6250
REVISION	
1	

DRG. NO.	DESCRIPTION	REV	DATE	DESIGNED	DRAWN	REVIEWED	APPROVED	REV	DATE	DESCRIPTION	DESIGNED	DRAWN	REVIEWED	APPROVED
C6250	RECLAIM WATER DELIVERY SYSTEM - PWP TO MILL SITE - PLAN AND PROFILE							1	29APR'16	DISCHARGE PIPE SIZE REVISED	GIM	RAP	K	K
								0	15OCT'15	ISSUED FOR MOP APPLICATION	MAP	KJM	KJB	KJB

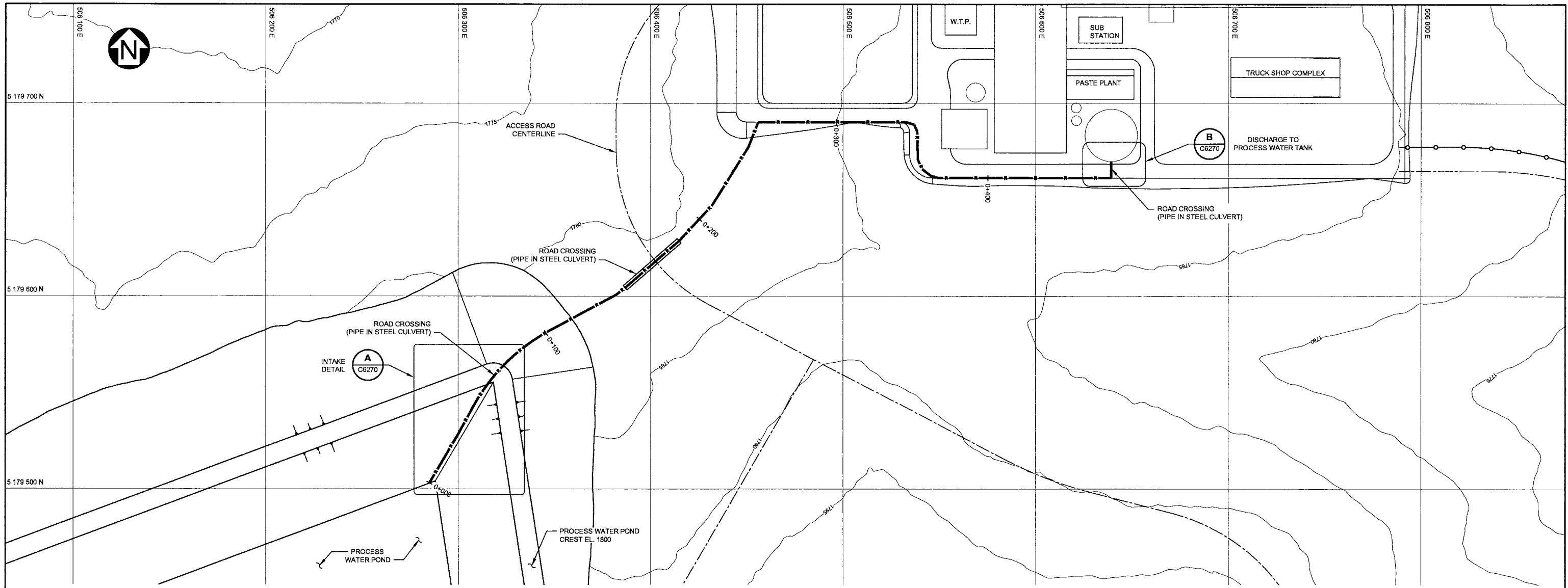

PLAN
SCALE A

LEGEND:
 RECLAIM WATER PIPELINE

- NOTES:
- COORDINATE GRID IS UTM NAD83 ZONE 12.
 - CONTOUR INTERVAL IS 1 METER.
 - DIMENSIONS AND ELEVATIONS ARE IN METERS, UNLESS NOTED OTHERWISE.

FOR INFORMATION ONLY

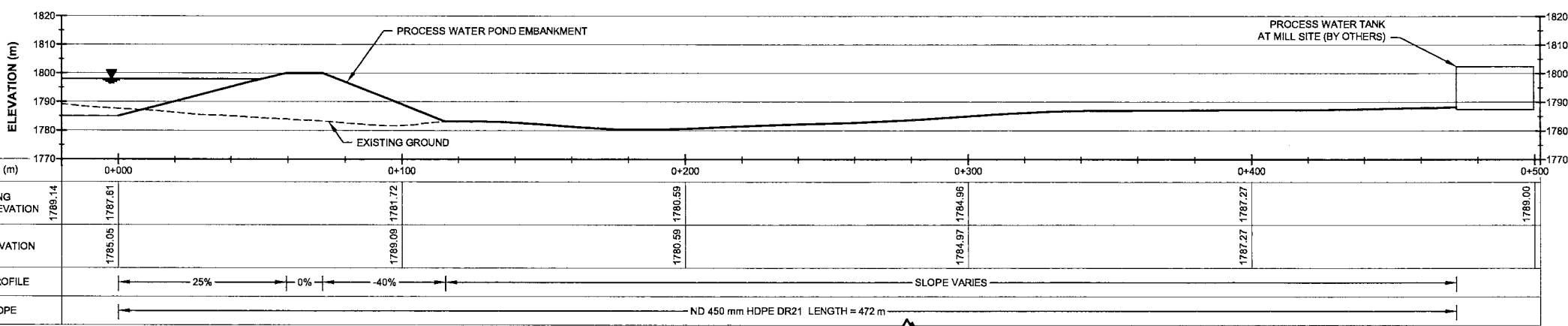

PROFILE
SCALE A

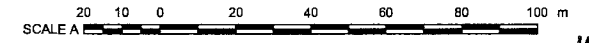

DISCLAIMER
 THIS DRAWING WAS PREPARED BY KNIGHT PIESOLD LTD. FOR THE ACCOUNT OF THE CLIENT LISTED ON THIS DRAWING. THE MATERIAL ON IT REFLECTS KNIGHT PIESOLD'S BEST JUDGMENT IN THE LIGHT OF THE INFORMATION AVAILABLE TO IT AT THE TIME OF PREPARATION. ANY USE WHICH A THIRD PARTY MAKES OF THIS DRAWING, OR ANY RELIANCE ON OR DECISIONS TO BE MADE BASED ON IT, ARE THE RESPONSIBILITY OF SUCH THIRD PARTIES. KNIGHT PIESOLD ACCEPTS NO RESPONSIBILITY FOR DAMAGES, IF ANY, SUFFERED BY THE THIRD PARTY AS A RESULT OF DECISIONS MADE OR ACTIONS BASED ON THIS DRAWING. COPIES RESULTING FROM ELECTRONIC TRANSFER OR REPRODUCTION OF THIS DRAWING ARE UNCONTROLLED AND MAY NOT BE THE MOST RECENT REVISION OF THIS DRAWING.

Knight Piesold
CONSULTING

TINTINA RESOURCES INC.

BLACK BUTTE COPPER PROJECT

RECLAIM WATER DELIVERY SYSTEM
PROCESS WATER POND TO MILL SITE
PLAN AND PROFILE

DRG. NO.	DESCRIPTION	REV	DATE	DESIGNED	DRAWN	REVIEWED	APPROVED
C6250	RECLAIM WATER DELIVERY SYSTEM - PWP TO MILL SITE - P&ID						
C6270	RECLAIM WATER DELIVERY SYSTEM - PWP TO MILL SITE - TYPICAL SECTIONS						

REV	DATE	DESCRIPTION	DESIGNED	DRAWN	REVIEWED	APPROVED
REVISIONS						

REV	DATE	DESCRIPTION	DESIGNED	DRAWN	REVIEWED	APPROVED
1	29APR'16	DISCHARGE PIPE SIZE REVISED	GIM	RAP	KJB	KJB
0	15OCT'15	ISSUED FOR MOP APPLICATION	RSS	KJM	KJB	KJB
REVISIONS						

P/A NO.	DRAWING NO.	REVISION
VA101-460/3	C6260	1

SAVED: M:\110100460\03\AA\acard\DWG\C6260.rvt, 4/27/2016 3:36:01 PM, RPENG PRINTED: 4/27/2016 3:36:12 PM, layout, RPENG
 XREF FILE(S): Topo, Inv, Facility, PWP, ACCESS ROAD AND HAUL RD, IMAGE FILE(S)

SAVED: M:\1101460\03\AA\work\DRAWINGS\C6270\C6270_1_1_4272016 3:34:35 PM, RPENG PRINTED: 4/27/2016 3:34:48 PM, C6204, RPENG
 XREF FILES: PWP_1.dwg (IMAGE FILE(S))

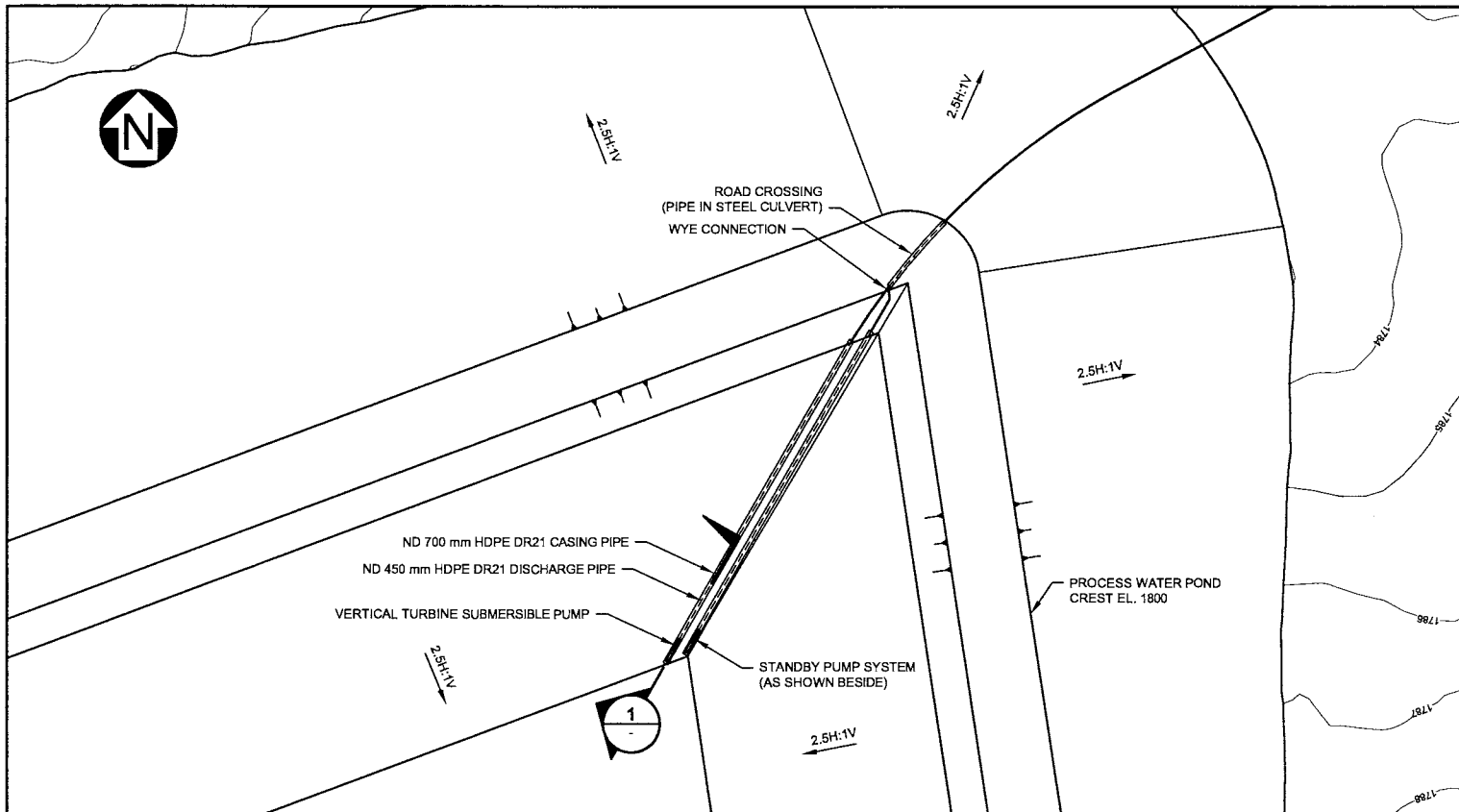

A
C6260
DETAIL
PROCESS WATER POND INTAKE
SCALE A

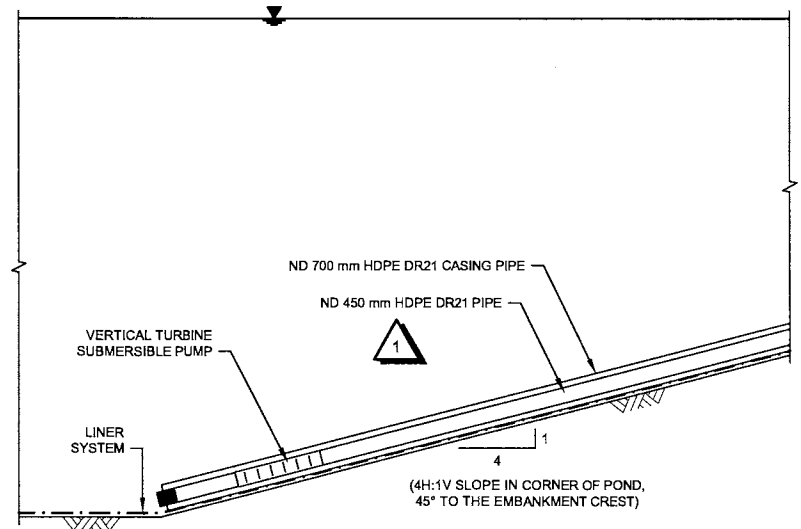

1
C6260
SECTION
PROCESS WATER POND INTAKE
SCALE B

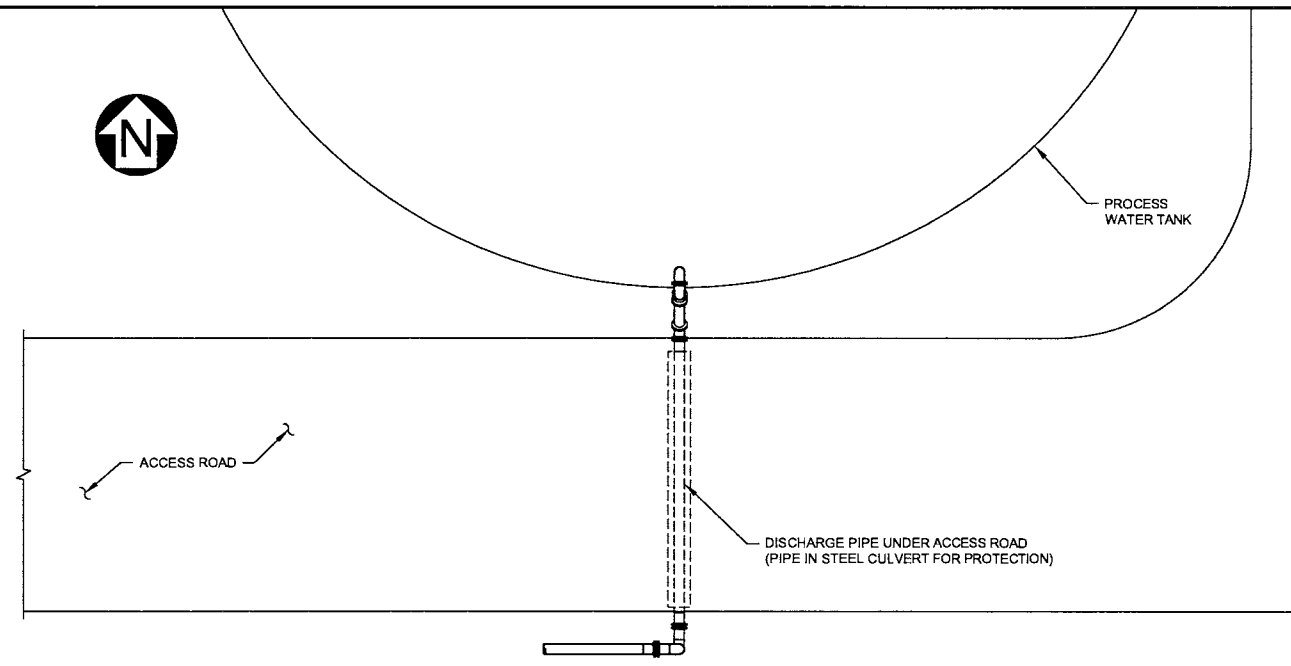

B
C6260
DETAIL
DISCHARGE TO PROCESS WATER TANK
SCALE B

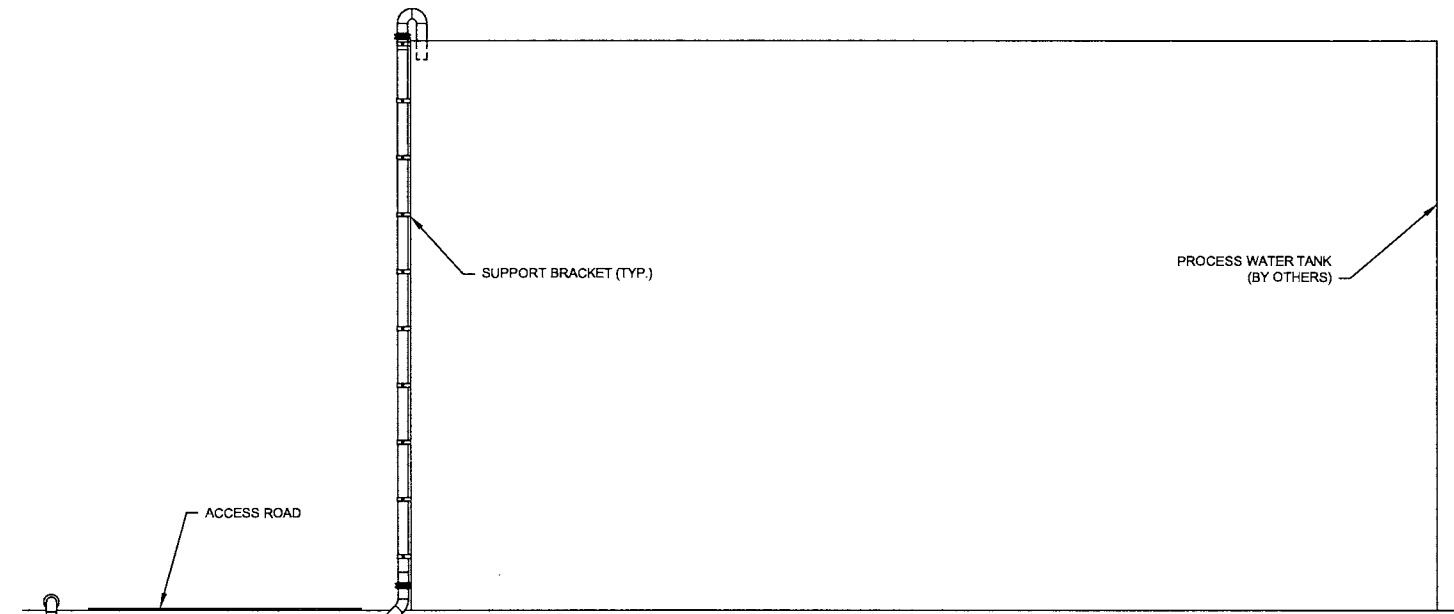

2
C6260
SECTION
DISCHARGE TO PROCESS WATER TANK
SCALE B

FOR INFORMATION ONLY

NOTES:

- DIMENSIONS AND ELEVATIONS ARE IN MILLIMETERS, UNLESS NOTED OTHERWISE.

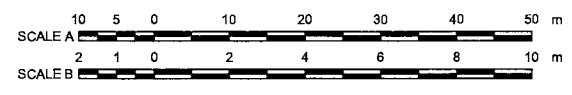

DISCLAIMER
 THIS DRAWING WAS PREPARED BY KNIGHT PIESOLD LTD. FOR THE ACCOUNT OF THE CLIENT LISTED ON THIS DRAWING. THE MATERIAL ON IT REFLECTS KNIGHT PIESOLD'S BEST JUDGMENT IN THE LIGHT OF THE INFORMATION AVAILABLE TO IT AT THE TIME OF PREPARATION. ANY USE WHICH A THIRD PARTY MAKES OF THIS DRAWING OR ANY RELIANCE ON OR DECISIONS TO BE MADE BASED ON IT, ARE THE RESPONSIBILITY OF SUCH THIRD PARTIES. KNIGHT PIESOLD ACCEPTS NO RESPONSIBILITY FOR DAMAGES, IF ANY, SUFFERED BY THE THIRD PARTY AS A RESULT OF DECISIONS MADE OR ACTIONS BASED ON THIS DRAWING. COPIES RESULTING FROM ELECTRONIC TRANSFER OR REPRODUCTION OF THIS DRAWING ARE UNCONTROLLED AND MAY NOT BE THE MOST RECENT REVISION OF THIS DRAWING.

Knight Piesold
CONSULTING

TINTINA RESOURCES INC.

BLACK BUTTE COPPER PROJECT

**RECLAIM WATER DELIVERY SYSTEM
PROCESS WATER POND TO MILL SITE
TYPICAL SECTIONS**

DRG. NO.	DESCRIPTION	REV	DATE	DESIGNED	DRAWN	REVIEWED	APPROVED
C6260	RECLAIM WATER DELIVERY SYSTEM - PWP TO MILL SITE - PLAN AND PROFILE						





REV	DATE	DESCRIPTION	DESIGNED	DRAWN	REVIEWED	APPROVED
1	29APR'16	DISCHARGE PIPE SIZE REVISED				
0	15OCT'15	ISSUED FOR MOP APPLICATION				

REV	DATE	DESCRIPTION	DESIGNED	DRAWN	REVIEWED	APPROVED
1	29APR'16	DISCHARGE PIPE SIZE REVISED	GIM	RAP	<i>[Signature]</i>	<i>[Signature]</i>
0	15OCT'15	ISSUED FOR MOP APPLICATION	MAP	KJM	KJB	KJB

PIA NO.	DRAWING NO.	REVISION
VA101-460/3	C6270	1

P:\PROJECTS\2015\VA101-460\3D\VA101-460-3D\CAD\DWGS\C6300\C6300.dwg, 10/16/2015 8:49:50 AM, PPETKOVIC PRINTED: 10/16/2015 8:49:54 AM, layout, PPETKOVIC

LEGEND:

-  SUBMERSIBLE PUMP
-  COMBINATION AIR VALVE
-  ISOLATION VALVE
-  CHECK VALVE
-  REDUCER

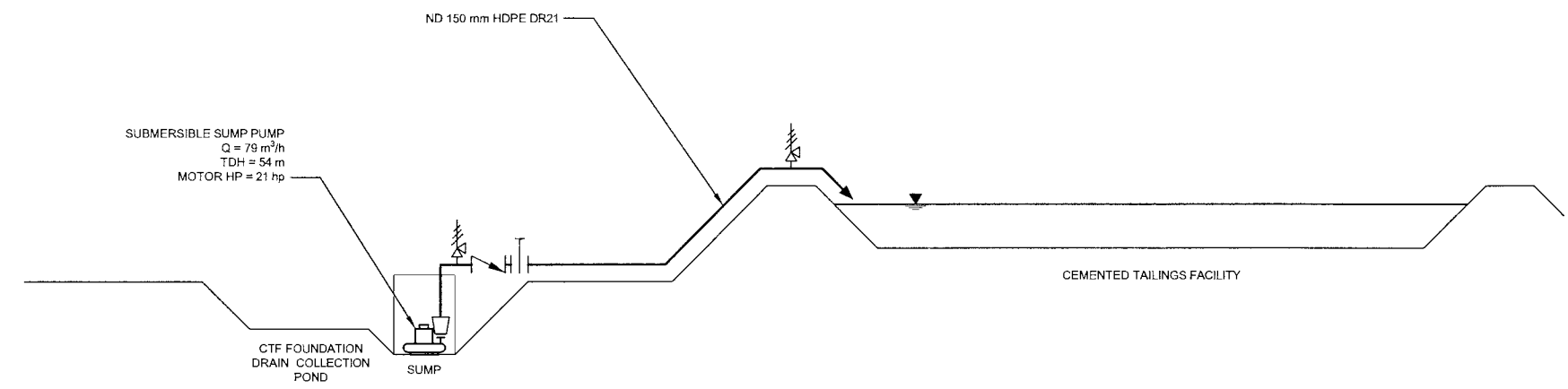

CEMENTED TAILINGS FACILITY FOUNDATION DRAIN PUMPBACK SYSTEM

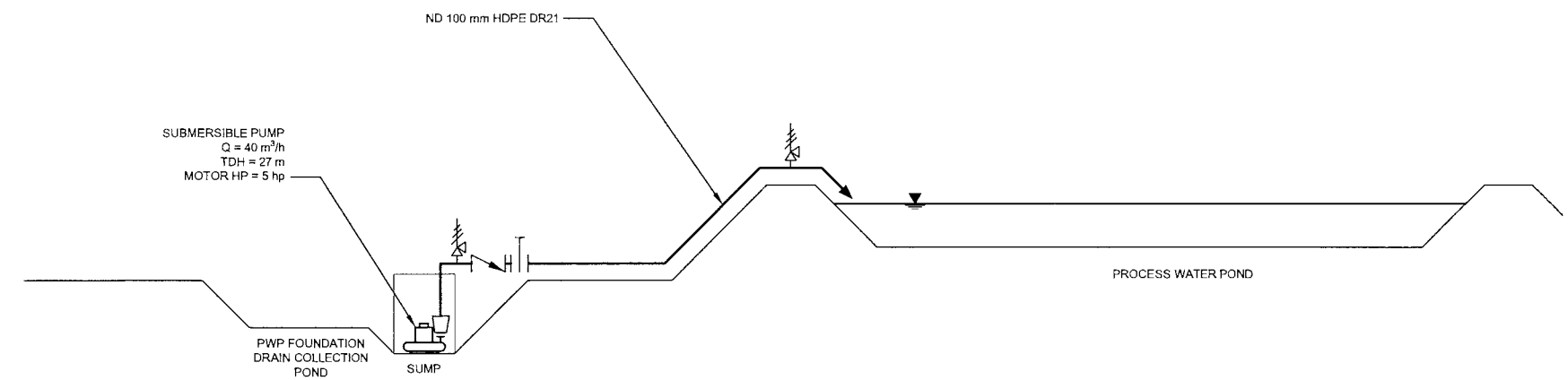

PROCESS WATER POND FOUNDATION DRAIN PUMPBACK SYSTEM

FOR INFORMATION ONLY

- DISCLAIMER - THIS DRAWING WAS PREPARED BY KNIGHT PIESOLD LTD. FOR THE ACCOUNT OF THE CLIENT LISTED ON THIS DRAWING. THE MATERIAL ON IT REFLECTS KNIGHT PIESOLD'S BEST JUDGMENT IN THE LIGHT OF THE INFORMATION AVAILABLE TO IT AT THE TIME OF PREPARATION. ANY USE WHICH A THIRD PARTY MAKES OF THIS DRAWING, OR ANY RELIANCE ON OR DECISIONS TO BE MADE BASED ON IT, ARE THE RESPONSIBILITY OF SUCH THIRD PARTIES. KNIGHT PIESOLD ACCEPTS NO RESPONSIBILITY FOR DAMAGES, IF ANY, SUFFERED BY THE THIRD PARTY AS A RESULT OF DECISIONS MADE OR ACTIONS BASED ON THIS DRAWING. COPIES RESULTING FROM ELECTRONIC TRANSFER OR REPRODUCTION OF THIS DRAWING ARE UNCONTROLLED AND MAY NOT BE THE MOST RECENT REVISION OF THIS DRAWING.	 KNIGHT PIESOLD CONSULTING
TINTINA RESOURCES INC.	
BLACK BUTTE COPPER PROJECT	
FOUNDATION DRAIN PUMPBACK SYSTEM PIPING AND INSTRUMENTATION DIAGRAM	
PIA NO.	DRAWING NO.
VA101-460/3	C6300
REVISION	0

C6320	SEEPAGE COLLECTION AND PUMPBACK SYSTEM - PWP - PLAN AND PROFILE
C6310	SEEPAGE COLLECTION AND PUMPBACK SYSTEM - CTF - PLAN AND PROFILE
DRG. NO.	DESCRIPTION

REV	DATE	DESCRIPTION	DESIGNED	DRAWN	REVIEWED	APPROVED
REVISIONS						

0	15OCT15	ISSUED FOR MOP APPLICATION	MAP	KJM	K.	K.
REV	DATE	DESCRIPTION	DESIGNED	DRAWN	REVIEWED	APPROVED
REVISIONS						

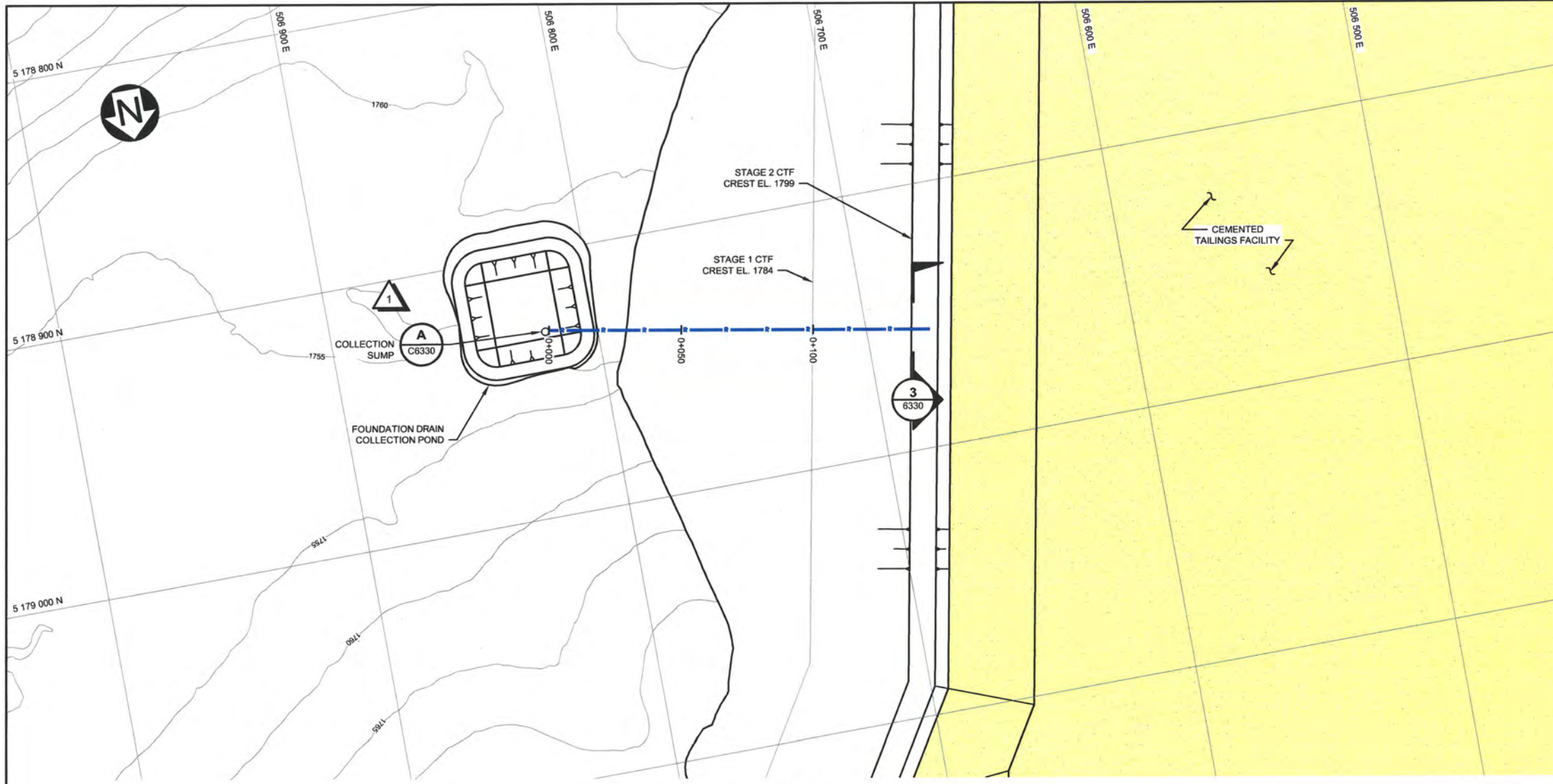

PLAN
SCALE A

LEGEND:
 RECLAIM WATER PIPELINE

- NOTES:**
- COORDINATE GRID IS UTM NAD83 ZONE 12.
 - CONTOUR INTERVAL IS 1 METER.
 - DIMENSIONS AND ELEVATIONS ARE IN METERS, UNLESS NOTED OTHERWISE.

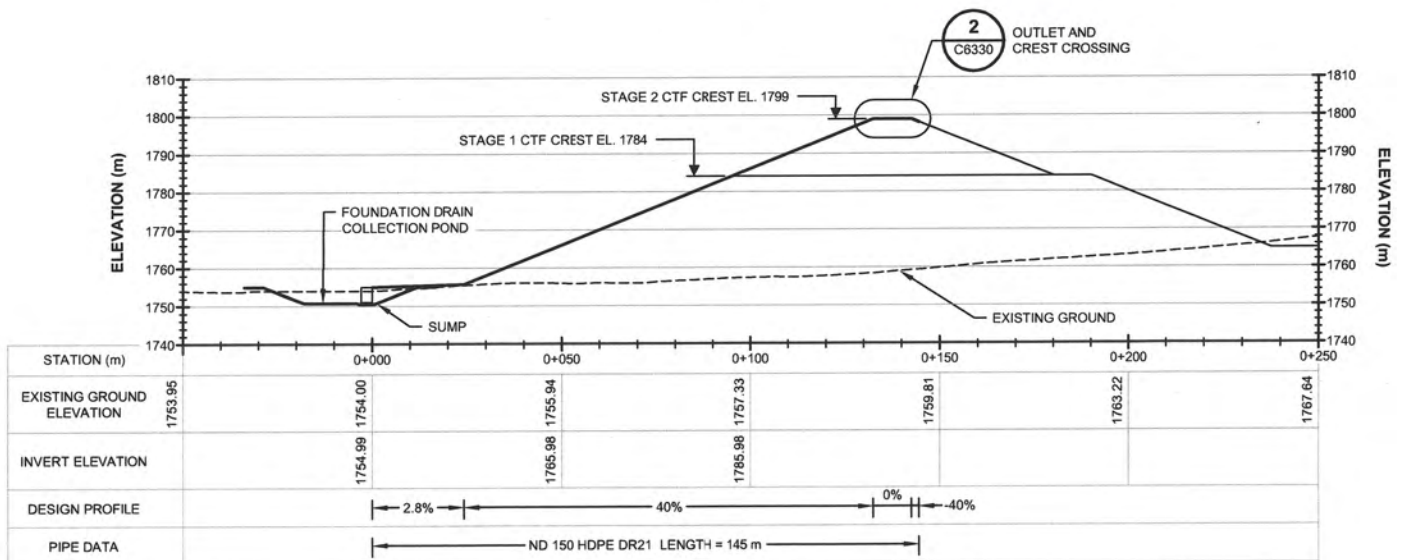

PROFILE
SCALE A

FOR INFORMATION ONLY

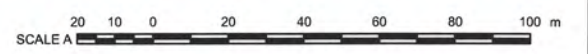

- DISCLAIMER -

THIS DRAWING WAS PREPARED BY KNIGHT PIESOLD LTD. FOR THE ACCOUNT OF THE CLIENT LISTED ON THIS DRAWING. THE MATERIAL ON IT REFLECTS KNIGHT PIESOLD'S BEST JUDGEMENT IN THE LIGHT OF THE INFORMATION AVAILABLE TO IT AT THE TIME OF PREPARATION. ANY USE, WHICH A THIRD PARTY MAKES OF THIS DRAWING, OR ANY RELIANCE ON OR DECISIONS TO BE MADE BASED ON IT, ARE THE RESPONSIBILITY OF SUCH THIRD PARTIES. KNIGHT PIESOLD ACCEPTS NO RESPONSIBILITY FOR DAMAGES, IF ANY, SUFFERED BY THE THIRD PARTY AS A RESULT OF DECISIONS MADE OR ACTIONS BASED ON THIS DRAWING. COPIES RESULTING FROM ELECTRONIC TRANSFER OR REPRODUCTION OF THIS DRAWING ARE UNCONTROLLED AND MAY NOT BE THE MOST RECENT REVISION OF THIS DRAWING.

Knights Piesold
CONSULTING

TINTINA RESOURCES INC.

BLACK BUTTE COPPER PROJECT

**FOUNDATION DRAIN
PUMPBACK SYSTEM
CEMENTED TAILINGS FACILITY
PLAN AND PROFILE**

PIA NO.	DRAWING NO.	REVISION
VA101-460/3	C6310	1

SAVED: M:\110100460\03\Acad\DWG\C6310_C6310_4/28/2016 9:33:51 AM - RPENG PRINTED: 4/28/2016 9:41:04 AM - C6310 - RPENG
 XREF FILES: Top, Im, Facility, PWP, CTF, SZ, CTF, POND, IMAGE FILES

C6300	SEEPAGE COLLECTION AND PUMPBACK SYSTEM - P&I D
C6330	SEEPAGE COLLECTION AND PUMPBACK SYSTEM - TYPICAL SECTIONS
DRG. NO.	DESCRIPTION
REFERENCE DRAWINGS	

REV	DATE	DESCRIPTION	DESIGNED	DRAWN	REVIEWED	APPROVED
REVISIONS						

REV	DATE	DESCRIPTION	DESIGNED	DRAWN	REVIEWED	APPROVED
1	29APR'16	CTF FOUNDATION DRAIN POND REVISED	MAP	RAP	K. K.	K. K.
0	15OCT'15	ISSUED FOR MOP APPLICATION	MAP	KJM	KDE	KDE
REVISIONS						

SAVED: M:\11010046\0301A\Asm\DWG\C6320\C6320.dwg, 10/16/2015 8:57:10 AM, PPETKOVIC, PRINTED: 10/16/2015 8:57:15 AM, layout, PPETKOVIC
 XREF FILES: Top, Utility, PMP, CTF, SZ, PROCESS WATER POND, IMAGE FILES

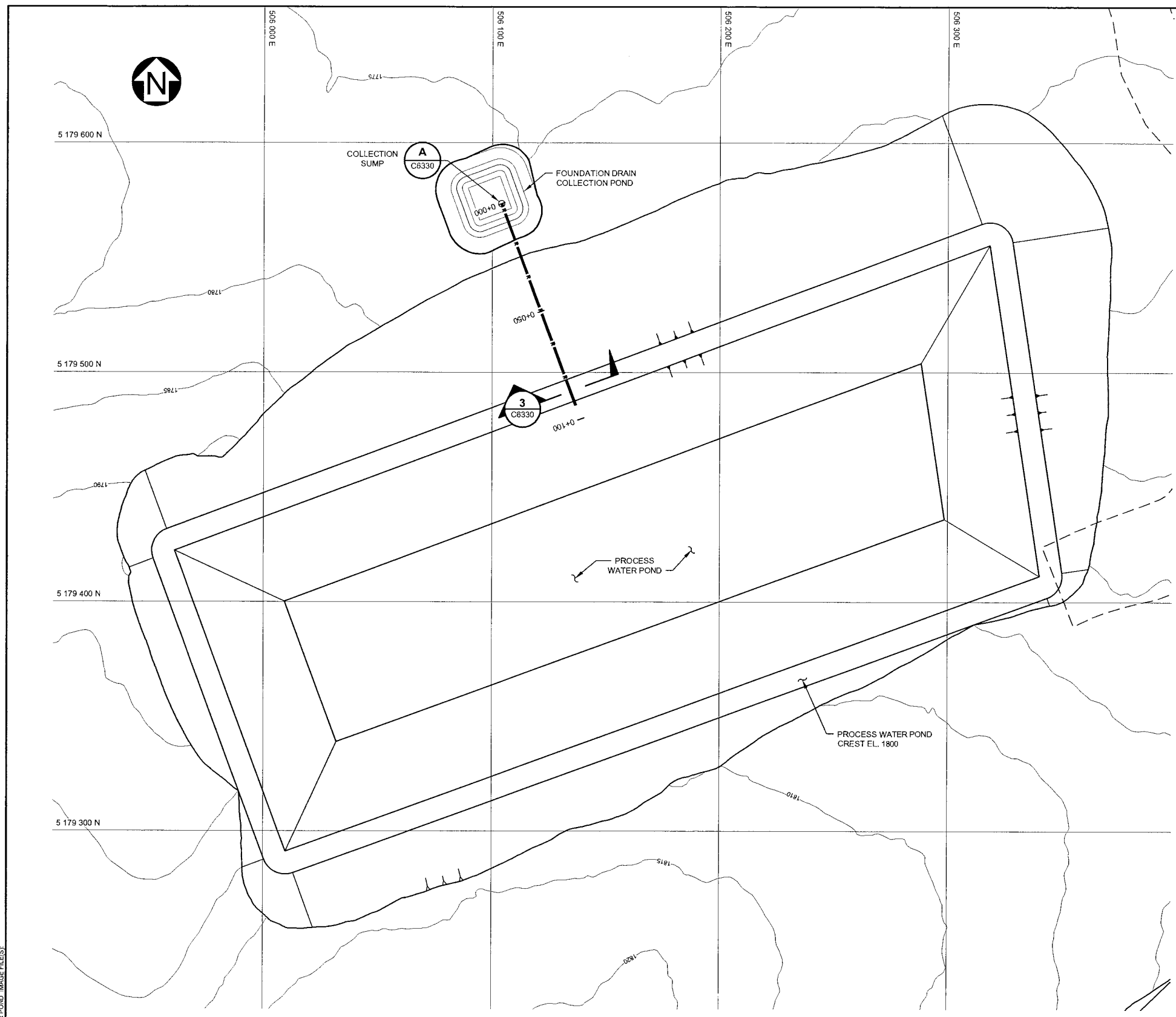

PLAN
SCALE A

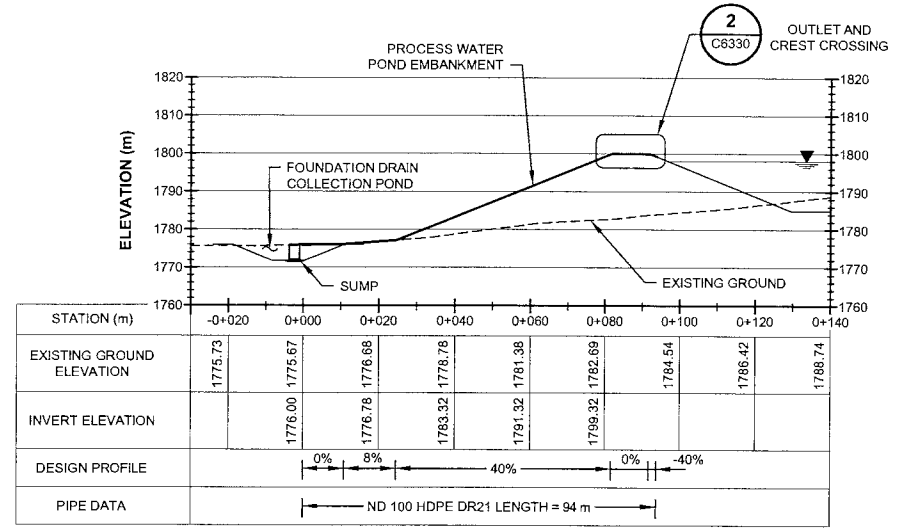

PROFILE
SCALE A

LEGEND:

— R — RECLAIM WATER PIPELINE

NOTES:

- COORDINATE GRID IS UTM NAD83 ZONE 12.
- CONTOUR INTERVAL IS 1 METER.
- DIMENSIONS AND ELEVATIONS ARE IN METERS, UNLESS NOTED OTHERWISE.

FOR INFORMATION ONLY

DRG. NO.	DESCRIPTION	REV	DATE	DESIGNED	DRAWN	REVIEWED	APPROVED
C6300	SEEPAGE COLLECTION AND PUMPBACK SYSTEM - P&ID						
C6330	SEEPAGE COLLECTION AND PUMPBACK SYSTEM - TYPICAL SECTIONS						

REV	DATE	DESCRIPTION	DESIGNED	DRAWN	REVIEWED	APPROVED
0	15OCT15	ISSUED FOR MOP APPLICATION				

REV	DATE	DESCRIPTION	DESIGNED	DRAWN	REVIEWED	APPROVED

DISCLAIMER
 THIS DRAWING WAS PREPARED BY KNIGHT PIESOLD LTD. FOR THE ACCOUNT OF THE CLIENT LISTED ON THIS DRAWING. THE MATERIAL ON IT REPRESENTS KNIGHT PIESOLD'S BEST JUDGEMENT IN THE LIGHT OF THE INFORMATION AVAILABLE TO IT AT THE TIME OF PREPARATION. ANY USE WHICH A THIRD PARTY MAKES OF THIS DRAWING OR ANY RELIANCE ON OR DECISIONS TO BE MADE BASED ON IT, ARE THE RESPONSIBILITY OF SUCH THIRD PARTIES. KNIGHT PIESOLD ACCEPTS NO RESPONSIBILITY FOR DAMAGES, IF ANY, SUFFERED BY THE THIRD PARTY AS A RESULT OF DECISIONS MADE OR ACTIONS BASED ON THIS DRAWING. COPIES RESULTING FROM ELECTRONIC TRANSFER OR REPRODUCTION OF THIS DRAWING ARE UNCONTROLLED AND MAY NOT BE THE MOST RECENT REVISION OF THIS DRAWING.

Knight Piésold
CONSULTING

TINTINA RESOURCES INC.

BLACK BUTTE COPPER PROJECT

**FOUNDATION DRAIN
PUMPBACK SYSTEM
PROCESS WATER POND
PLAN AND PROFILE**

PIA NO.	DRAWING NO.	REVISION
VA101-460/3	C6320	0

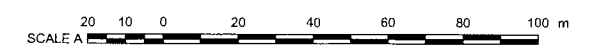

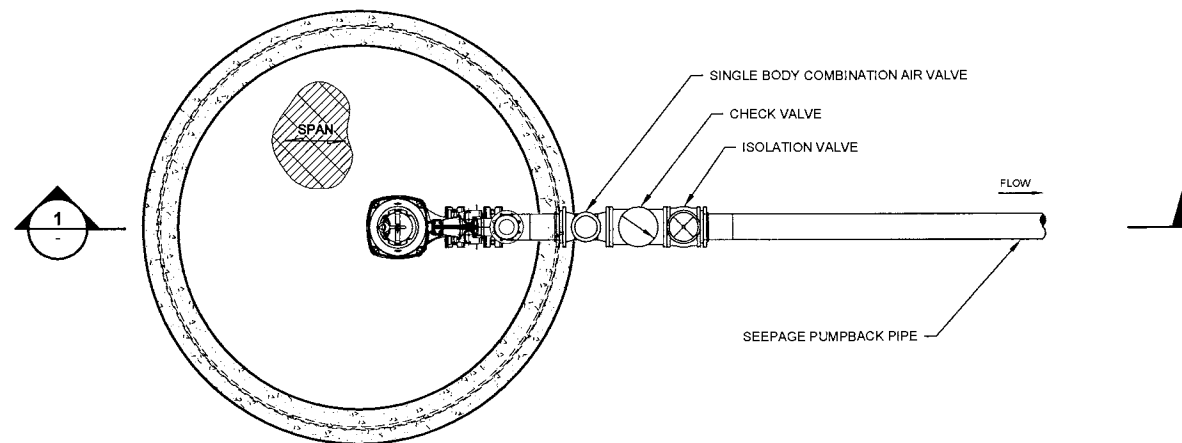

1 **DETAIL**
SUMP IN FOUNDATION DRAIN COLLECTION POND
 NTS

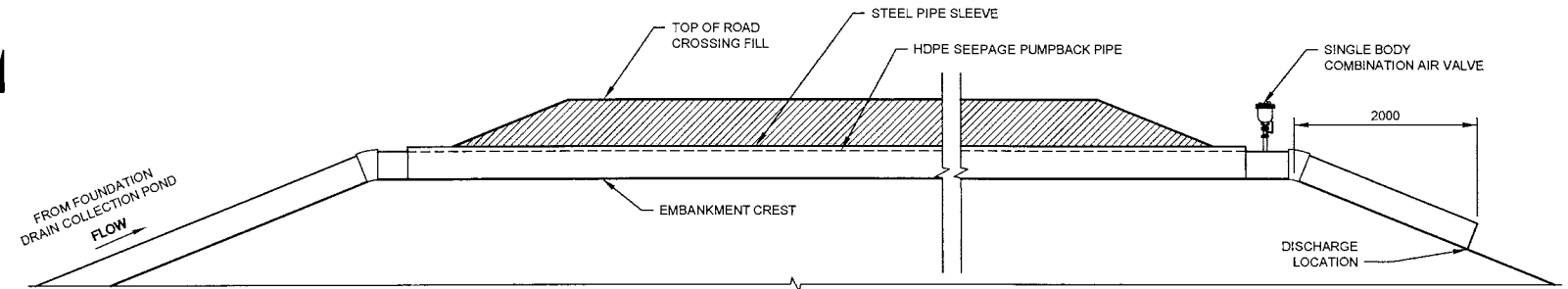

2 **2** **DETAIL**
OUTLET AND CREST CROSSING
 NTS

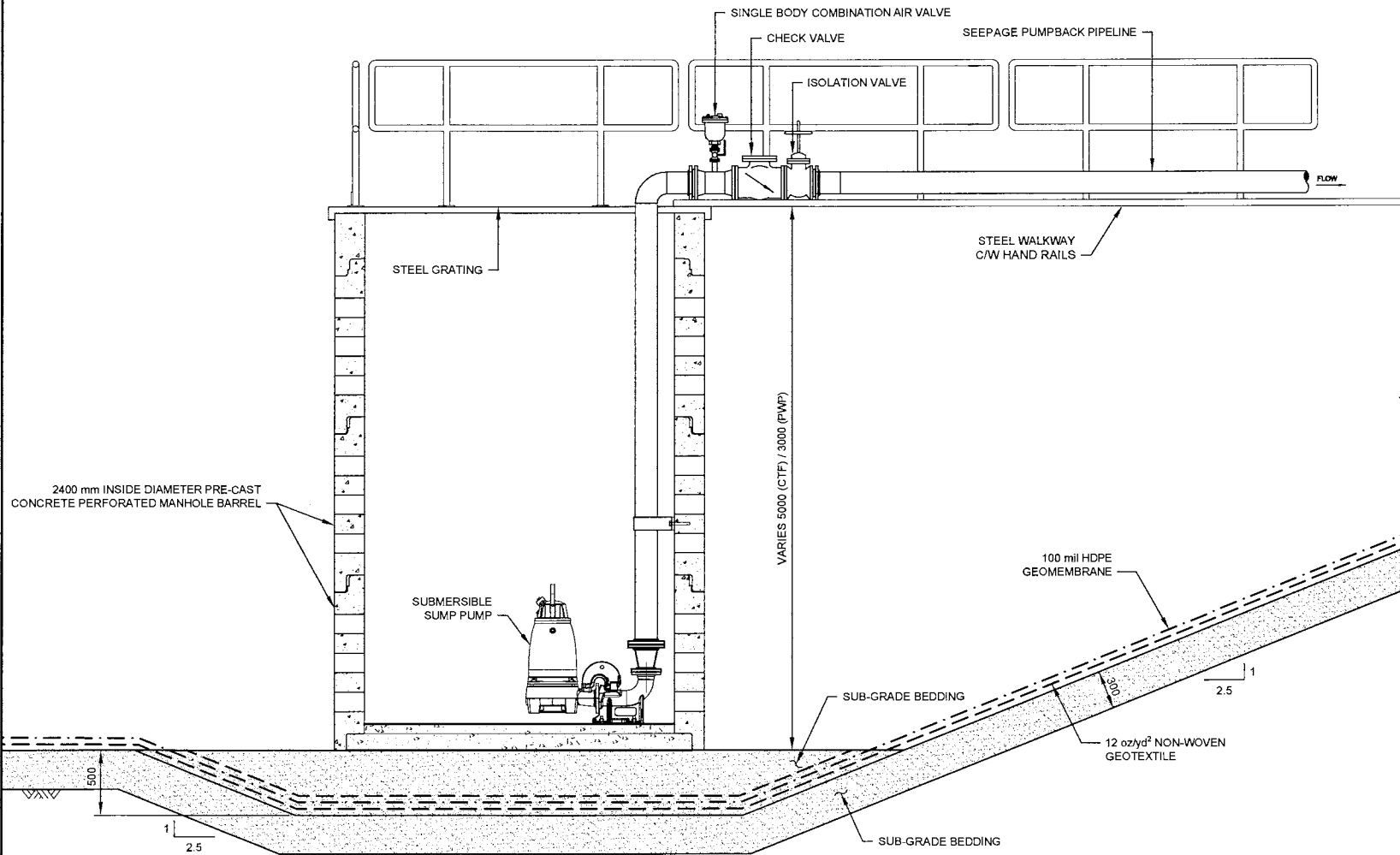

1 **SECTION**
SUMP IN FOUNDATION DRAIN COLLECTION POND
 NTS

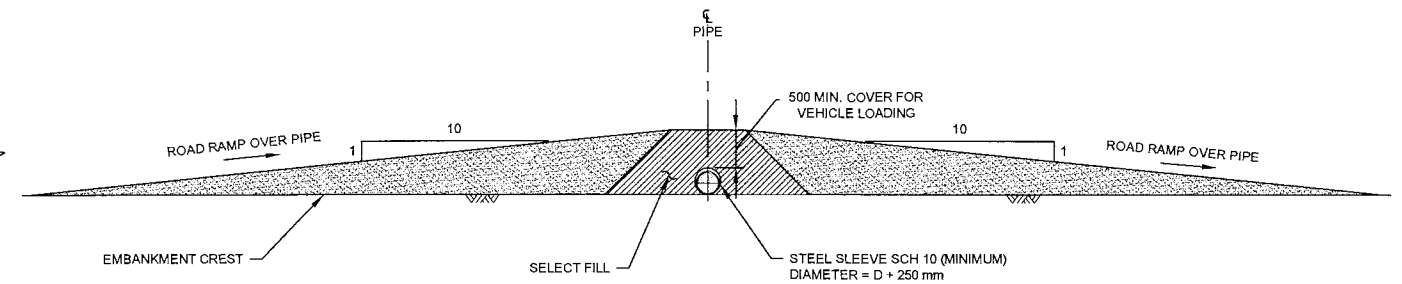

3 **SECTION**
ROAD CROSSING
 NTS

NOTES:

1. DIMENSIONS ARE IN MILLIMETERS, UNLESS NOTED OTHERWISE.

- DISCLAIMER -
 THIS DRAWING WAS PREPARED BY KNIGHT PIESOLD LTD. FOR THE ACCOUNT OF THE CLIENT. THE CLIENT IS RESPONSIBLE FOR THE ACCURACY OF THE INFORMATION AVAILABLE TO IT AT THE TIME OF PREPARATION. ANY USE WHICH A THIRD PARTY MAKES OF THIS DRAWING OR ANY RELIANCE ON OR DECISIONS TO BE MADE BASED ON IT ARE THE RESPONSIBILITY OF SUCH THIRD PARTIES. KNIGHT PIESOLD ACCEPTS NO RESPONSIBILITY FOR DAMAGES, IF ANY, SUFFERED BY THE THIRD PARTY AS A RESULT OF DECISIONS MADE OR ACTIONS BASED ON THIS DRAWING. COPIES RESULTING FROM ELECTRONIC TRANSFER OR REPRODUCTION OF THIS DRAWING ARE UNCONTROLLED AND MAY NOT BE THE MOST RECENT REVISION OF THIS DRAWING.

Knightsold
 CONSULTING

TINTINA RESOURCES INC.

BLACK BUTTE COPPER PROJECT

**FOUNDATION DRAIN POND
 & PUMPBACK SYSTEM
 CEMENTED TAILINGS FACILITY
 AND PROCESS WATER POND
 TYPICAL SECTIONS**

FOR INFORMATION ONLY

C6320	SEEPAGE COLLECTION AND PUMPBACK SYSTEM - PWP - PLAN AND PROFILE
C6310	SEEPAGE COLLECTION AND PUMPBACK SYSTEM - CTF - PLAN AND PROFILE
DRG. NO.	DESCRIPTION
REFERENCE DRAWINGS	

REV	DATE	DESCRIPTION	DESIGNED	DRAWN	REVIEWED	APPROVED
REVISIONS						

0	16OCT'15	ISSUED FOR MOP APPLICATION	MAP	KJM	U.	U.
REV	DATE	DESCRIPTION	DESIGNED	DRAWN	REVIEWED	APPROVED
REVISIONS						

P/A NO.	DRAWING NO.	REVISION
VA101-460/3	C6330	0

SAVED: M:\101\00460\03\VA101-460\DWG\C6330\C6330.dwg, 10/15/2015 11:08:28 AM, PPTKOVIC PRINTED: 10/16/2015 9:09:32 AM, LAYOUT, KMILLER XREF FILES: Top, Int, Facility, PWP, CTF, S2, IMAGE FILES

LEGEND:

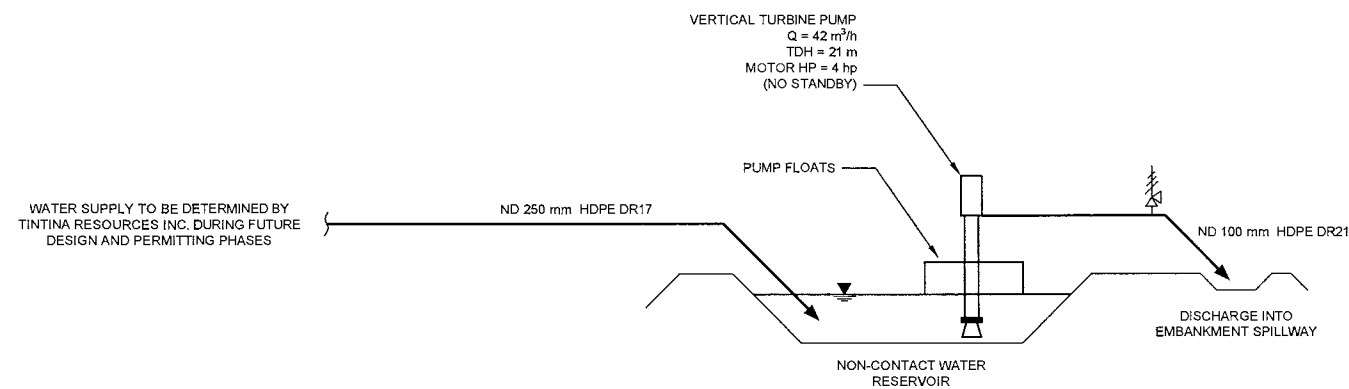
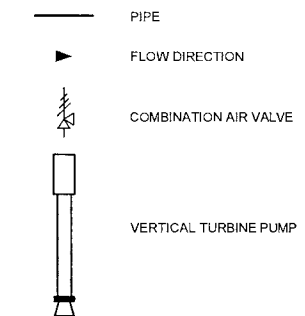

FOR INFORMATION ONLY

<p align="center">- DISCLAIMER -</p> <p><small>THIS DRAWING WAS PREPARED BY KNIGHT PIESOLD LTD. FOR THE ACCOUNT OF THE CLIENT LISTED ON THIS DRAWING. THE MATERIAL ON IT REFLECTS KNIGHT PIESOLD'S BEST JUDGEMENT IN THE LIGHT OF THE INFORMATION AVAILABLE TO IT AT THE TIME OF PREPARATION. ANY USE WHICH A THIRD PARTY MAKES OF THIS DRAWING, OR ANY RELIANCE ON OR DECISIONS TO BE MADE BASED ON IT, ARE THE RESPONSIBILITY OF SUCH THIRD PARTIES. KNIGHT PIESOLD ACCEPTS NO RESPONSIBILITY FOR DAMAGES, IF ANY, SUFFERED BY THE THIRD PARTY AS A RESULT OF DECISIONS MADE OR ACTIONS BASED ON THIS DRAWING. COPIES RESULTING FROM ELECTRONIC TRANSFER OR REPRODUCTION OF THIS DRAWING ARE UNCONTROLLED AND MAY NOT BE THE MOST RECENT REVISION OF THIS DRAWING.</small></p>		
	TINTINA RESOURCES INC.	
	BLACK BUTTE COPPER PROJECT	
NON-CONTACT WATER RESERVOIR SUPPLY AND DISCHARGE SYSTEM PIPING AND INSTRUMENTATION DIAGRAM		
P/A NO.	DRAWING NO.	REVISION
VA101-460/3	C6400	1

1	16NOV'15	ISSUED FOR MOP APPLICATION	MAP	KJM	<i>[Signature]</i>	<i>[Signature]</i>
0	16OCT'15	ISSUED FOR MOP APPLICATION	MAP	KJM	KDE	KDE
REV	DATE	DESCRIPTION	DESIGNED	DRAWN	REVIEWED	APPROVED
REVISIONS			REVISIONS			

XREF FILE(S) IMAGE FILE(S)
 C6430
 NON-CONTACT WATER RESERVOIR - DISCHARGE SYSTEM - PLAN AND PROFILE
 DRG. NO. DESCRIPTION
 REFERENCE DRAWINGS
 DESIGNED DRAWN REVIEWED APPROVED
 REVISIONS
 16NOV'15 ISSUED FOR MOP APPLICATION MAP KJM [Signature] [Signature]
 16OCT'15 ISSUED FOR MOP APPLICATION MAP KJM KDE KDE
 REV DATE DESCRIPTION DESIGNED DRAWN REVIEWED APPROVED
 REVISIONS REVISIONS
 P/A NO. DRAWING NO. REVISION
 VA101-460/3 C6400 1

SAV: 14110100460031A\Acad\DWG\SS\6410\C6410_1_16/20/2017 11:23:16 AM - MCOULTS PRINTED: 6/30/2017 11:40:10 AM, C6410, MCOULTS
 XREF FILES: IMAGE FILES:

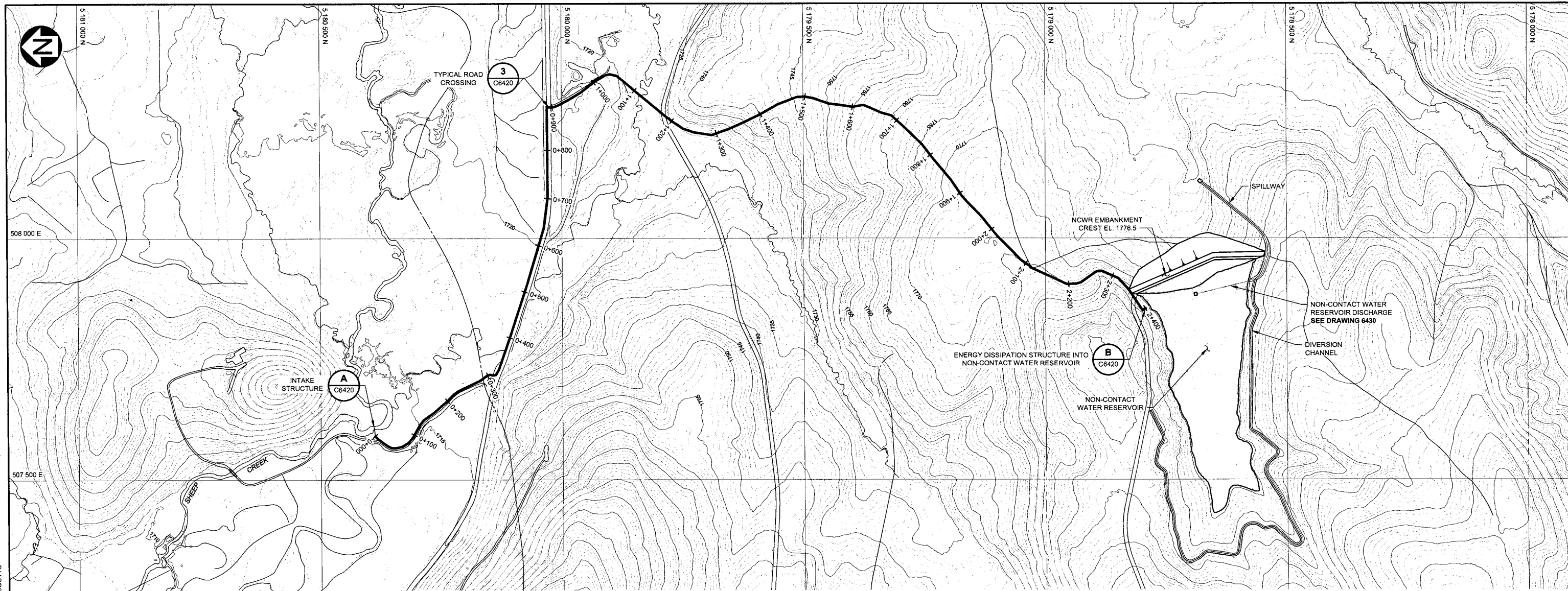

PLAN
SCALE A

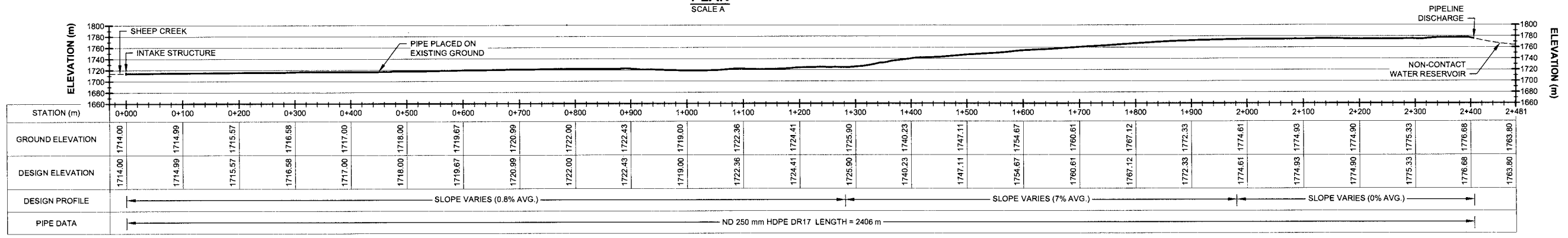

PROFILE
SCALE A

- NOTES:**
- COORDINATE GRID IS UTM NAD83 ZONE 12.
 - CONTOUR INTERVAL IS 1 METER.
 - DIMENSIONS AND ELEVATIONS ARE IN METERS, UNLESS NOTED OTHERWISE.

LEGEND:

- NON-CONTACT WATER SUPPLY
- PROPOSED ACCESS ROADS

FOR INFORMATION ONLY

80 40 0 100 200 300 400 m
SCALE A

DRG. NO.	DESCRIPTION	REV	DATE	DESIGNED	DRAWN	REVIEWED	APPROVED
C6400	NON-CONTACT WATER RESERVOIR - SUPPLY AND DISCHARGE SYSTEM - P&ID						
C6420	NON-CONTACT WATER RESERVOIR - SUPPLY SYSTEM - TYPICAL SECTIONS						
C6430	NON-CONTACT WATER RESERVOIR - DISCHARGE SYSTEM - PLAN & PROFILE						
REFERENCE DRAWINGS		REVISIONS					

REV	DATE	DESCRIPTION	DESIGNED	DRAWN	REVIEWED	APPROVED
1	30JUN'17	ROADS UPDATED	GIM	MJC	<i>[Signature]</i>	<i>[Signature]</i>
0	16OCT'15	ISSUED FOR MOP APPLICATION	MAP	KJM	KDE	KDE
REVISIONS		REVISIONS				

DISCLAIMER - THIS DRAWING WAS PREPARED BY KNIGHT PIESOLD LTD. FOR THE ACCOUNT OF THE CLIENT LISTED ON THIS DRAWING. THE MATERIAL ON IT REFLECTS KNIGHT PIESOLD'S BEST JUDGMENT IN THE LIGHT OF THE INFORMATION AVAILABLE TO IT AT THE TIME OF PREPARATION. ANY USE WHICH A THIRD PARTY MAKES OF THIS DRAWING OR ANY RELIANCE ON OR DECISIONS TO BE MADE BASED ON IT, ARE THE RESPONSIBILITY OF SUCH THIRD PARTIES. KNIGHT PIESOLD ACCEPTS NO RESPONSIBILITY FOR DAMAGES, IF ANY, SUFFERED BY THE THIRD PARTY AS A RESULT OF DECISIONS MADE OR ACTIONS BASED ON THIS DRAWING. COPIES RESULTING FROM ELECTRONIC TRANSFER OR REPRODUCTION OF THIS DRAWING ARE UNCONTROLLED AND MAY NOT BE THE MOST RECENT REVISION OF THIS DRAWING.

Knicht Piesold
CONSULTING

TINTINA RESOURCES INC.

BLACK BUTTE COPPER PROJECT

**NON-CONTACT WATER RESERVOIR
SUPPLY SYSTEM
PLAN AND PROFILE**

P/A NO.	DRAWING NO.	REVISION
VA101-460/3	C6410	1

SAVED: M:\110100460\03\AA\card\DWG\SC6420\06420_1118\2015 8:37:30 AM - KMILLER PRINTED: 11/18/2015 8:41:48 AM, C6420, KMILLER XREF FILE: NCMR - 000 - 000.dwg, Scale: IMAGE FILE(S)



PLAN
ENERGY DISSIPATION STRUCTURE
SCALE A

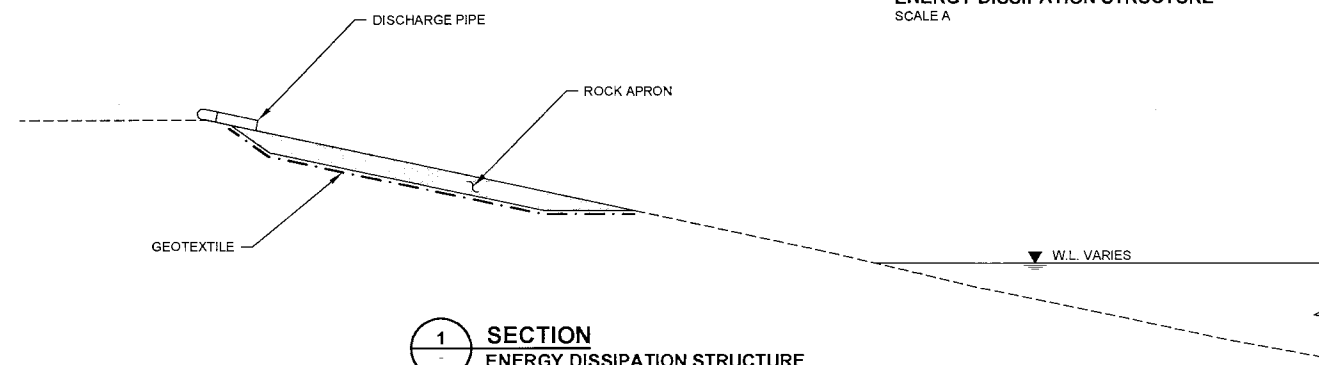

1 SECTION
ENERGY DISSIPATION STRUCTURE
SCALE B

NOTES:

1. COORDINATE GRID IS UTM NAD83 ZONE 12N.
2. CONTOUR INTERVAL IS 1 METER.
3. DIMENSIONS ARE IN MILLIMETERS AND ELEVATIONS ARE IN METERS, UNLESS NOTED OTHERWISE.
4. WATER SUPPLY TO BE DETERMINED BY TINTINA RESOURCES INC. DURING FUTURE DESIGN AND PERMITTING PHASES.

FOR INFORMATION ONLY

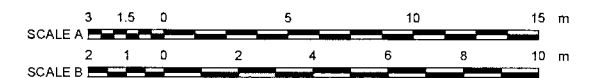

— DISCLAIMER —
THIS DRAWING WAS PREPARED BY KNIGHT PIESOLD LTD. FOR THE ACCOUNT OF THE CLIENT LISTED ON THIS DRAWING. THE MATERIAL ON IT REFLECTS KNIGHT PIESOLD'S BEST JUDGEMENT IN THE LIGHT OF THE INFORMATION AVAILABLE TO IT AT THE TIME OF PREPARATION. ANY USE WHICH A THIRD PARTY MAKES OF THIS DRAWING OR ANY RELIANCE ON OR DECISIONS TO BE MADE BASED ON IT ARE THE RESPONSIBILITY OF SUCH THIRD PARTIES. KNIGHT PIESOLD ACCEPTS NO RESPONSIBILITY FOR DAMAGES, IF ANY, SUFFERED BY THE THIRD PARTY AS A RESULT OF DECISIONS MADE OR ACTIONS BASED ON THIS DRAWING. COPIES RESULTING FROM ELECTRONIC TRANSFER OR REPRODUCTION OF THIS DRAWING ARE UNCONTROLLED AND MAY NOT BE THE MOST RECENT REVISION OF THIS DRAWING.

Knight Piesold
CONSULTING

TINTINA RESOURCES INC.

BLACK BUTTE COPPER PROJECT

**NON-CONTACT WATER RESERVOIR
SUPPLY SYSTEM
DETAILS**

REV	DATE	DESCRIPTION	DESIGNED	DRAWN	REVIEWED	APPROVED
1	16NOV'15	ISSUED FOR MOP APPLICATION	MAP	KJM	<i>[Signature]</i>	<i>[Signature]</i>
0	16OCT'15	ISSUED FOR MOP APPLICATION	MAP	KJM	KDE	KDE

DRG. NO.	DESCRIPTION	REV	DATE	DESIGNED	DRAWN	REVIEWED	APPROVED
	REFERENCE DRAWINGS						
	REVISIONS						

P/A NO.	DRAWING NO.	REVISION
VA101-460/3	C6420	1

SAVED: M:\110100460\03\Acad\DWG\S\C6430\C6430_10/15/2015 11:37:32 AM - PPKOVIC PRINTED: 10/16/2015 9:20:18 AM - C6430_KMILLER

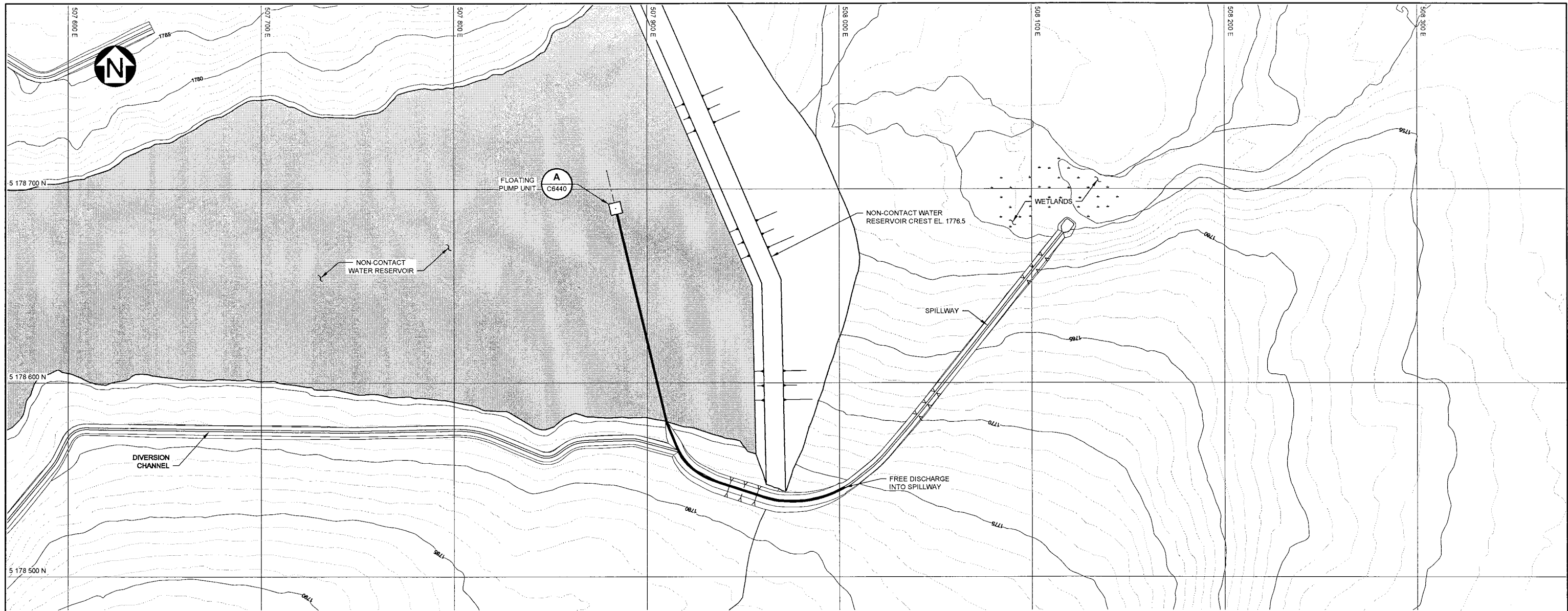

PLAN
SCALE A

LEGEND:

— NON-CONTACT WATER DISCHARGE

NOTES:

1. COORDINATE GRID IS UTM NAD83 ZONE 12.
2. CONTOUR INTERVAL IS 1 METER.
3. DIMENSIONS AND ELEVATIONS ARE IN METERS, UNLESS NOTED OTHERWISE.

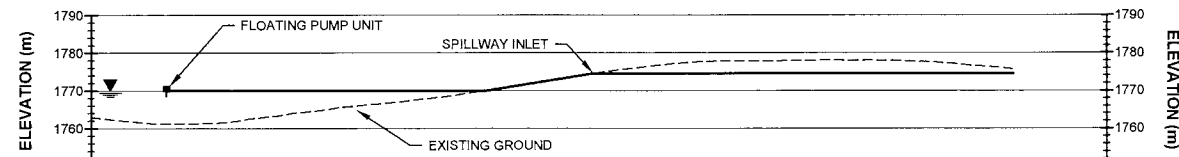

STATION (m)	0+020	0+000	0+050	0+100	0+150	0+200	0+250
GROUND ELEVATION	1762.91	1761.18	1765.89	1772.49	1777.85	1777.69	
DESIGN ELEVATION		1770.00	1770.00	1772.38	1774.50	1774.50	
DESIGN PROFILE	0%		15.85%			0%	
PIPE DATA	ND 100 mm HDPE DR21 DISCHARGE PIPE LENGTH = 225 m						

PROFILE
SCALE A

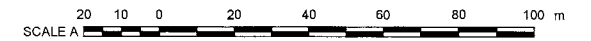

FOR INFORMATION ONLY

DISCLAIMER
THIS DRAWING WAS PREPARED BY KNIGHT PIESOLD FOR THE ACCOUNT OF THE CLIENT LISTED ON THIS DRAWING. THE MATERIAL ON IT REFLECTS KNIGHT PIESOLD'S BEST JUDGMENT IN THE LIGHT OF THE INFORMATION AVAILABLE TO IT AT THE TIME OF PREPARATION. ANY USE WHICH A THIRD PARTY MAKES OF THIS DRAWING OR ANY RELIANCE ON OR DECISIONS TO BE MADE BASED ON IT ARE THE RESPONSIBILITY OF SUCH THIRD PARTIES. KNIGHT PIESOLD ACCEPTS NO RESPONSIBILITY FOR DAMAGES, IF ANY, SUFFERED BY THE THIRD PARTY AS A RESULT OF DECISIONS MADE OR ACTIONS BASED ON THIS DRAWING. COPIES RESULTING FROM ELECTRONIC TRANSFER OR REPRODUCTION OF THIS DRAWING ARE UNCONTROLLED AND MAY NOT BE THE MOST RECENT REVISION OF THIS DRAWING.

***Knights* Piesold**
CONSULTING

TINTINA RESOURCES INC.

BLACK BUTTE COPPER PROJECT

**NON-CONTACT WATER RESERVOIR
DISCHARGE SYSTEM
PLAN AND PROFILE**

C6400	NON-CONTACT WATER RESERVOIR - SUPPLY AND DISCHARGE SYSTEM - P&ID
C6440	NON-CONTACT WATER RESERVOIR - DISCHARGE SYSTEM - TYPICAL SECTIONS

DRG. NO.	DESCRIPTION	REV.	DATE	DESIGNED	DRAWN	REVIEWED	APPROVED
REFERENCE DRAWINGS							
REVISIONS							

0	16OCT15	ISSUED FOR MOP APPLICATION	RSS	KJM	K.	K.
---	---------	----------------------------	-----	-----	----	----

REV.	DATE	DESCRIPTION	DESIGNED	DRAWN	REVIEWED	APPROVED
REVISIONS						

PIA NO.	DRAWING NO.	REVISION
VA101-460/3	C6430	0

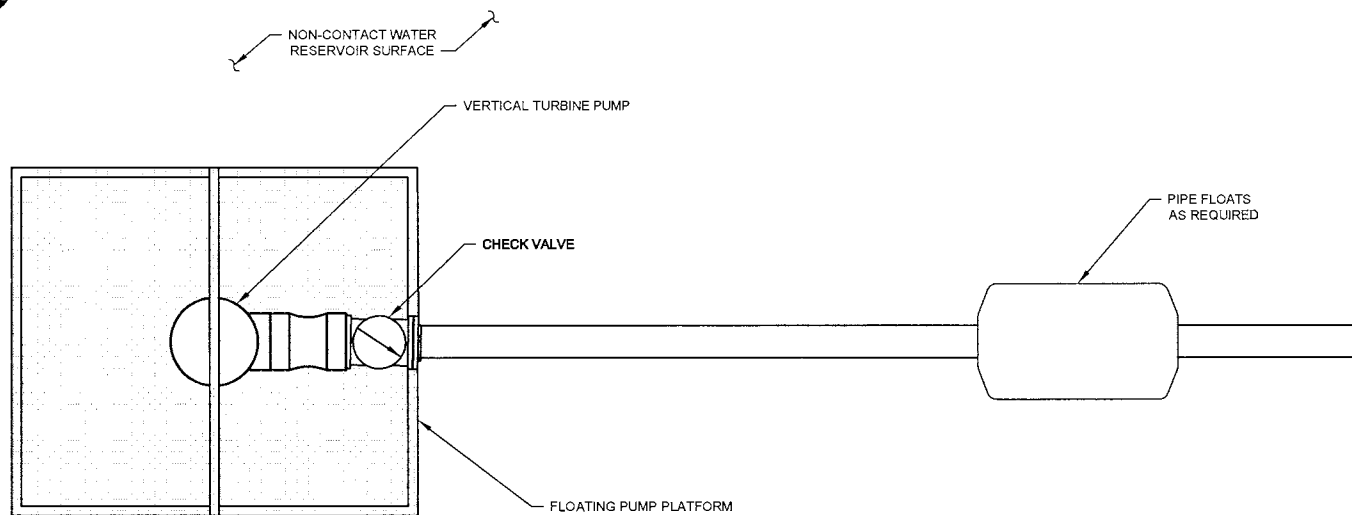

A
C6430 **DETAIL**
FLOATING PUMP UNIT
SCALE A

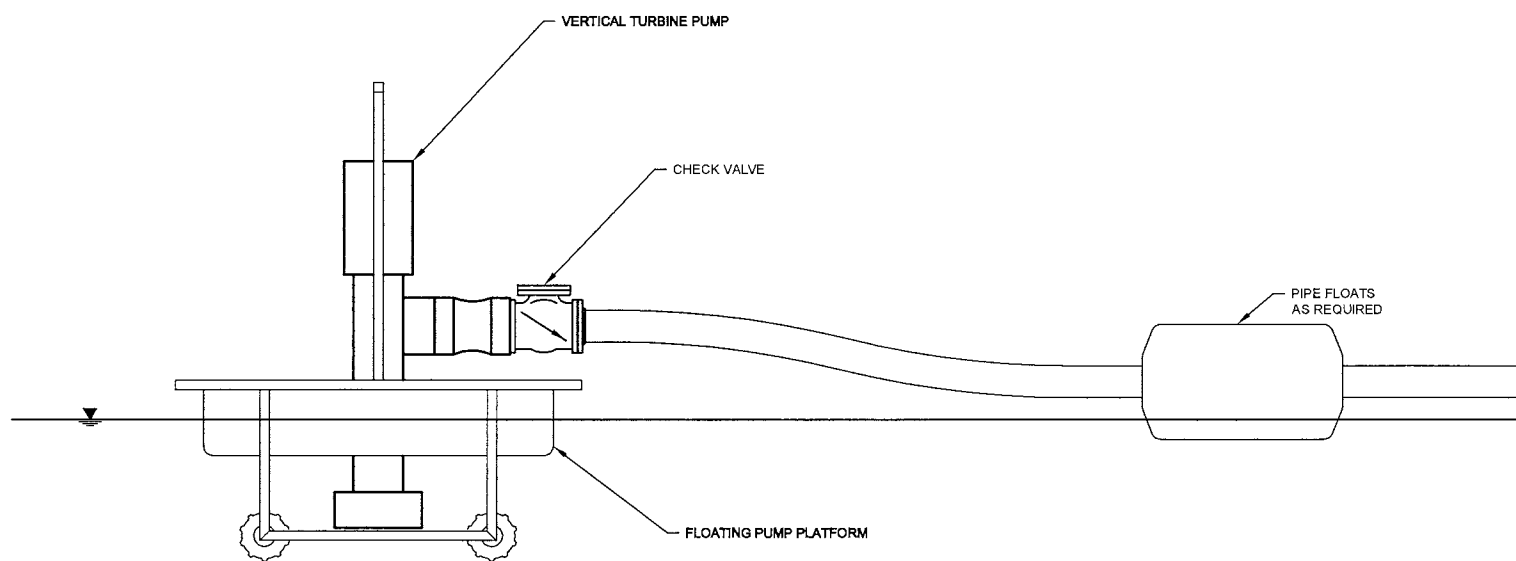

1
C6430 **SECTION**
FLOATING PUMP UNIT
SCALE A



- DISCLAIMER -
THIS DRAWING WAS PREPARED BY KNIGHT PIESOLD LTD. FOR THE ACCOUNT OF THE CLIENT LISTED ON THIS DRAWING. THE MATERIAL ON IT REFLECTS KNIGHT PIESOLD'S BEST JUDGMENT IN THE LIGHT OF THE INFORMATION AVAILABLE TO IT AT THE TIME OF PREPARATION. ANY USE WHICH A THIRD PARTY MAKES OF THIS DRAWING OR ANY RELIANCE ON OR DECISIONS TO BE MADE BASED ON IT, ARE THE RESPONSIBILITY OF SUCH THIRD PARTIES. KNIGHT PIESOLD ACCEPTS NO RESPONSIBILITY FOR DAMAGES, IF ANY, SUFFERED BY THE THIRD PARTY AS A RESULT OF DECISIONS MADE OR ACTIONS BASED ON THIS DRAWING. COPIES RESULTING FROM ELECTRONIC TRANSFER OR REPRODUCTION OF THIS DRAWING ARE UNCONTROLLED AND MAY NOT BE THE MOST RECENT REVISION OF THIS DRAWING.

Knights Piesold
CONSULTING

TINTINA RESOURCES INC.

BLACK BUTTE COPPER PROJECT

**NON-CONTACT WATER RESERVOIR
DISCHARGE SYSTEM
TYPICAL SECTIONS**

FOR INFORMATION ONLY

DRG. NO.	DESCRIPTION	REV	DATE	DESIGNED	DRAWN	REVIEWED	APPROVED
C6430	NON-CONTACT WATER RESERVOIR - DISCHARGE SYSTEM - PLAN AND PROFILE						
REFERENCE DRAWINGS				REVISIONS			
REVISIONS				REVISIONS			

P/A NO.	DRAWING NO.	REVISION
VA101-460/3	C6440	0

SAV: 11/10/10 10:00:03 AM \\c:\p\dwg\c6440_10162015 11:01:01 AM .PPETKOVIC PRINTED: 10/16/2015 9:21:45 AM, layout, KMILLER
 XREF FILES: Top, Lin, NCMS, Rebar, Photo, XREF-SPILL, IMAGE FILES

LEGEND:

- PIPE
- ▶ FLOW DIRECTION
- ⚡ COMBINATION AIR VALVE
- ◻ REDUCER
- ▭ SUBMERSIBLE PUMP

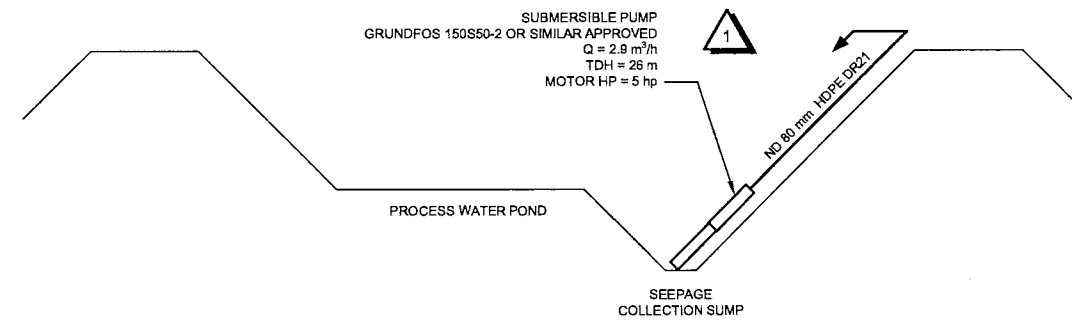

PROCESS WATER POND SEEPAGE COLLECTION AND RECYCLE SYSTEM

FOR INFORMATION ONLY

-- DISCLAIMER -- THIS DRAWING WAS PREPARED BY KNIGHT PIESOLD LTD. FOR THE ACCOUNT OF THE CLIENT LISTED ON THIS DRAWING. THE MATERIAL ON IT REFLECTS KNIGHT PIESOLD'S BEST JUDGMENT IN THE LIGHT OF THE INFORMATION AVAILABLE TO IT AT THE TIME OF PREPARATION. ANY USE WHICH A THIRD PARTY MAKES OF THIS DRAWING, OR ANY RELIANCE ON OR DECISIONS TO BE MADE BASED ON IT, ARE THE RESPONSIBILITY OF SUCH THIRD PARTIES. KNIGHT PIESOLD ACCEPTS NO RESPONSIBILITY FOR DAMAGES, IF ANY, SUFFERED BY THE THIRD PARTY AS A RESULT OF DECISIONS MADE OR ACTIONS BASED ON THIS DRAWING. COPIES RESULTING FROM ELECTRONIC TRANSFER OR REPRODUCTION OF THIS DRAWING ARE UNCONTROLLED AND MAY NOT BE THE MOST RECENT REVISION OF THIS DRAWING.	<i>Knightsold</i> CONSULTING
TINTINA RESOURCES INC.	
BLACK BUTTE COPPER PROJECT	
PROCESS WATER POND SEEPAGE COLLECTION & RECYCLE SYSTEM PIPING AND INSTRUMENTATION DIAGRAM	
P/A NO.	DRAWING NO.
VA101-460/3	C6500
REVISION	
1	

REV	DATE	DESCRIPTION	DESIGNED	DRAWN	REVIEWED	APPROVED
1	28APR'16	VERTICAL PUMP SPECIFICATION REVISED	GIM	RAP	<i>[Signature]</i>	<i>[Signature]</i>
0	16OCT'15	ISSUED FOR MOP APPLICATION	MAP	KJM	<i>[Signature]</i>	<i>[Signature]</i>

DRG. NO.	DESCRIPTION	REV	DATE	DESCRIPTION	DESIGNED	DRAWN	REVIEWED	APPROVED
C6510	PROCESS WATER POND - SEEPAGE COLLECTION & RECYCLE - PLAN & PROFILE							
REVISIONS								
REFERENCE DRAWINGS								

SAVED: M:\110100460\03\A\Acad\DWGS\C6500\C6500_1.dwg, 4/27/2016 3:37:38 PM, RPENG PRINTED: 4/27/2016 3:37:47 PM, layout, RPENG

SAVED: M:\10100460\03\VA101-460\DWG\SEEPAGE\06510C6510_1016/2015 9:25:04 AM . KMILLER PRINTED: 10/16/2015 11:31:18 AM layout_PPRETKOVIC
 AREA FILES: 192 .im .Png .Pmp .Ctp .Sz .Image FILES:

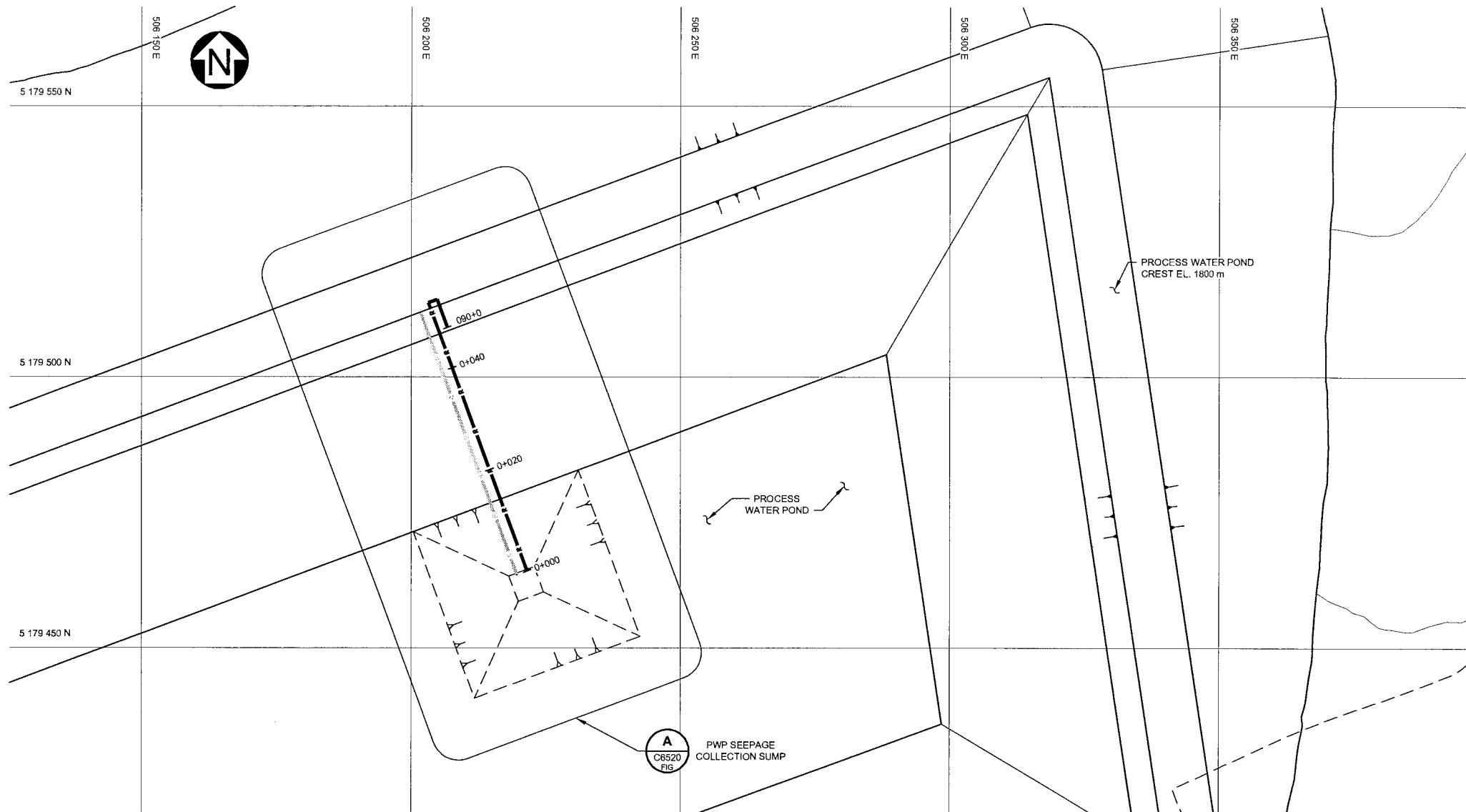

PLAN
SCALE A

LEGEND:

— RECLAIM WATER PIPELINE

NOTES:

- COORDINATE GRID IS UTM NAD83 ZONE 12.
- CONTOUR INTERVAL IS 1 METER.
- DIMENSIONS AND ELEVATIONS ARE IN METERS, UNLESS NOTED OTHERWISE.

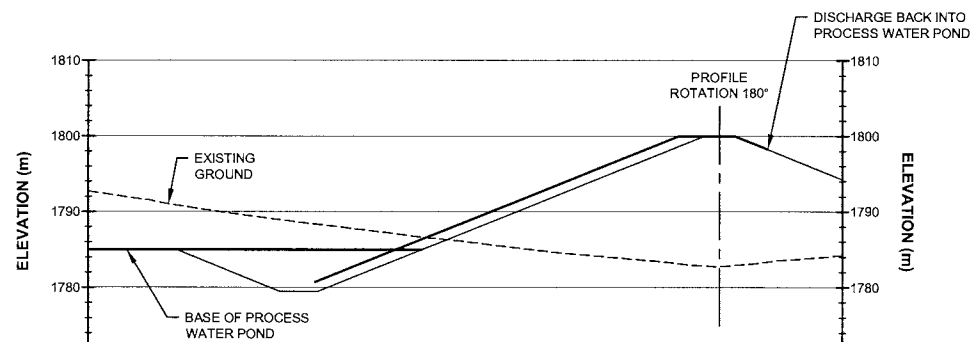

STATION (m)	-0+030	-0+020	0+000	0+020	0+040	0+060	0+070
EXISTING GROUND ELEVATION	1792.72	1791.08	1788.35	1786.01	1783.90	1783.37	1784.21
PIPE INVERT ELEVATION				1788.69	1786.69	1788.25	1784.21
DESIGN PROFILE				SLOPE = 40%		0%	-40%
PIPE DATA	ND 80 mm HDPE DR21 LENGTH = 60 m						

PROFILE
SCALE A

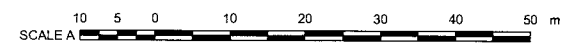

FOR INFORMATION ONLY

DRG. NO.	DESCRIPTION	REV	DATE	DESIGNED	DRAWN	REVIEWED	APPROVED
C6300	SEEPAGE COLLECTION AND PUMPBACK SYSTEM - P&ID						
C6330	SEEPAGE COLLECTION AND PUMPBACK SYSTEM - TYPICAL SECTIONS						

REV	DATE	DESCRIPTION	DESIGNED	DRAWN	REVIEWED	APPROVED
0	16OCT'15	ISSUED FOR MOP APPLICATION				

REV	DATE	DESCRIPTION	DESIGNED	DRAWN	REVIEWED	APPROVED
					K.	K.

DISCLAIMER - THIS DRAWING WAS PREPARED BY KNIGHT PIESOLD LTD. FOR THE ACCOUNT OF THE CLIENT LISTED ON THIS DRAWING. THE MATERIAL ON IT REFLECTS KNIGHT PIESOLD'S BEST JUDGEMENT IN THE LIGHT OF THE INFORMATION AVAILABLE TO IT AT THE TIME OF PREPARATION. ANY USE WHICH A THIRD PARTY MAKES OF THIS DRAWING OR ANY RELIANCE ON OR DECISIONS TO BE MADE BASED ON IT, ARE THE RESPONSIBILITY OF SUCH THIRD PARTY. KNIGHT PIESOLD ACCEPTS NO RESPONSIBILITY FOR DAMAGES, IF ANY, SUFFERED BY THE THIRD PARTY AS A RESULT OF DECISIONS MADE OR ACTIONS BASED ON THIS DRAWING. COPIES RESULTING FROM ELECTRONIC TRANSFER OR REPRODUCTION OF THIS DRAWING ARE UNCONTROLLED AND MAY NOT BE THE MOST RECENT REVISION OF THIS DRAWING.

Knight Piésold
CONSULTING

TINTINA RESOURCES INC.

BLACK BUTTE COPPER PROJECT

**PROCESS WATER POND
SEEPAGE COLLECTION AND
RECYCLE SYSTEM
PLAN AND PROFILE**

P/A NO.	DRAWING NO.	REVISION
VA101-460/3	C6510	0

SAVEN: \\VA101\046\03\1A\Acad\DWG\C6520\C6520.dwg, 10/15/2015 11:37:04 AM, PPETROVIC PRINTED: 10/16/2015 9:29:27 AM, layout, KMILLER

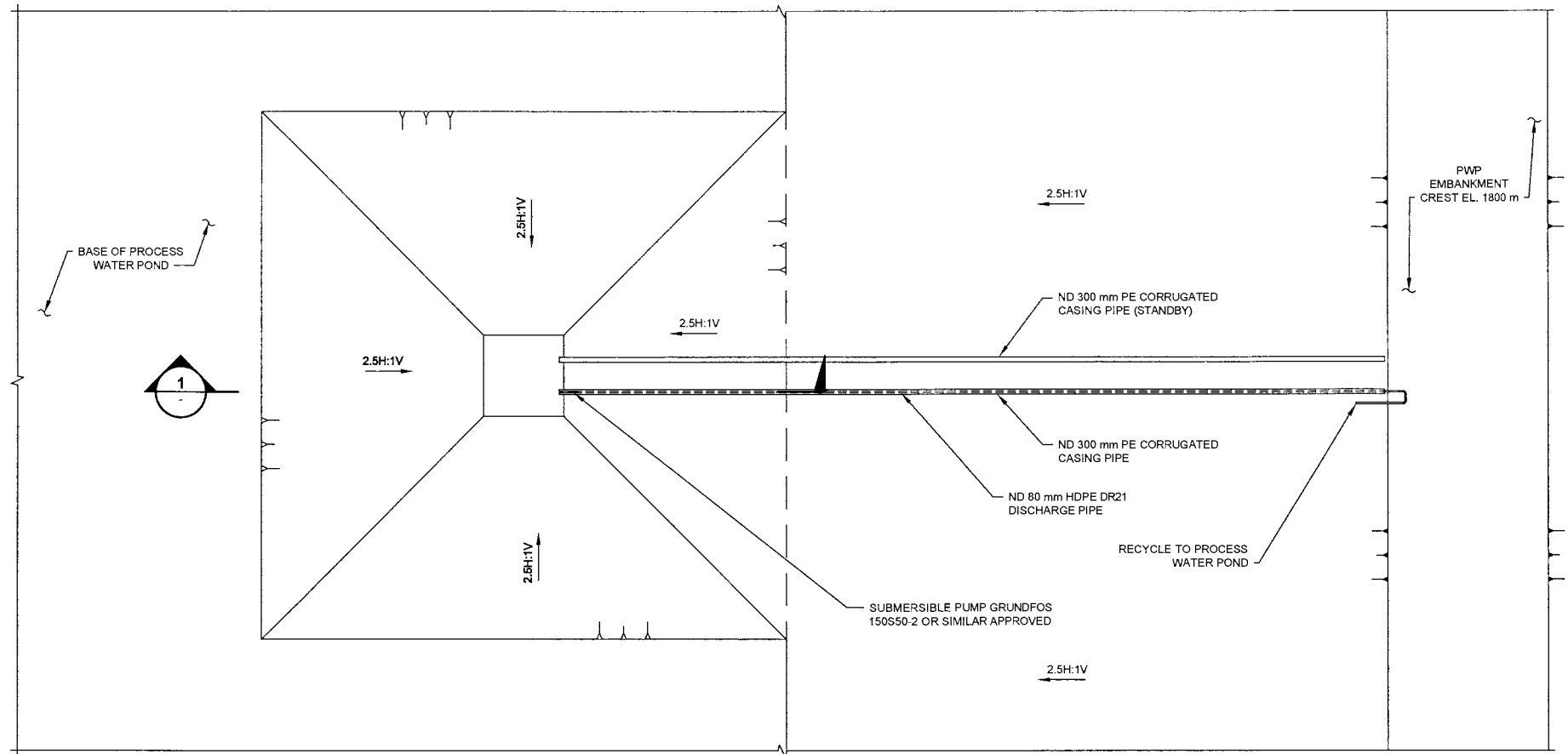

A DETAIL
 C6510 PWP SEEPAGE COLLECTION SUMP
 SCALE A

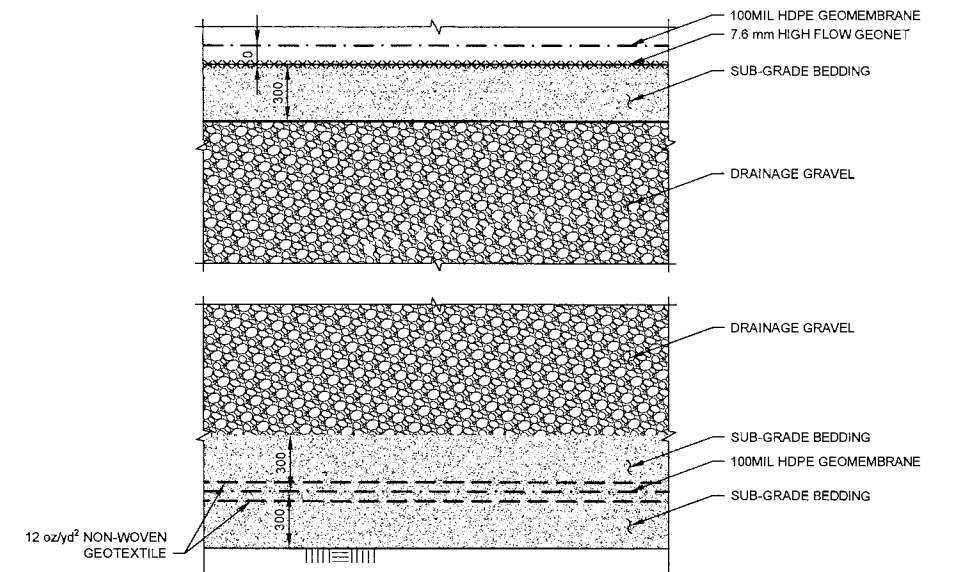

A SECTION
 LINER CONFIGURATION
 NTS

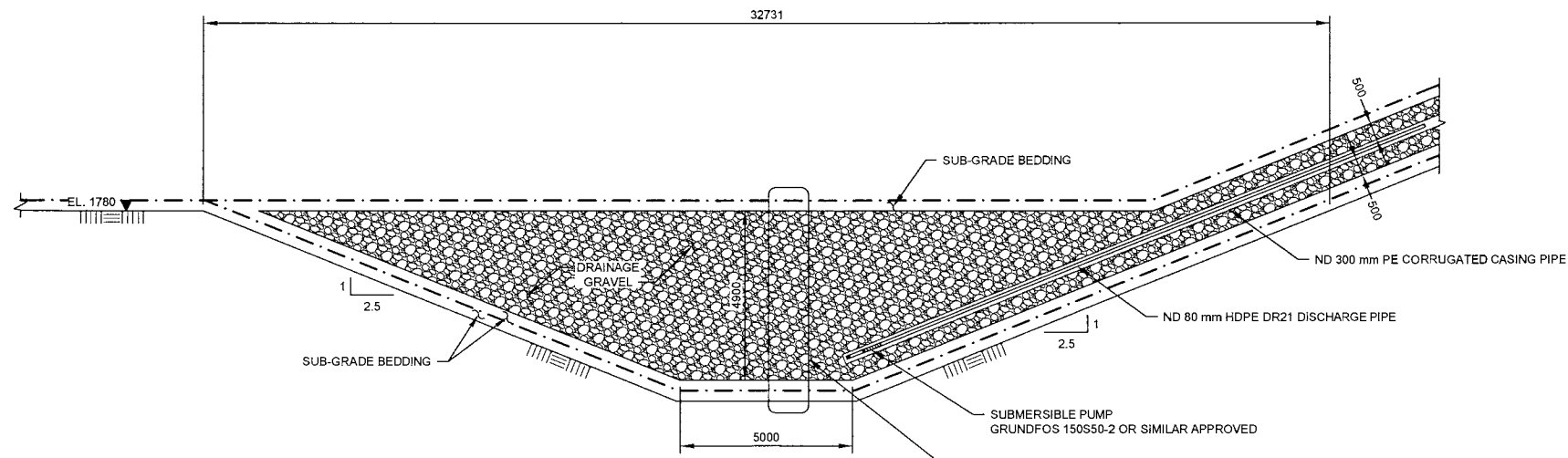

1 SECTION
 PWP SEEPAGE COLLECTION SUMP
 SCALE A

NOTES:

1. DIMENSIONS ARE IN MILLIMETERS AND ELEVATIONS ARE IN METERS, UNLESS NOTED OTHERWISE.

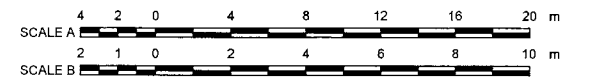

- DISCLAIMER -
 THIS DRAWING WAS PREPARED BY KNIGHT PIESOLD LTD FOR THE ACCOUNT OF THE CLIENT LISTED ON THIS DRAWING. THE MATERIAL ON IT REFLECTS KNIGHT PIESOLD'S BEST JUDGEMENT IN THE LIGHT OF THE INFORMATION AVAILABLE TO IT AT THE TIME OF PREPARATION. ANY USE WHICH A THIRD PARTY MAKES OF THIS DRAWING OR ANY RELIANCE ON OR DECISIONS TO BE MADE BASED ON IT, ARE THE RESPONSIBILITY OF SUCH THIRD PARTIES. KNIGHT PIESOLD ACCEPTS NO RESPONSIBILITY FOR DAMAGES, IF ANY, SUFFERED BY THE THIRD PARTY AS A RESULT OF DECISIONS MADE OR ACTIONS BASED ON THIS DRAWING. COPIES RESULTING FROM ELECTRONIC TRANSFER OR REPRODUCTION OF THIS DRAWING ARE UNCONTROLLED AND MAY NOT BE THE MOST RECENT REVISION OF THIS DRAWING.

Knicht Piésold CONSULTING

TINTINA RESOURCES INC.

BLACK BUTTE COPPER PROJECT

**PROCESS WATER POND
 SEEPAGE COLLECTION AND
 RECYCLE SYSTEM
 TYPICAL SECTIONS**

FOR INFORMATION ONLY

C6220	CTF - WATER MANAGEMENT SYSTEMS - TYPICAL SECTIONS - 1 OF 2					
C6210	CEMENTED TAILINGS FACILITY TO PROCESS WATER POND - PLAN & PROFILE					
DRG. NO.	DESCRIPTION					
REV	DATE	DESCRIPTION	DESIGNED	DRAWN	REVIEWED	APPROVED
REFERENCE DRAWINGS		REVISIONS				

0	16OCT15	ISSUED FOR MOP APPLICATION	RSS	KJM	L.P.	
REV	DATE	DESCRIPTION	DESIGNED	DRAWN	REVIEWED	APPROVED
REVISIONS			REVISIONS			

PIA NO.	DRAWING NO.	REVISION
VA101-460/3	C6520	0

SAVED: M:\11010046003\A\cad\DWGS\C7001\C7001_2_4/27/2017 3:18:04 PM - WLAHODA PRINTED: 4/27/2017 3:24:23 PM, C7001, WLAHODA
 XREF FILES: IMAGE FILES:

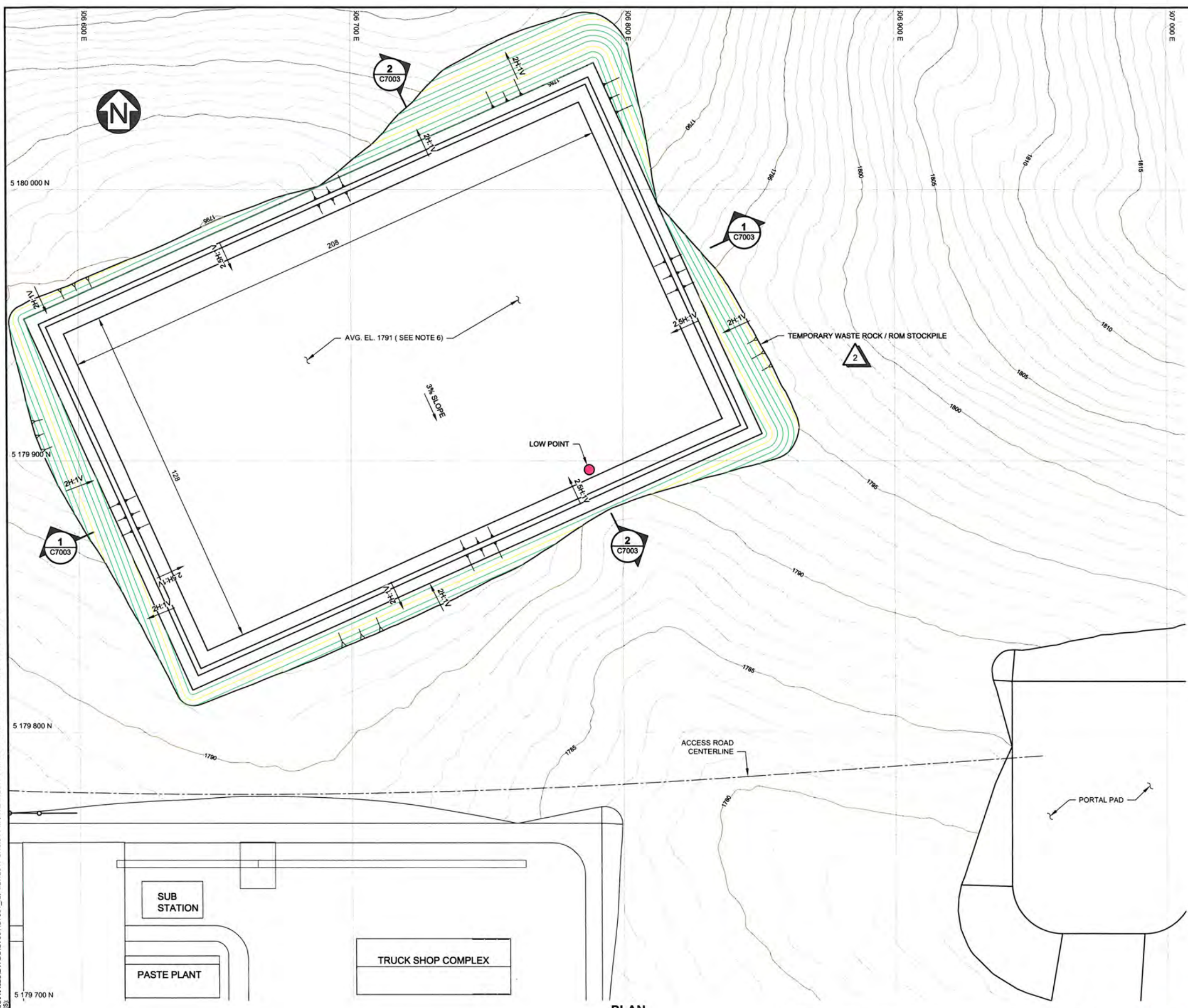

LEGEND:
 EXCAVATION CONTOURS

- NOTES:**
- COORDINATE GRID IS UTM NAD83 ZONE 12.
 - PLAN BASED ON INFORMATION PROVIDED BY TINTINA RESOURCES INC., DATED FEB 03, 2011.
 - CONTOUR INTERVAL IS 1 METER.
 - DIMENSIONS AND ELEVATIONS ARE IN METERS, UNLESS NOTED OTHERWISE.
 - FILL CONTOURS NOT SHOWN FOR CLARITY.
 - PAD ELEVATION RANGES FROM EL. 1793 m TO EL. 1790 m, SLOPING TOWARDS THE SOUTHEAST

FOR INFORMATION ONLY

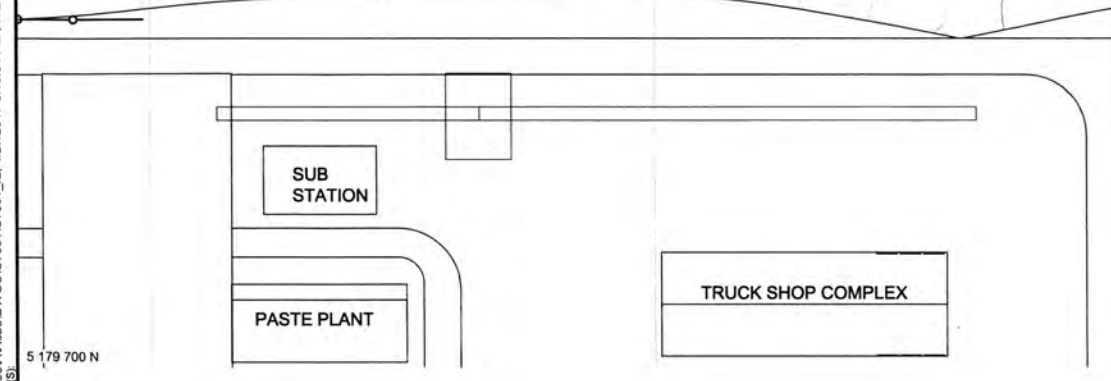

PLAN
SCALE A

DRG. NO.	DESCRIPTION	REV	DATE	DESIGNED	DRAWN	REVIEWED	APPROVED
C7003	TEMPORARY WASTE ROCK STORAGE PAD - SECTIONS AND DETAILS						

REV	DATE	DESCRIPTION	DESIGNED	DRAWN	REVIEWED	APPROVED
2	27APR'17	LABEL ADDED				
1	29APR'16	DIMENSIONS ADDED				
0	15OCT'15	ISSUED FOR MOP APPLICATION				

REV	DATE	DESCRIPTION	DESIGNED	DRAWN	REVIEWED	APPROVED
2	27APR'17	LABEL ADDED	GIM	WAL	K.	K.
1	29APR'16	DIMENSIONS ADDED	GIM	RAP	KDE	KDE
0	15OCT'15	ISSUED FOR MOP APPLICATION	GIM	PP	KDE	KDE

DISCLAIMER - THIS DRAWING WAS PREPARED BY KNIGHT PIESOLD LTD. FOR THE ACCOUNT OF THE CLIENT LISTED ON THIS DRAWING. THE MATERIAL ON IT REFLECTS KNIGHT PIESOLD'S BEST JUDGEMENT IN THE LIGHT OF THE INFORMATION AVAILABLE TO IT AT THE TIME OF PREPARATION. ANY USE WHICH A THIRD PARTY MAKES OF THIS DRAWING, OR ANY RELIANCE ON OR DECISIONS TO BE MADE BASED ON IT, ARE THE RESPONSIBILITY OF SUCH THIRD PARTIES. KNIGHT PIESOLD ACCEPTS NO RESPONSIBILITY FOR DAMAGES, IF ANY, SUFFERED BY THE THIRD PARTY AS A RESULT OF DECISIONS MADE OR ACTIONS BASED ON THIS DRAWING. COPIES RESULTING FROM ELECTRONIC TRANSFER OR REPRODUCTION OF THIS DRAWING ARE UNCONTROLLED AND MAY NOT BE THE MOST RECENT REVISION OF THIS DRAWING.

Knicht Piésold CONSULTING		
TINTINA RESOURCES INC.		
BLACK BUTTE COPPER PROJECT		
TEMPORARY WASTE ROCK STORAGE PAD GRADING PLAN		
PIA NO.	DRAWING NO.	REVISION
VA101-460/3	C7001	2

SAVED: M:\110146003\VA101460\DWGS\C7002\C7002_1_1_4272017 3:38:39 PM - WLAHODA PRINTED: 4/27/2017 3:46:28 PM - C7002 - WLAHODA
 XREF FILES: IMAGE FILES

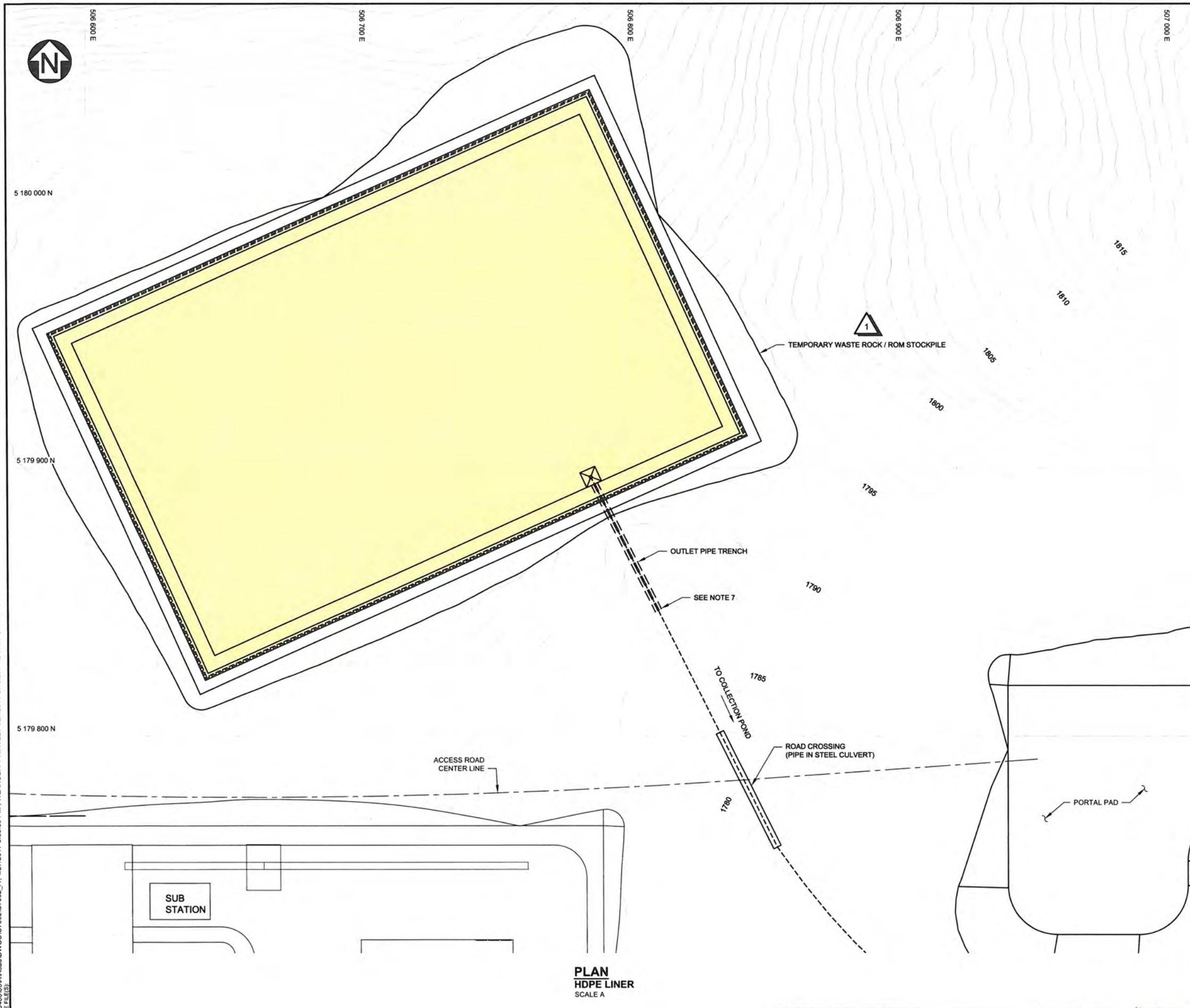

LEGEND:

- HDPE LINER
- 8" N12 PE OUTLET PIPE

NOTES:

1. COORDINATE GRID IS UTM NAD83 ZONE 12.
2. PLAN BASED ON INFORMATION PROVIDED BY TINTINA RESOURCES INC., DATED FEB 03, 2011.
3. CONTOUR INTERVAL IS 1 METER.
4. DIMENSIONS AND ELEVATIONS ARE IN METERS, UNLESS NOTED OTHERWISE.
5. HDPE LINER CONFIGURATION SHOWN ON DRG. C7003.
6. PORTAL PAD, SUB STATION PASTE PLANT, AND TRUCK SHOP COMPLEX DESIGNED BY TETRA TECH.
7. OUTLET PIPE TRENCH WILL BE EXCAVATED AT A 0.5% GRADE. OUTLET PIPE WILL BE PLACED ON SURFACE AFTER DAYLIGHT POINT AND SECURED IN PLACE WITH EARTH FILL BERMS.

FOR INFORMATION ONLY



- DISCLAIMER -
 THIS DRAWING WAS PREPARED BY KNIGHT PIESOLD LTD. FOR THE ACCOUNT OF THE CLIENT LISTED ON THIS DRAWING. THE MATERIAL ON IT REFLECTS KNIGHT PIESOLD'S BEST JUDGMENT IN THE LIGHT OF THE INFORMATION AVAILABLE TO IT AT THE TIME OF PREPARATION. ANY USE WHICH A THIRD PARTY MAKES OF THIS DRAWING, OR ANY RELIANCE ON OR DECISIONS TO BE MADE BASED ON IT, ARE THE RESPONSIBILITY OF SUCH THIRD PARTIES. KNIGHT PIESOLD ACCEPTS NO RESPONSIBILITY FOR DAMAGES, IF ANY, SUFFERED BY THE THIRD PARTY AS A RESULT OF DECISIONS MADE OR ACTIONS BASED ON THIS DRAWING. COPIES RESULTING FROM ELECTRONIC TRANSFER OR REPRODUCTION OF THIS DRAWING ARE UNCONTROLLED AND MAY NOT BE THE MOST RECENT REVISION OF THIS DRAWING.

Knicht Piesold CONSULTING		
TINTINA RESOURCES INC.		
BLACK BUTTE COPPER PROJECT		
TEMPORARY WASTE ROCK STORAGE PAD HDPE LINER AND SEEPAGE COLLECTION SYSTEM LAYOUT PLAN		
P/A NO.	DRAWING NO.	REVISION
VA101-460/3	C7002	1

DRG. NO.	DESCRIPTION	REV	DATE	DESIGNED	DRAWN	REVIEWED	APPROVED
	REFERENCE DRAWINGS						
	REVISIONS						

REV	DATE	DESCRIPTION	DESIGNED	DRAWN	REVIEWED	APPROVED
1	27APR'17	LABEL ADDED	GIM	WAL	KDE	KDE
0	16OCT'15	ISSUED FOR MOP APPLICATION	GIM	PP	KDE	KDE
		REVISIONS				

**PLAN
HDPE LINER
SCALE A**

SAVED: M:\101\10460\03\A\cadd\DWGS\C7003\C7003.dwg, 10/16/2015 9:39:40 AM, KMILLER PRINTED: 10/16/2015 9:44:24 AM, C7003, KMILLER
 SHEET 159 OF 159 (TEMP IMAGE FILES)

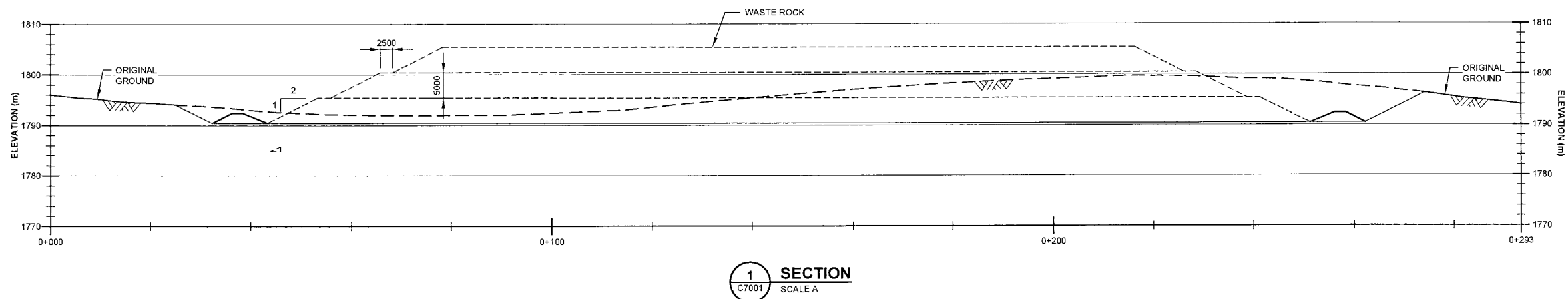

1 SECTION
C7001 SCALE A

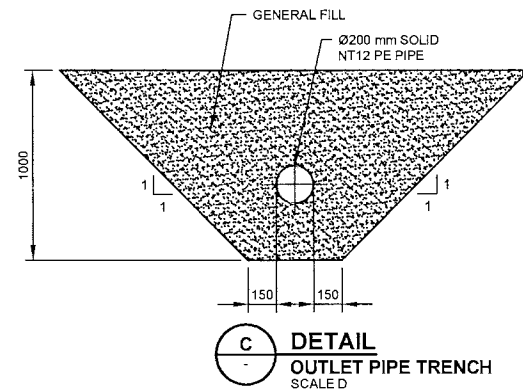

C DETAIL
OUTLET PIPE TRENCH
SCALE D

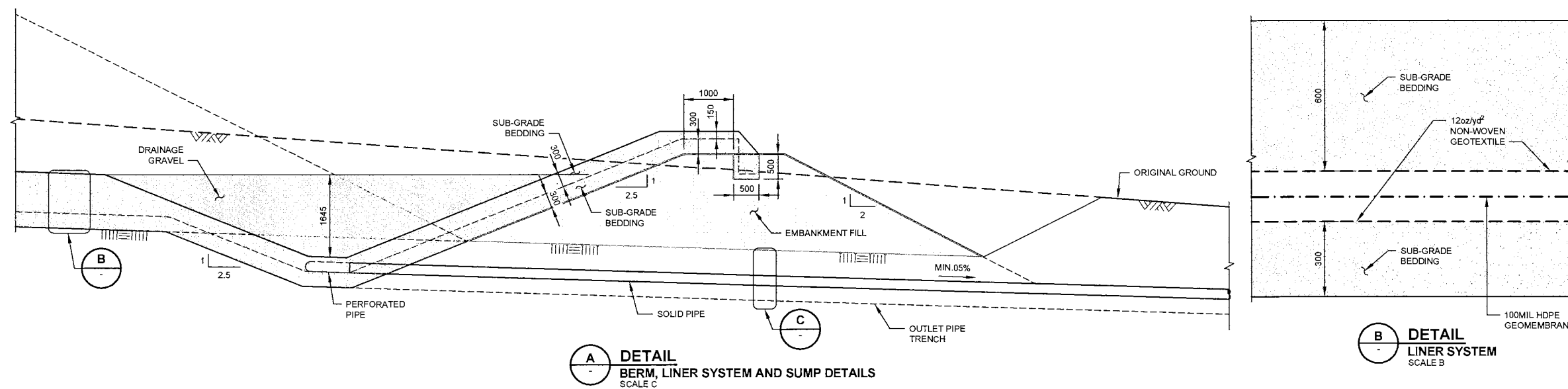

A DETAIL
BERM, LINER SYSTEM AND SUMP DETAILS
SCALE C

B DETAIL
LINER SYSTEM
SCALE B

- NOTES:**
1. OUTLET PIPE TRENCH GRADED AT 0.5% UNTIL IT DAYLIGHTS AT SURFACE.
 2. OUTLET PIPE ON SURFACE TO BE SECURED IN PLACE USING EARTH-FILL BERMS.
 3. ALL DIMENSIONS ARE IN MILLIMETERS AND ELEVATIONS ARE IN METERS, UNLESS NOTED OTHERWISE.

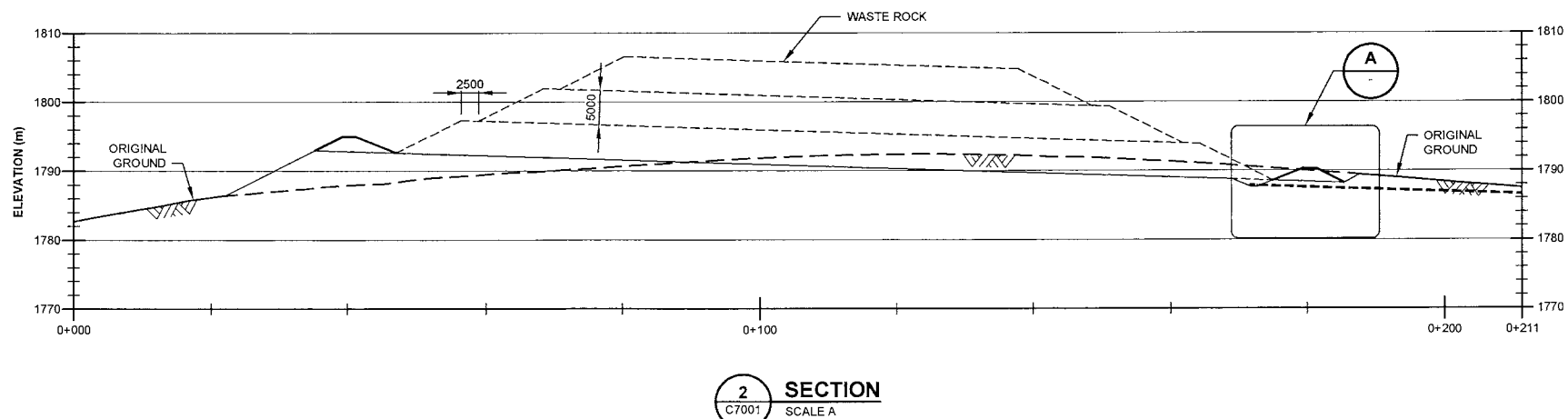

2 SECTION
C7001 SCALE A

FOR INFORMATION ONLY

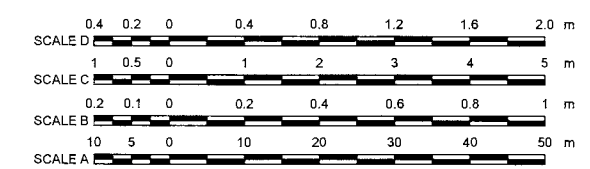

DISCLAIMER
 THIS DRAWING WAS PREPARED BY KNIGHT PIESOLD LTD. FOR THE ACCOUNT OF THE CLIENT LISTED ON THIS DRAWING. THE MATERIAL ON IT REFLECTS KNIGHT PIESOLD'S BEST JUDGEMENT IN THE LIGHT OF THE INFORMATION AVAILABLE TO IT AT THE TIME OF PREPARATION. ANY USE WHICH A THIRD PARTY MAKES OF THIS DRAWING, OR ANY RELIANCE ON OR DECISIONS TO BE MADE BASED ON IT, ARE THE RESPONSIBILITY OF SUCH THIRD PARTIES. KNIGHT PIESOLD ACCEPTS NO RESPONSIBILITY FOR DAMAGES, IF ANY, SUFFERED BY THE THIRD PARTY AS A RESULT OF DECISIONS MADE OR ACTIONS BASED ON THIS DRAWING. COPIES RESULTING FROM ELECTRONIC TRANSFER OR REPRODUCTION OF THIS DRAWING ARE UNCONTROLLED AND MAY NOT BE THE MOST RECENT REVISION OF THIS DRAWING.

Knights Piesold
CONSULTING

TINTINA RESOURCES INC.

BLACK BUTTE COPPER PROJECT

TEMPORARY WASTE ROCK STORAGE PAD SECTIONS AND DETAILS

C7001	TEMPORARY WASTE ROCK STORAGE PAD - GRADING PLAN	0	16OCT'15	ISSUED FOR MOP APPLICATION	GIM	PP	K.	K.
DRG. NO.	DESCRIPTION	REV	DATE	DESCRIPTION	DESIGNED	DRAWN	REVIEWED	APPROVED
	REFERENCE DRAWINGS			REVISIONS				
				REVISIONS				

P/A NO.	DRAWING NO.	REVISION
VA101-460/3	C7003	0

SAVED: M:\11004603\A\Acad\DWG\C8001\C8001_4.dwg 6/30/2017 11:26:47 AM, MCOLTTS PRINTED: 6/30/2017 11:41:24 AM, C8001, MCOLTTS
 (REF FILES) (IMAGE FILES)

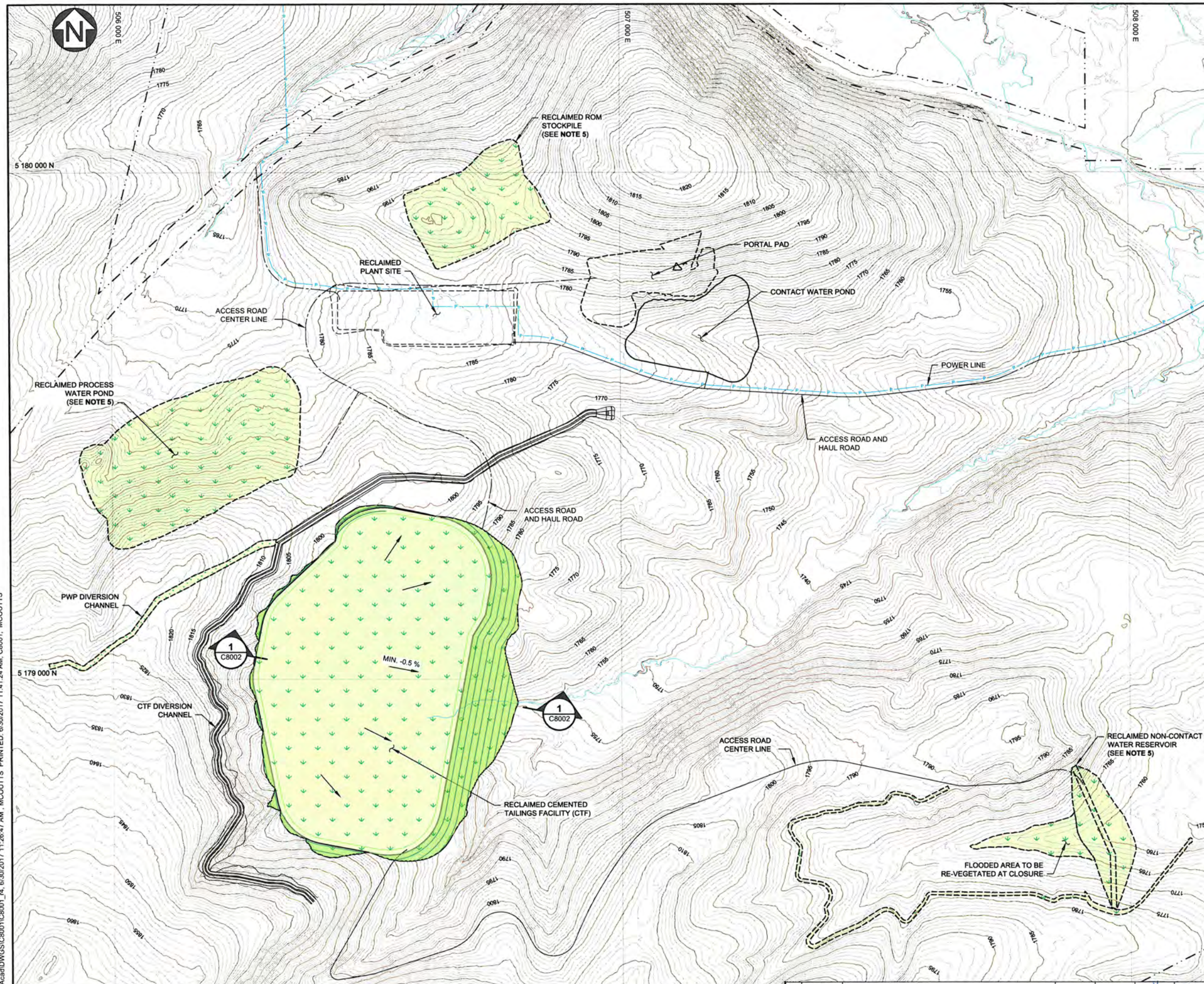

LEGEND:

RECLAIMED AREA

NOTES:

1. COORDINATE GRID IS UTM NAD83 ZONE 12.
2. PLAN BASED ON INFORMATION PROVIDED BY TINTINA RESOURCES INC., DATED FEB 03, 2011.
3. CONTOUR INTERVAL IS 1 METER.
4. DIMENSIONS AND ELEVATIONS ARE IN METERS, UNLESS NOTED OTHERWISE.
5. PWP, NCWR, AND ROM STOCKPILE AREAS WILL BE CONTOURED AT RECLAMATION TO APPROXIMATE THE ORIGINAL TOPOGRAPHY.
6. PLANT SITE, PORTAL PAD, CONTACT WATER POND, AND ACCESS ROADS CLOSURE PLAN WILL BE DEVELOPED BY TETRA TECH.
7. THE CTF DIVERSION CHANNEL PERIMETERS AND OUT-SLOPING FILL WILL BE REVEGETATED FOLLOWING CONSTRUCTION AND WILL REMAIN IN CLOSURE.



FOR INFORMATION ONLY



PLAN
SCALE A

REV	DATE	DESCRIPTION	DESIGNED	DRAWN	REVIEWED	APPROVED
4	30JUN'17	POWERLINES UPDATED	GIM	MJC	KDE	KDE
3	20APR'17	NOTES REVISED	GIM	RAF	KDE	KDE
2	06MAR'17	NCWR SPILLWAY & DIV. CHANNEL RECLAIM AREA ADDED	GIM	WAL	KDE	KDE
1	29APR'16	MINOR REVISIONS	GIM	RAP	KDE	KDE
0	16OCT'15	ISSUED FOR MOP APPLICATION	GIM	PP	KJB	KJB

DISCLAIMER - THIS DRAWING WAS PREPARED BY KNIGHT PIESOLD LTD. FOR THE ACCOUNT OF THE CLIENT LISTED ON THIS DRAWING. THE MATERIAL ON IT REFLECTS KNIGHT PIESOLD'S BEST JUDGEMENT IN THE LIGHT OF THE INFORMATION AVAILABLE TO IT AT THE TIME OF PREPARATION. ANY USE WHICH A THIRD PARTY MAKES OF THIS DRAWING OR ANY RELIANCE ON OR DECISIONS TO BE MADE BASED ON IT, ARE THE RESPONSIBILITY OF SUCH THIRD PARTIES. KNIGHT PIESOLD ACCEPTS NO RESPONSIBILITY FOR DAMAGES, IF ANY, SUFFERED BY THE THIRD PARTY AS A RESULT OF DECISIONS MADE OR ACTIONS BASED ON THIS DRAWING. COPIES RESULTING FROM ELECTRONIC TRANSFER OR REPRODUCTION OF THIS DRAWING ARE UNCONTROLLED AND MAY NOT BE THE MOST RECENT REVISION OF THIS DRAWING.

Knight Piesold
CONSULTING

TINTINA RESOURCES INC.

BLACK BUTTE COPPER PROJECT

**CTF, PWP, NCWR AND ROM STOCKPILE
POST CLOSURE TOPOGRAPHIC MAP**

DRG. NO.	DESCRIPTION	REV	DATE	DESCRIPTION	DESIGNED	DRAWN	REVIEWED	APPROVED
C8002	CTF RECLAMATION - SECTION							

REV	DATE	DESCRIPTION	DESIGNED	DRAWN	REVIEWED	APPROVED

REV	DATE	DESCRIPTION	DESIGNED	DRAWN	REVIEWED	APPROVED

PIA NO.	DRAWING NO.	REVISION
VA101-460/3	C8001	4

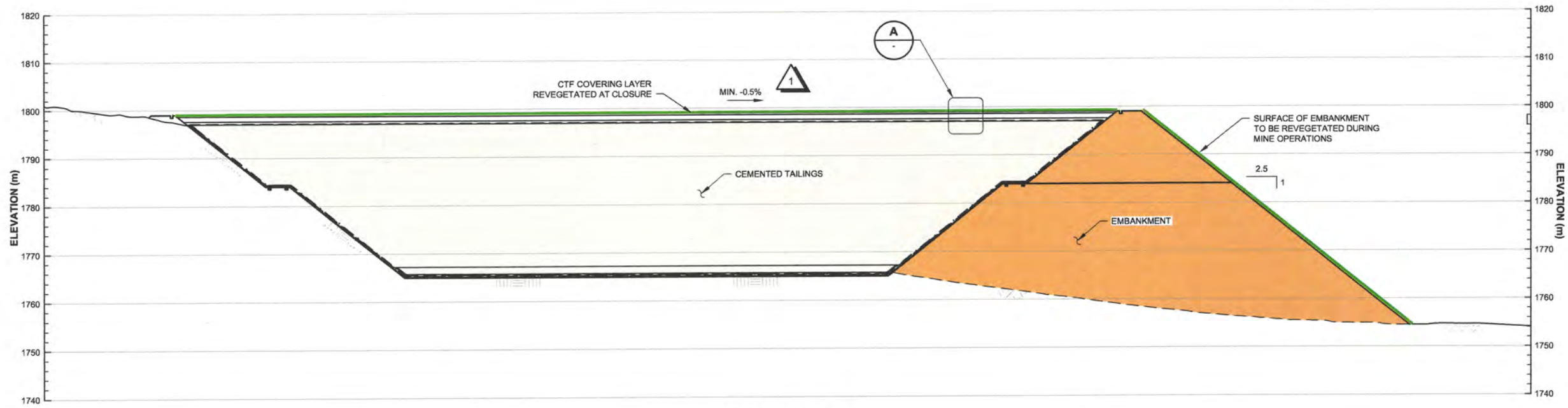

1 SECTION
C8001
HORIZONTAL: SCALE A
VERTICAL: SCALE B

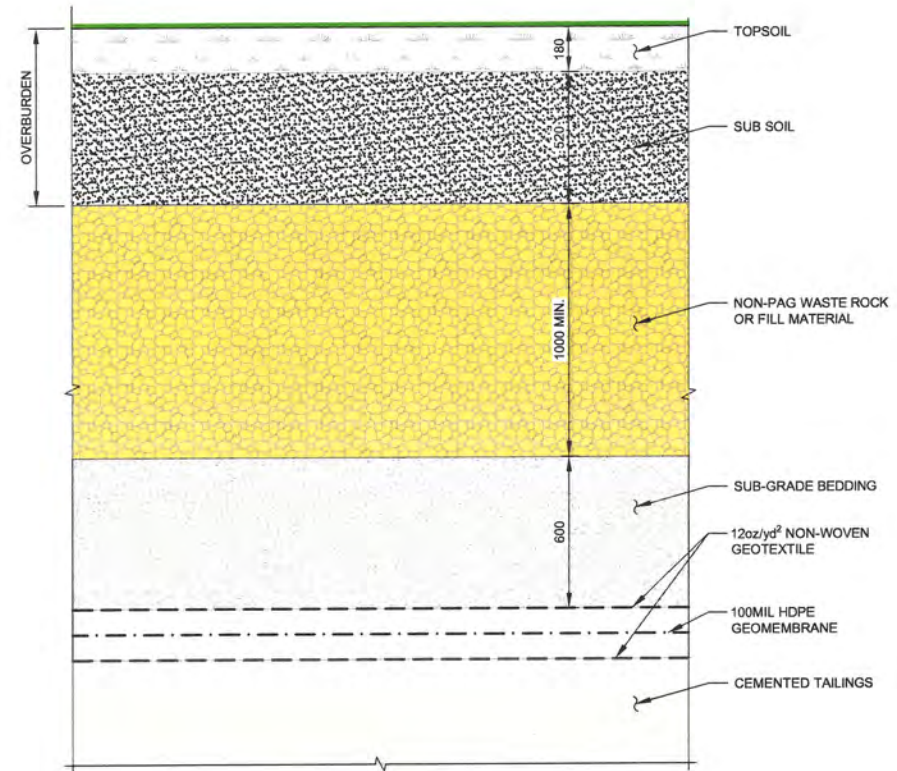

A DETAIL
CTF CLOSURE COVER DETAILS
SCALE C

NOTES:

1. TAILINGS SURFACE WILL BE LEVELED USING SUB-GRADE BEDDING AS NEEDED.
2. DIMENSIONS ARE IN MILLIMETERS AND ELEVATIONS ARE IN METERS, UNLESS NOTED OTHERWISE.

FOR INFORMATION ONLY

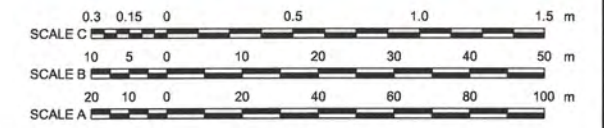

DISCLAIMER
THIS DRAWING WAS PREPARED BY KNIGHT PIESOLD LTD. FOR THE ACCOUNT OF THE CLIENT LISTED ON THIS DRAWING. THE MATERIAL ON IT REFLECTS KNIGHT PIESOLD'S BEST JUDGEMENT IN THE LIGHT OF THE INFORMATION AVAILABLE TO IT AT THE TIME OF PREPARATION. ANY USE WHICH A THIRD PARTY MAKES OF THIS DRAWING OR ANY RELIANCE ON OR DECISIONS TO BE MADE BASED ON IT, ARE THE RESPONSIBILITY OF SUCH THIRD PARTIES. KNIGHT PIESOLD ACCEPTS NO RESPONSIBILITY FOR DAMAGES, IF ANY, SUFFERED BY THE THIRD PARTY AS A RESULT OF DECISIONS MADE OR ACTIONS BASED ON THIS DRAWING. COPIES RESULTING FROM ELECTRONIC TRANSFER OR REPRODUCTION OF THIS DRAWING ARE UNCONTROLLED AND MAY NOT BE THE MOST RECENT REVISION OF THIS DRAWING.

Knight Piesold
CONSULTING

TINTINA RESOURCES INC.

BLACK BUTTE COPPER PROJECT

CTF RECLAMATION SECTION

DRG. NO.	DESCRIPTION	REV	DATE	DESIGNED	DRAWN	REVIEWED	APPROVED	REV	DATE	DESCRIPTION	DESIGNED	DRAWN	REVIEWED	APPROVED
C8001	CTF, PWP, NCWR AND ROM STOCKPILE - POST CLOSURE TOPOGRAPHIC MAP							1	29APR'16	CTF SLOPE ADDED	GIM	RAP	KJB	KJB
								0	16OCT'15	ISSUED FOR MOP APPLICATION	GIM	PP	KJB	KJB
REFERENCE DRAWINGS				REVISIONS				REVISIONS						

PIA NO.	DRAWING NO.	REVISION
VA101-460/3	C8002	1

APPENDIX C

TAILINGS PHYSICAL TESTING RESULTS

(Pages C-1 to C-7)

UNDRAINED SETTLING TEST

Project No.
VA101-460/03

Project: Black Butte Copper Sample ID: LCT Tailings Virgin Material Test Date: 9/3-9/10/2015
 Target Solids: 79% Actual Solids: 79.4% Tested By: JK/DB

Initial Parameters

a. Cylinder (Tare) Weight =	184	g	d. Moisture Content (from drying test) =	26.0	%
b. Initial Slurry Volume =	440	ml	e. Initial Slurry Bulk Density [(c-a)/b] =	2.37	g/cm ³
c. Tare + Initial Slurry Weight =	1228	g	f. Weight of Water [(c-a)/(1+ 1/(d/100))] =	216	g
Time of Readings 03-Sep-15 10:24 AM			g. Weight of Solids [(c-a)/(1+ d/100)] =	829	g

On-going Readings

	Date of Reading	Time of Reading	A. Total Cylinder Weight (g)	B. Total Cylinder Volume (ml)	C. Settled Slurry Volume (ml)	D. Water Recovery [(B-C)/f] (%)	E. Volume Reduction of Solids [1-C/b] (%)	F. Slurry Bulk Density [(A-a-(B-C))/C] (g/cm ³)	G. Slurry Dry Density [g/C] (g/cm ³)	H. Moisture Content [(f-(B-C))/g] (%)
1	03-Sep-15	10:41 AM	1228	440	440	0	0	2.37	1.88	26.01
2	03-Sep-15	10:59 AM	1228	440	440	0	0	2.37	1.88	26.01
3	03-Sep-15	11:29 AM	1228	440	440	0	0	2.37	1.88	26.01
4	03-Sep-15	12:25 PM	1228	440	440	0	0	2.37	1.88	26.01
5	03-Sep-15	01:31 PM	1228	440	435	2	1	2.39	1.91	25.40
6	03-Sep-15	02:36 PM	1228	440	430	5	2	2.41	1.93	24.80
7	03-Sep-15	03:22 PM	1228	440	430	5	2	2.41	1.93	24.80
8	03-Sep-15	04:26 PM	1228	440	430	5	2	2.40	1.93	24.80
9	04-Sep-15	09:03 AM	1228	440	415	12	6	2.46	2.00	22.99
10	04-Sep-15	03:55 PM	1228	440	414	12	6	2.46	2.00	22.87
11	05-Sep-15	11:30 AM	1228	440	414	12	6	2.46	2.00	22.87
12	08-Sep-15	08:39 AM	1227	440	414	12	6	2.46	2.00	22.87
13	10-Sep-15	08:21 AM	1227	440	414	12	6	2.46	2.00	22.87

**DRAINED SETTLING TEST AND
FALLING HEAD PERMEABILITY TEST**

Project No.
VA 101-460/03

Project: Black Butte Copper Sample ID: LCT Tailings Virgin Material Test Date: 9/3-9/16/2015
Target Solids: 79% Actual Solids: 78.3% Tested By: JK/JB

Initial Parameters

a. Cylinder (Tare) Weight =	186	g	d. Moisture Content (from drying test) =	27.7	%
b. Initial Slurry Volume =	525	ml	e. Initial Slurry Bulk Density [(c-a)/b] =	2.32	g/cm ³
c. Tare + Initial Slurry Weight =	1405	g	f. Weight of Water [(c-a)/(1+ 1/(d/100))] =	265	g
Time of Readings	03-Sep-15	10:21 AM	g. Weight of Solids [(c-a)/(1+ d/100)] =	955	g

On-going Readings

			A.	B.	C.	D.	E.	F.	G.	H.
	Date of Reading	Time of Reading	Total Cylinder Weight (before decant) (g)	Total Cylinder Volume (ml)	Settled Slurry Volume (ml)	Water Volume [B-C] (ml)	Drainage Volume Collected (ml)	Decanted Water Volume (ml)	Slurry Bulk Density [(A-a-(B-C))/C] (g/cm ³)	Slurry Dry Density [g/C] (g/cm ³)
1	03-Sep-15	10:40 AM	1401	525	520	5	4	0	2.33	1.84
2	03-Sep-15	01:34 PM	1389	510	500	10	16	2	2.39	1.91
3	03-Sep-15	04:20 PM	1382	495	488	7	21	5	2.44	1.96
4	04-Sep-15	08:55 AM	1364	480	480	0	33	0	2.46	1.99
5	04-Sep-15	03:54 PM	1362	478	478	0	36	0	2.46	2.00
6	05-Sep-15	11:30 AM	1360	478	478	0	37	0	2.46	2.00

Falling Head Permeability Test

	Data Readings, T _i (hours)	Initial Water Height, h _i (cm)	Initial Solids Height, H _i (cm)	Finishing Time, T _f (hours)	Final Water Height, h _f (cm)	Final Solids Height, H _f (cm)	Drainage Collected (ml)	Elapsed Time, T (hours)	Ave. Solids Thickness, H (cm)	Permeability k H/3600T*ln(h _i /h _f) (cm/sec)
1	0.00	34.9	16.1	0.00	32.8	16.1	46	31.37	16.1	8.8E-06
2	0.00	32.8	16.1	0.00	31.9	16.1	24	16.33	16.1	7.6E-06
3	0.00	31.9	16.1	0.00	30.4	16.1	34	23.63	16.1	9.1E-06
4	0.00	30.4	16.1	0.00	26.0	16.1	95	72.50	16.1	9.6E-06
5	0.00	26.0	16.1	0.00	24.9	16.1	29	23.62	16.1	8.2E-06
									AVG.	8.7E-06

Project: Black Butte Copper
Target Solids : 79%

Sample ID: LCT Tailings Virgin Material
Actual Solids 80.5%

Test Date: 9/3-9/30/15
Tested By: JK/JB

Initial Parameters for Settling and Drying Test

a. Beaker (Tare) Weight = 408.97 g
b. Initial Slurry Volume = 440 cm³
c. Tare + Initial Slurry Weight = 1407.6 g
Time of Readings 10:22 AM

d. Moisture Content (from drying test) = 24.2 %
e. Initial Slurry Bulk Density [(c-a)/b] = 2.27 g/cm³
f. Weight of Water [(c-a)/(1+ 1/(d/100))] = 195 g
g. Weight of Solids [(c-a)/(1+ d/100)] = 804 g
h. Tailings Solids Specific Gravity = 3.778
i. Solids Volume [g/h] = 212.8 cm³

Initial Parameters for Evaporation Control

x. Beaker Tare Weight = 413 g
y. Initial Weight of Beaker = 1472 g
z. Beaker Cross-Sectional Area = 81.39 cm²

On-going Readings

	Date of Reading	Time of Reading											Comments	Evaporation Control		
			A. Total Remaining Weight (g)	B. Total Remaining Volume (cm ³)	C. Settled Slurry Volume (cm ³)	D. Decanted Water Volume (if any) (cm ³)	E. Shrinkage Crack Volume (estimated) (cm ³)	F. Net. Slurry Volume [C-E] (cm ³)	G. Volume Reduction [(b-F)/b] (%)	H. Slurry Dry Density [g/F] (g/cm ³)	I. Moisture Content [(A-a)/g]-1 (%)	J. Saturation (A-a-g)/(B-i) (%)		Total Weight After Decant (g)	Decanted Weight (if any) (g)	Evap. (mm)
1	03-Sep-15	10:38 AM	1407	435.0	405.0	0.7		405.0	8.0	1.98	24.2	100.0	Water Decanted	1471	0	0
2	03-Sep-15	1:33 PM	1404	425.0	400.0	9.4		400.0	9.1	2.01	23.8	100.0	Water Decanted	1468	0	1
3	03-Sep-15	4:18 PM	1392	405.0	395.0	8.5		395.0	10.2	2.03	22.3	98.4	Water Decanted	1464	0	1
4	04-Sep-15	8:53 AM	1369	390.0	390.0	0.0		390.0	11.4	2.06	19.4	88.1	no free water	1445	0	3
5	04-Sep-15	3:53 PM	1365	386.0	386.0	0.0		386.0	12.3	2.08	18.9	87.7	no free water	1439	0	4
6	05-Sep-15	11:30 AM	1349		384.8		13.3	371.5	15.6	2.16	17.0	86.1	Specimen pulling from sides	1419	0	6
7	08-Sep-15	8:25 AM	1297		364.7		31.1	333.6	24.2	2.41	10.5	69.8	Specimen measured	1347	0	15
8	09-Sep-15	4:00 PM	1280		364.7		32.5	332.2	24.5	2.42	8.4	56.3	Specimen measured	1313	0	19
9	10-Sep-15	8:16 AM	1274		364.7		33.1	331.6	24.6	2.42	7.6	51.2	Specimen measured	1292	0	22
10	11-Sep-15	7:57 AM	1266		364.7		33.1	331.6	24.6	2.42	6.6	44.8	Specimen measured	1263	0	26
11	14-Sep-15	8:30 AM	1255		364.7		34.5	330.2	25.0	2.43	5.3	36.2	Specimen measured	1185	0	35
12	15-Sep-15	8:02 AM	1252		361.4		32.8	328.5	25.3	2.45	4.9	34.2	Specimen measured	1156	0	39
13	17-Sep-15	7:57 AM	1248		361.4		32.8	328.5	25.3	2.45	4.4	30.8	Specimen measured	1101	0	46
14	18-Sep-15	10:02 AM	1247		361.4		32.8	328.5	25.3	2.45	4.3	29.6	Specimen measured	1073	0	49
15	22-Sep-15	8:36 AM	1242		361.4		32.8	328.5	25.3	2.45	3.7	25.5	Specimen measured	968	0	62
16	25-Sep-15	9:55 AM	1240		361.4		32.8	328.5	25.3	2.45	3.3	23.1	Specimen measured	898	0	70
17	30-Sep-15	4:00 PM	1236		361.4		32.8	328.5	25.3	2.45	2.9	20.0	Specimen measured	783	0	85

S:\Tailings settling and Consol data\2015\Black Butte\ [L2015-061 Black Butte LCT Settling Rev 0.xls]Graphs

Notes:

TABLE 1.0

**Black Butte Copper
VA101-460/03
LCT Tailings Virgin Material**

**SUMMARY OF TAILINGS SEDIMENTATION TEST RESULTS
79%**

Undrained Settling Test				Drained Settling Test					Settling and Drying Test			Additional Water Recovered in Drained Test (%)
Solids Content (%)	Slurry Dry Density (g/cm³)	Total Water Recovery (%)	Portion of Initial Water Retained in Tailings prior to Onset of Evaporation (%)	Solids Content (%)	Slurry Dry Density (g/cm³)	Total Water Recovery (%)	Portion of Initial Water Retained in Tailings prior to Onset of Evaporation (%)	Average Permeability (cm/sec)	Solids Content (%)	Slurry Dry Density (g/cm³)	Total Evaporation (mm)	
79.4	2.00	12.1	87.9	78.3	2.00	16.9	83.1	8.7E-06	80.5	2.45	84.6	4.9

FIGURE 1.1

Black Butte Copper
VA101-460/03
LCT Tailings Virgin Material

TAILINGS DEPOSITION METHOD VS. DRY DENSITY
79.0%

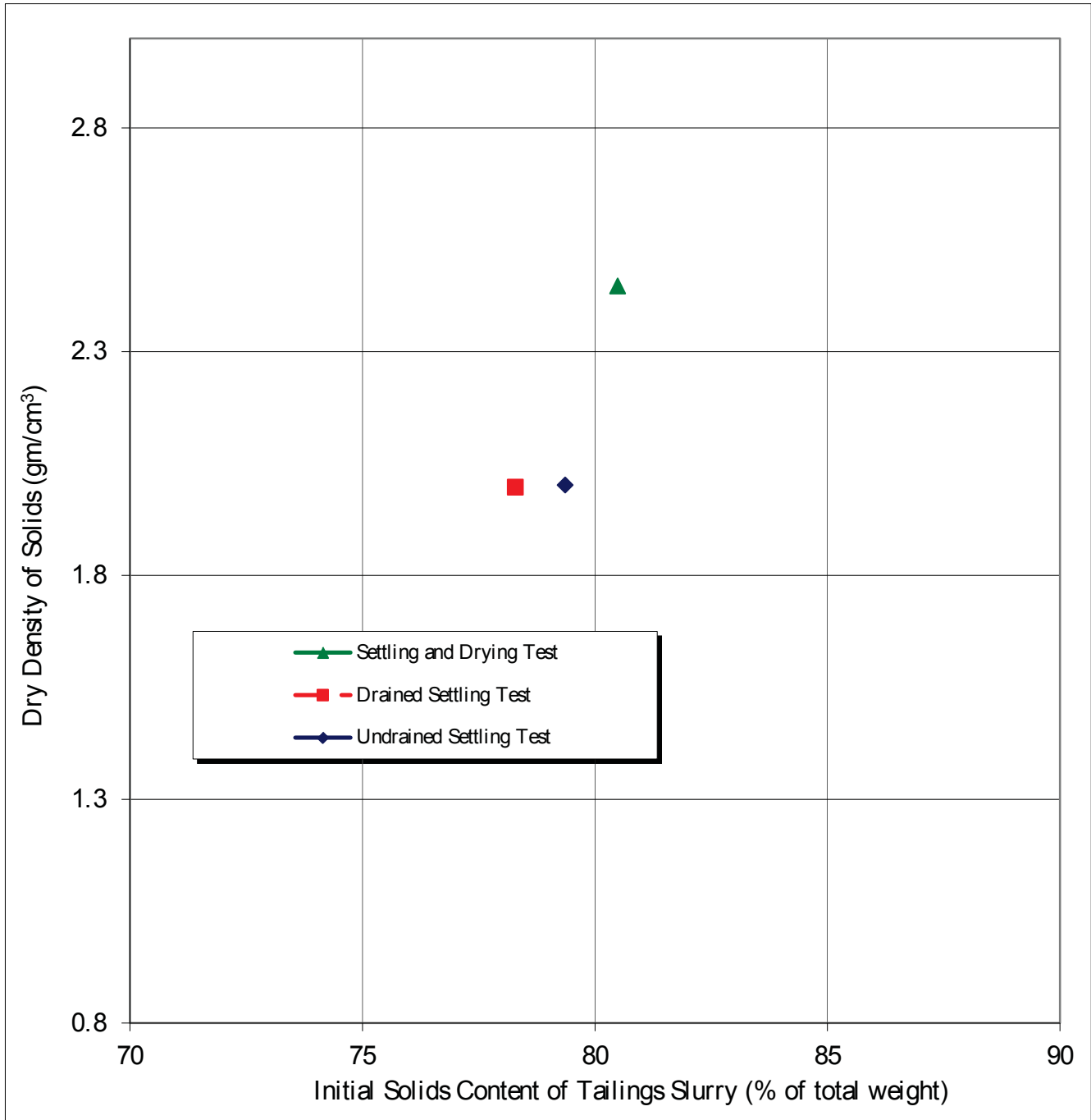

FIGURE 1.2

Black Butte Copper
VA101-460/03
LCT Tailings Virgin Material

TAILINGS DEPOSITION METHOD VS. WATER RECOVERY
79%

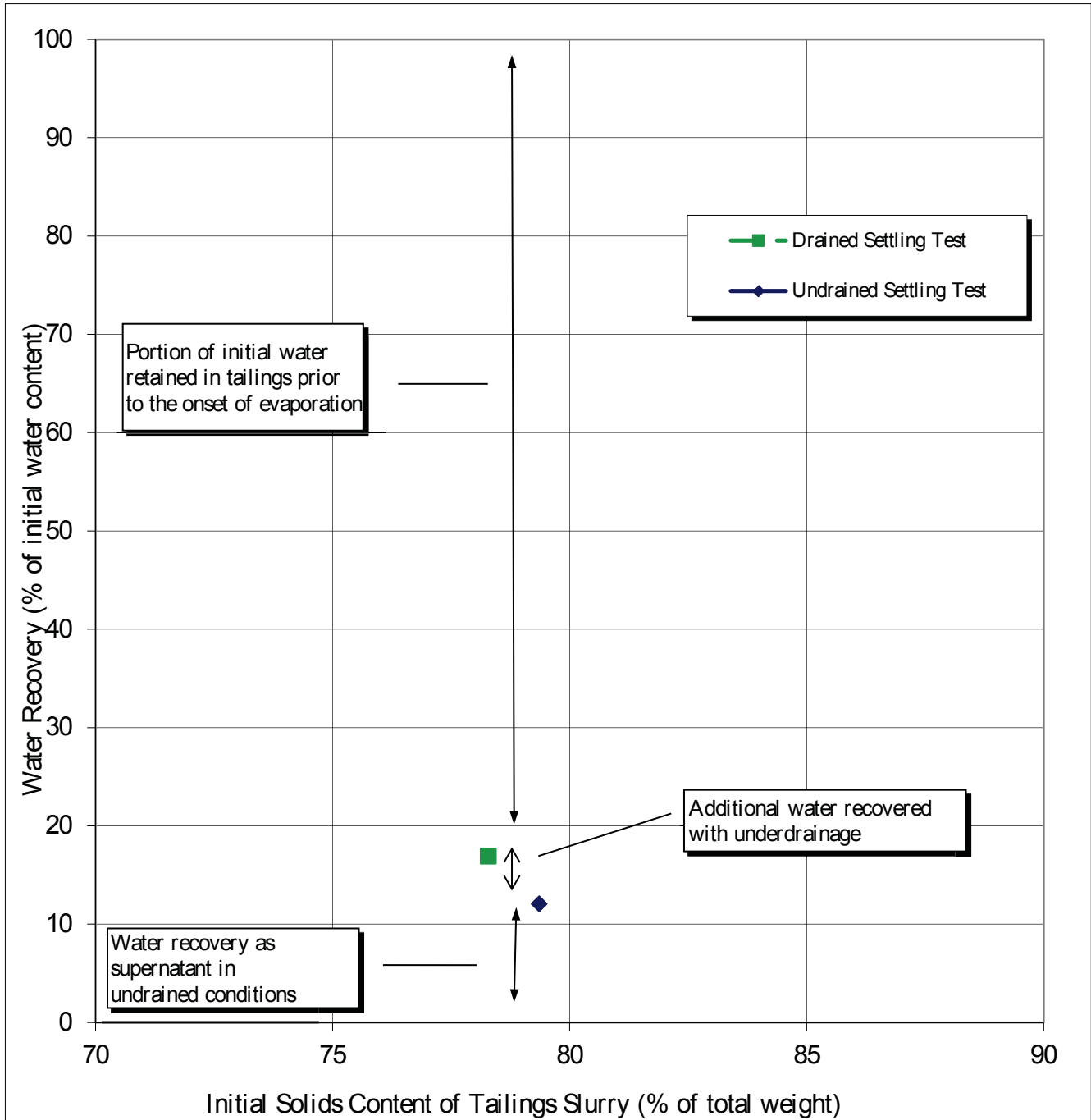
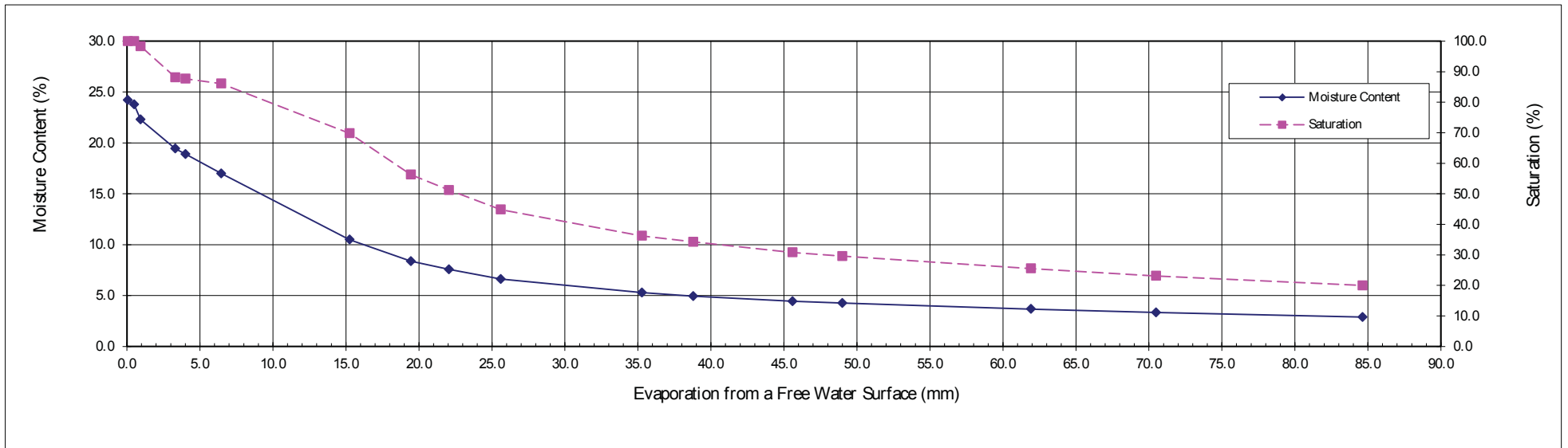
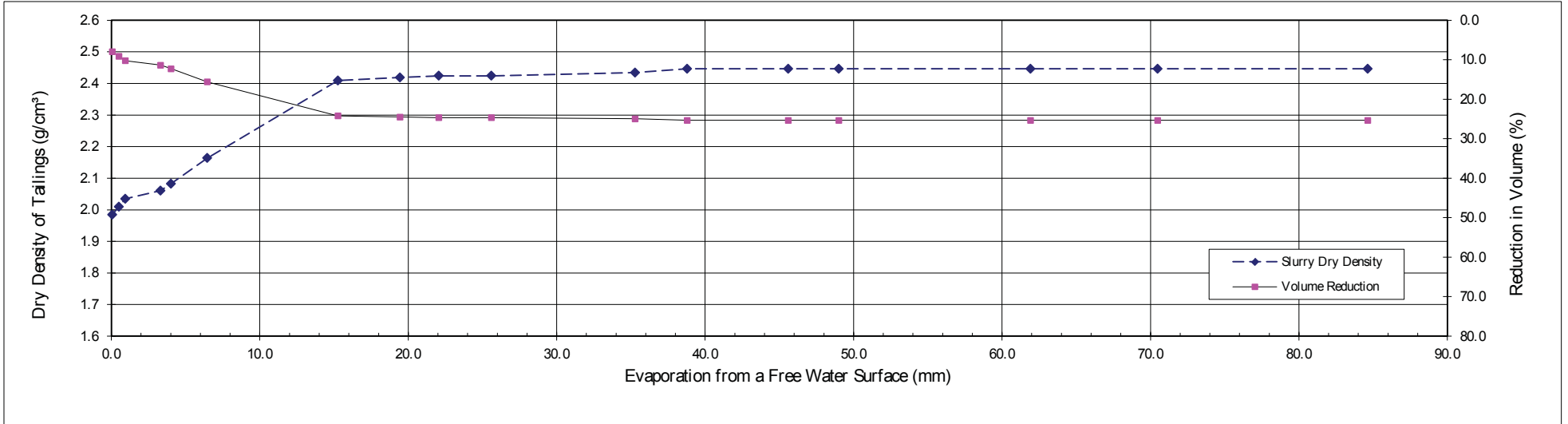

FIGURE 1.3

Black Butte Copper
VA101-460/03

LCT Tailings Virgin Material
VARIATION OF TAILINGS PARAMETERS WITH ONGOING EVAPORATION
79%



APPENDIX D
SITE WIDE WATER BALANCE
(Pages D-1 to D-11)

July 6, 2017

File No.:VA101-00460/03-A.01
Cont. No.:VA17-01139

Mr. Jerry Zieg
Vice President, Exploration
Tintina Resources Inc. (Vancouver)
10th Floor - 595 Howe Street
Vancouver, British Columbia
Canada, V6C 2T5

Dear Jerry,

Black Butte Copper Project Water Balance – Updated Surface Water Transfer to Water Treatment Plant

The Black Butte Copper Project (the Project) is a proposed underground copper mine located approximately 32 km north of White Sulphur Springs, Montana. An update to the life-of-mine site wide water balance model has been completed by Knight Piésold (KP) to incorporate the transfer of surface water from the Process Water Pond and the Cemented Tailings Facility to the Water Treatment Plant, with subsequent treatment and release to the environment. Surface water includes direct precipitation on mine facilities, as well as runoff contributing to mine facilities. This letter details the model parameters, assumptions, and results.

This water balance is an update to the KP letter *Black Butte Copper Project Water Balance – Updated Surface Water Transfer to Water Treatment Plant* (KP, 2016) issued to Tintina Resources Inc. (Tintina) on April 28, 2016.

The model was developed using the GoldSim[®] modeling platform. Deterministic and stochastic approaches were used, and 15 years were modeled including two pre-production years and 13 years of operations.

1 – MODEL PARAMETERS AND ASSUMPTIONS

The following sections outline the parameters and assumptions that were used to create the water balance model. The model results are dependent on these assumptions, and only valid if the parameters remain as outlined below.

1.1 GENERAL

Cemented tailings disposal is the chosen waste management method for the Project. The tailings will be impounded in the CTF, as shown on Figure 1. The PWP will store water from various inputs such as mill circulating load and the mill reclaim water. The PWP also collects surface water runoff and precipitation reporting to the PWP, including the water transferred from the CTF; all of which will be conveyed to the WTP, treated, and released to the environment.

Make-up water for the PWP will be sourced from the water treatment plant from the RO Reject water. In addition, freshwater will be supplied to the mill for special uses from underground dewatering after it has been treated in the WTP. Any treated water not being used for mine operations will be released to the environment.

Meteorological parameters for the model were developed by KP using site specific data in conjunction with regional data as described in KP's meteorological data analysis memo VA15-02445 (KP, 2015). The determined mean monthly precipitation and evaporation values are used as inputs in the model for each year. It is also assumed that the precipitation from November through to March falls as snow and accumulates as snowpack until the spring, when it melts during April and May. Therefore, the precipitation that accumulates between November and March will report to the PWP during April and May. A stochastic model was created with monthly coefficient of variations for the precipitation record to simulate dry year and wet year conditions.

The mill input and output requirements, along with miscellaneous freshwater requirements (truck wash, dust control etc.), were provided to KP by Tetra Tech (TT) via email correspondence with Jianhui Huang, dated September 16, 2015 (TT, 2015). The mill requirements were provided as annual rates for the life of mine. The preliminary inputs to the water balance model are shown in Table 1.

Table 1 Water Balance Inputs

Component	Units	Value	Source
Hydrometeorology			
Mean Annual Precipitation	mm	416	KP
Mean Annual Pond Evaporation	mm	514	KP
Runoff Coefficient (Undisturbed Ground)	mm	0.2	KP
Runoff Coefficient (Disturbed Ground /Facility Footprints)	mm	1.0	KP (Assumes no seepage from facilities)
Ore Production			
Ore Water to Mill	m ³ /yr	12,000 to 52,000	John Huang, TT ¹
Tailings Production			
Nominal Mill Process rate	tonne/day	3,300	Tintina
Tailings Dry Density	tonne/m ³	2.0	Tintina
Tailings Specific Gravity	-	3.77	Tintina
Tailings Solids Content	-	74% ²	Tintina
Tailings Water to CTF	m ³ /yr	51,000 to 221,000	John Huang, TT ¹
Tailings Water to Underground	m ³ /yr	42,000 to 186,000	John Huang, TT ¹
Water Lost to Voids	%	100%	Assumption
Mill Process			
Freshwater Requirements	m ³ /yr	44,000 to 192,000	John Huang, TT ¹
Water lost to Concentrate	m ³ /yr	4,000 to 16,000	John Huang, TT ¹
Thickener Overflow	m ³ /yr	938,000 to 4,107,000	John Huang, TT ¹
Required Water from the PWP	m ³ /yr	979,000 to 4,286,000	John Huang, TT ¹
Other Freshwater Use	m ³ /yr	49,000	John Huang, TT
Underground Dewatering	m ³ /yr	995,000	Hydrometrics

NOTES:

1. Range of values for the life of mine, based on the production schedule.
2. A tailings solids content of 74% was utilized in the water balance model to provide a conservative estimate of mill water consumption. A tailings solids content of 79% was utilized for all other design work.

1.2 WATER MANAGEMENT

The PWP has been designed for a maximum operating volume of 200,000 m³. This analysis assumes a minimum allowable pond volume of 120,000 m³ and a maximum allowable volume of 200,000 m³, thereby defining the operating range as 120,000 m³ to 200,000 m³.

The PWP starting volume of 120,000 m³, likely sourced from underground dewatering, will be in-place two months prior to the start of operations. The PWP monthly make-up water is calculated as additional water required to satisfy mill water requirements once the minimum allowable volume is reached in the PWP, and is represented by the RO Reject water as shown on Figure 2.

Each modeled mine year starts in June, as it was assumed that the mill would initially begin operations following the spring freshet period (April and May) of the first year of operations. It is assumed that pond water accumulating in the CTF will be pumped to the PWP immediately. Surface water, as runoff, and direct precipitation reporting to the mill is assumed to be routed to the WTP.

A large percentage of runoff within the CTF and PWP catchment areas will be diverted via a surface water diversion ditch system and discharged downstream (Figure 1); however, there is still a portion of the catchment area surface runoff that reports to the respective facilities. The runoff coefficient for undisturbed ground was assumed to be 0.2 based on the Manhattan Design Standards report (Thomas, et al. 2008). A runoff coefficient of 1.0 was assumed for disturbed ground surfaces, as the facilities will be geomembrane-lined and therefore impervious. It was also conservatively assumed that there would be no seepage from lined facilities.

The portion of the surface water runoff that is not diverted around the CTF and PWP (Figure 1), as well as the precipitation that falls directly on the two facilities will be collected in the PWP and routed to the WTP for treatment prior to release to the environment. The make-up water required to operate the mill will be sourced from underground dewatering.

The water balance schematic, shown on Figure 2, was used as the basis for model development and shows the annual inflows and outflows from the facilities during the sixth year of production (year 6) under mean climatic conditions.

The site water management plan, as interpreted by KP based on discussions with Tintina, is described below:

- The primary source of reclaim water for the mill is the PWP.
- Surface water reporting to the CTF will be transferred to the PWP.
- Surface water reporting to the PWP, including that transferred from the CTF, will be transferred to the WTP where it will be treated prior to discharge to the environment.
- Additional make-up water required by the mill is assumed to be supplied from the water treatment plant and stored in the PWP.

Evaporation and direct precipitation on the PWP pond were accounted for in the water balance. The surface area was calculated for each time-step using the Depth-Area-Capacity (DAC) data for the facility.

1.3 GENERAL MODEL LIMITATIONS

The following limitations should be considered when reviewing the results of the water balance model.

- Increasing consolidation of the tailings was not accounted for in the model; instead it was assumed that all water locked in the cemented tailings voids is not recoverable (void loss).
- Snowpack, snowmelt and sublimation parameters are based on estimates as no detailed study has been conducted.

2 – WATER BALANCE MODEL RESULTS

Three separate scenarios were modeled using the life-of-mine water balance in order to obtain an understanding of the water requirements of the PWP during operations. The model was run deterministically for the mean case, and stochastically for the abnormally wet (95th percentile) and abnormally dry (5th percentile) cases. A gamma distribution was assumed for the precipitation data in the stochastic models and a Monte Carlo simulation was executed using 5,000 iterations. The estimated monthly precipitation volumes reporting to the proposed mine site, and the resulting effects on the volumes in the PWP, have been presented in terms of probabilities of occurrence for the three scenarios:

- **Scenario 1 – Mean:** The model was run deterministically and the results correspond to mean monthly climatic conditions (Figure 2).
- **Scenario 2 – 95th Percentile (Wet):** The results correspond to abnormally wet conditions, and represent the climatic conditions to be exceeded once every 20 years, on average.
- **Scenario 3 – 5th Percentile (Dry):** The results correspond to abnormally dry conditions, and represent the climatic conditions expected to be exceeded 19 years out of 20, on average (i.e. volumes will not exceed these values more than once every 20 years, on average).

The estimated PWP pond volume prior to the surface water transfer to the WTP and groundwater transfer to the PWP is shown on Figure 3, for all three climatic scenarios. The volume trends show that there is sufficient

storage capacity in the PWP during abnormally wet year scenarios (95th percentile). The PWP pond volume, after surface water transfer to the WTP and groundwater transfer to the PWP, is shown on Figure 4; which shows that the pond volume for each scenario is similar after the water transfer is included in the model. The amount of water transferred to the WTP and released to the environment is greater than the amount required to keep the pond volume within the mean scenario operating range for mean and abnormally wet conditions. The results for all 3 scenarios are outlined in the sections below.

2.1 SCENARIO 1 RESULTS (MEAN)

The PWP will be supplemented with approximately 162,000 m³ of groundwater make-up throughout the year, on average. The average annual surface water transfer from the PWP to the WTP is 110,000 m³. The annual make-up requirements (RO Reject) and surface water transfer to the WTP, for the life of mine, are shown in Table 2.

Table 2 Scenario 1: Mean PWP Make-Up Water Requirements and Surface Water Transfers (m³)

Year	Total Make-up (RO Reject) Water to PWP	Surface Water Transfer from PWP to WTP
1	109,000	107,000
2	142,000	110,000
3	179,000	110,000
4	181,000	110,000
5	184,000	110,000
6	181,000	110,000
7	187,000	110,000
8	193,000	110,000
9	190,000	110,000
10	186,000	110,000
11	184,000	110,000
12	142,000	110,000
13	56,000	110,000

It should be noted that make-up water is only required during the winter months. The PWP fluctuates between approximately 120,000 m³ and 160,000 m³, after the surface water and RO Reject transfers.

2.2 SCENARIO 2 RESULTS (95TH PERCENTILE, ABNORMALLY WET)

The make-up requirements are the same under abnormally wet climatic conditions as mean climatic conditions (Table 2 above), but the average annual surface water transfer from the PWP to the WTP is increased to 232,000 m³ per year, on average. The annual surface water transfer volumes to the WTP are summarized in Table 3.

Table 3 Scenario 2: 95th Percentile (Abnormally Wet) Annual Surface Water Transfer to WTP (m³)

Year	Surface Water Transfer to WTP
1	227,000
2	231,000
3	232,000
4	232,000
5	230,000
6	234,000
7	235,000
8	232,000
9	233,000
10	232,000
11	230,000
12	231,000
13	232,000

The PWP pond volume fluctuates between 120,000 m³ and 160,000 m³ under wet climatic conditions, which is the same as Scenario 1, as shown on Figure 4. This is achieved by transferring a larger volume of surface water from the PWP to the WTP, and releasing it to the environment (232,000 m³), than the volume of groundwater that is transferred back to the PWP (110,000 m³).

2.3 SCENARIO 3 RESULTS (5TH PERCENTILE, ABNORMALLY DRY)

The make-up requirements are the same under abnormally dry climatic conditions as mean climatic conditions, but the average annual surface water transfer from the PWP to the WTP is reduced to 34,000 m³ per year. The annual surface water transfer volumes to the WTP are summarized in Table 4.

Table 4 Scenario 3: 5th Percentile (Abnormally Dry) Annual Surface Water Transfer to WTP (m³)

Year	Surface Water Transfer to WTP
1	32,000
2	35,000
3	34,000
4	34,000
5	35,000
6	34,000
7	35,000
8	35,000
9	34,000
10	34,000
11	34,000
12	34,000
13	35,000

The PWP pond volume remains the same as that for Scenarios 1 and 2, as shown on Figure 4. The volume of surface water that is transferred from the PWP to the WTP, and released to the environment (34,000 m³), is less than the volume of groundwater that is transferred back to the PWP (110,000 m³) in this Scenario.

3 – CONCLUSIONS AND RECOMMENDATIONS

It is necessary to supplement the PWP with make-up water from the WTP in order to achieve the design minimum pond volume based on the water balance and the conditions outlined in this letter. The results of the three scenarios modeled are outlined below:

All Scenarios

- Average annual groundwater make-up required to sustain the minimum pond volume = 162,000 m³

Scenario 1 (Mean Conditions)

- Average annual surface water volume transferred from the PWP to the WTP = 110,000 m³

Scenario 2 (Abnormally Wet Year)

- Average annual surface water volume transferred from the PWP to the WTP = 232,000 m³

Scenario 3 (Abnormally Dry Year)

- Average annual surface water volume transferred from the PWP to the WTP = 34,000 m³

It is recommended that the life-of-mine water balance model be updated as further information becomes available.

Please contact the undersigned with any questions or comments.

Yours truly,

Knight Piésold Ltd.

Prepared:



Mediha Hodzic, P.Eng.
Project Engineer

Reviewed:



Ken Embree, P.Eng.
Managing Principal

Reviewed:



Ken Brouwer, P.E.
President

Approval that this document adheres to Knight Piésold Quality Systems:

Attachments:

- | | |
|----------------|--|
| Figure 1 Rev 2 | Water Balance Model – Catchment Area Figure |
| Figure 2 Rev 4 | Annual Water Balance Schematic – Mean Case – Year 6 |
| Figure 3 Rev 2 | Process Water Pond Monthly Volumes – Estimate Prior to Water Transfers |
| Figure 4 Rev 2 | Process Water Pond Monthly Volumes – Post Water Transfers |

References:

Knight Piésold Ltd. (KP). 2015. *Black Butte Copper Project Meteorology Data Analysis Update*. Doc. No. VA101-460/3, VA15-02445. Prepared for Tintina Resources Inc. May 27, 2015.

Knight Piésold Ltd. (KP). 2016. *Black Butte Copper Project Water Balance – Updated Surface Water Transfer to Water Treatment Plant*. Doc. No. VA101-460/3, VA16-00564. Prepared for Tintina Resources Inc. April 28, 2016.

Tetra Tech (TT). 2015. Huang, Jianhui. "Update; Amec Mining." Message to Bob Jacko and Greg Magoon. September 16, 2015. E-mail.

Thomas, Dean, and Hoskins. *Design Standards and Specification Policy*. Manhattan, Montana: Town of Manhattan, Montana, 2008.

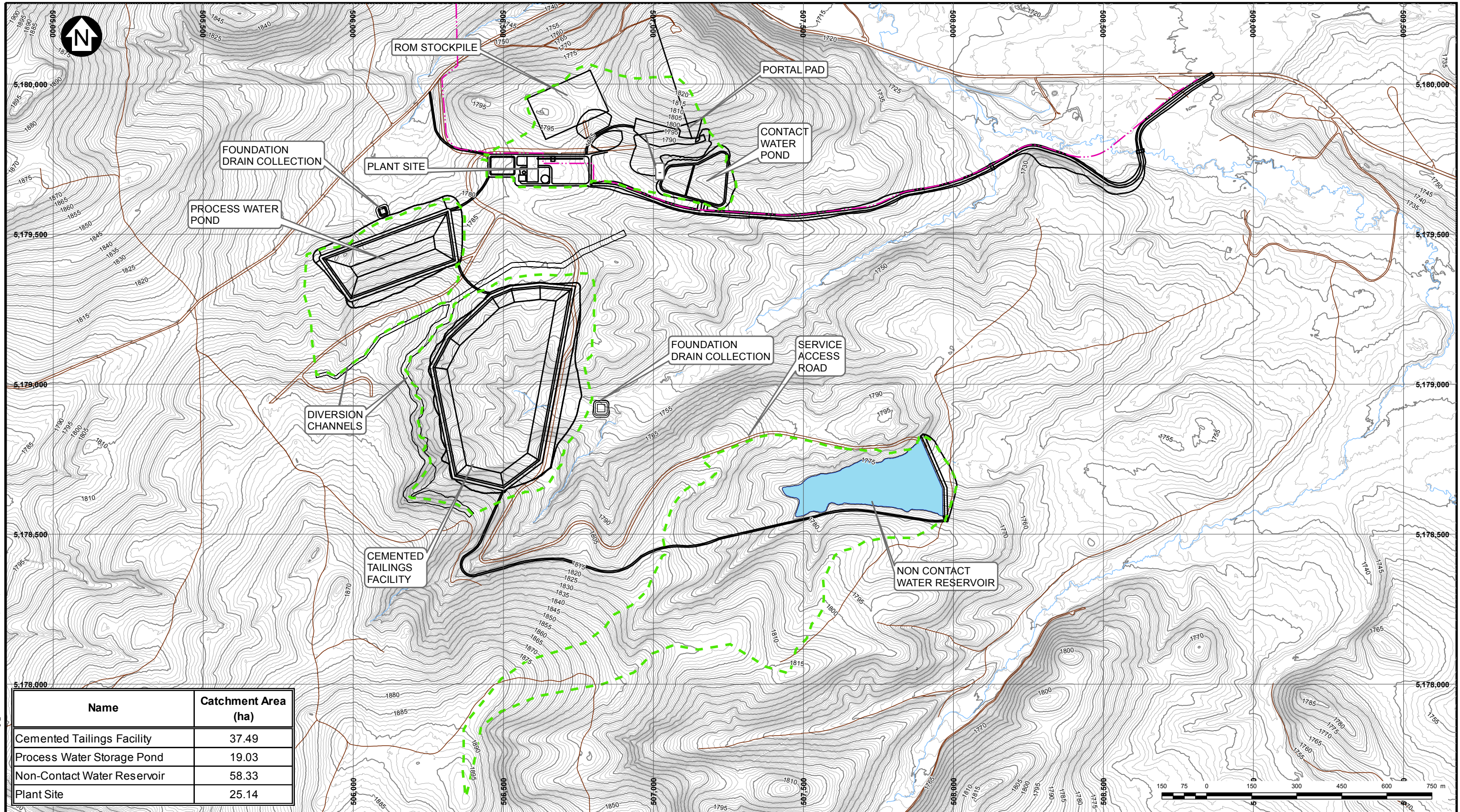

Name	Catchment Area (ha)
Cemented Tailings Facility	37.49
Process Water Storage Pond	19.03
Non-Contact Water Reservoir	58.33
Plant Site	25.14

LEGEND:

	ROAD		MINE FACILITIES
	CONTOUR (1 m)		
	CONTOUR (5 m)		
	STREAM		
	POWERLINE		
	CATCHMENT BOUNDARY		

NOTES:

1. BASE MAP: LIDAR 1 m CONTOURS AND STREAMS.
2. COORDINATE GRID IS IN METRES. COORDINATE SYSTEM: NAD 1983 UTM ZONE 12N.
3. THIS FIGURE IS PRODUCED AT A NOMINAL SCALE OF 1:12,000 FOR 11x17 (TABLOID) PAPER. ACTUAL SCALE MAY DIFFER ACCORDING TO CHANGES IN PRINTER SETTINGS OR PRINTED PAPER SIZE.
4. CONTOUR INTERVAL IS 1 METRE.



TINTINA RESOURCES INC.
 BLACK BUTTE COPPER PROJECT
**WATER BALANCE MODEL
 CATCHMENT AREA FIGURE**

Knight Piésold CONSULTING	PIANO. VA101-460/3	REF NO. VA17-01139
	FIGURE 1	

SAVED: M:\101004603\GIS\Figs\VA17-01139 Water Balance Catchments\Fig_1_WaterBalanceModelCatchmentArea.mxd, Jul 06, 2017 9:46 AM, kkrusozva

REV	DATE	DESCRIPTION	DESIGNED	DRAWN	REVIEWED
2	07JUL17	ISSUED WITH LETTER	KK	KK	KJB

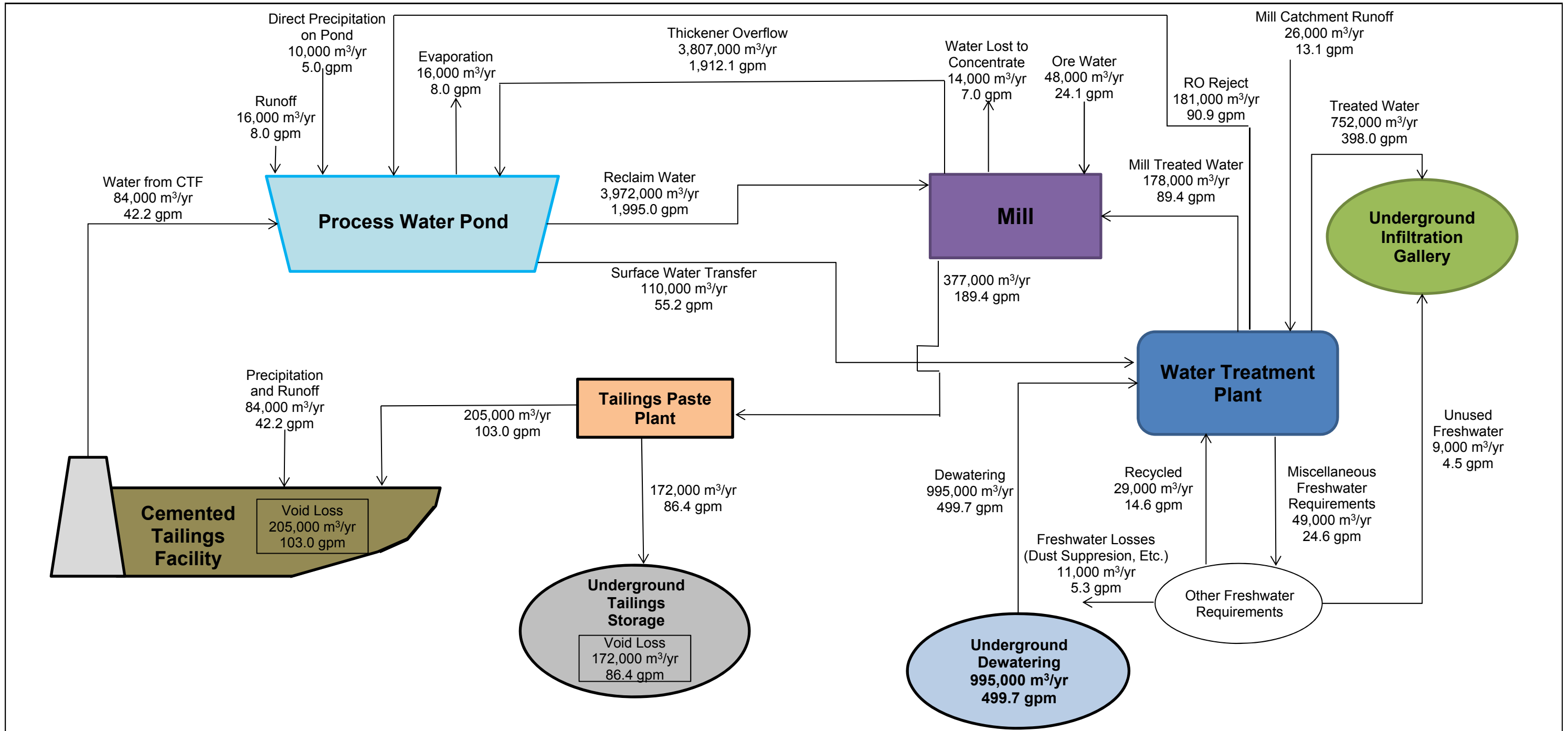

NOTES:

1. ALL WATER VOLUMES ARE EXPRESSED IN UNITS OF CUBIC METRES PER YEAR AND GPM EQUIVALENTS.
2. WATER IN TAILINGS PASTE IS ASSUMED TO BE UNRECOVERABLE.
3. SEEPAGE IS ASSUMED TO BE ZERO AS THE FACILITIES ARE LINED.

4	26APR'17	ISSUED WITH LETTER	BW	MH
REV	DATE	DESCRIPTION	PREP'D	RVW'D

TINTINA RESOURCES INC.	
BLACK BUTTE COPPER PROJECT	
ANNUAL WATER BALANCE SCHEMATIC MEAN CASE - YEAR 6	
<i>Knight Piésold</i> CONSULTING	P/A NO. VA101-460/3
	REF. NO. VA17-00734
FIGURE 2	
	REV 4

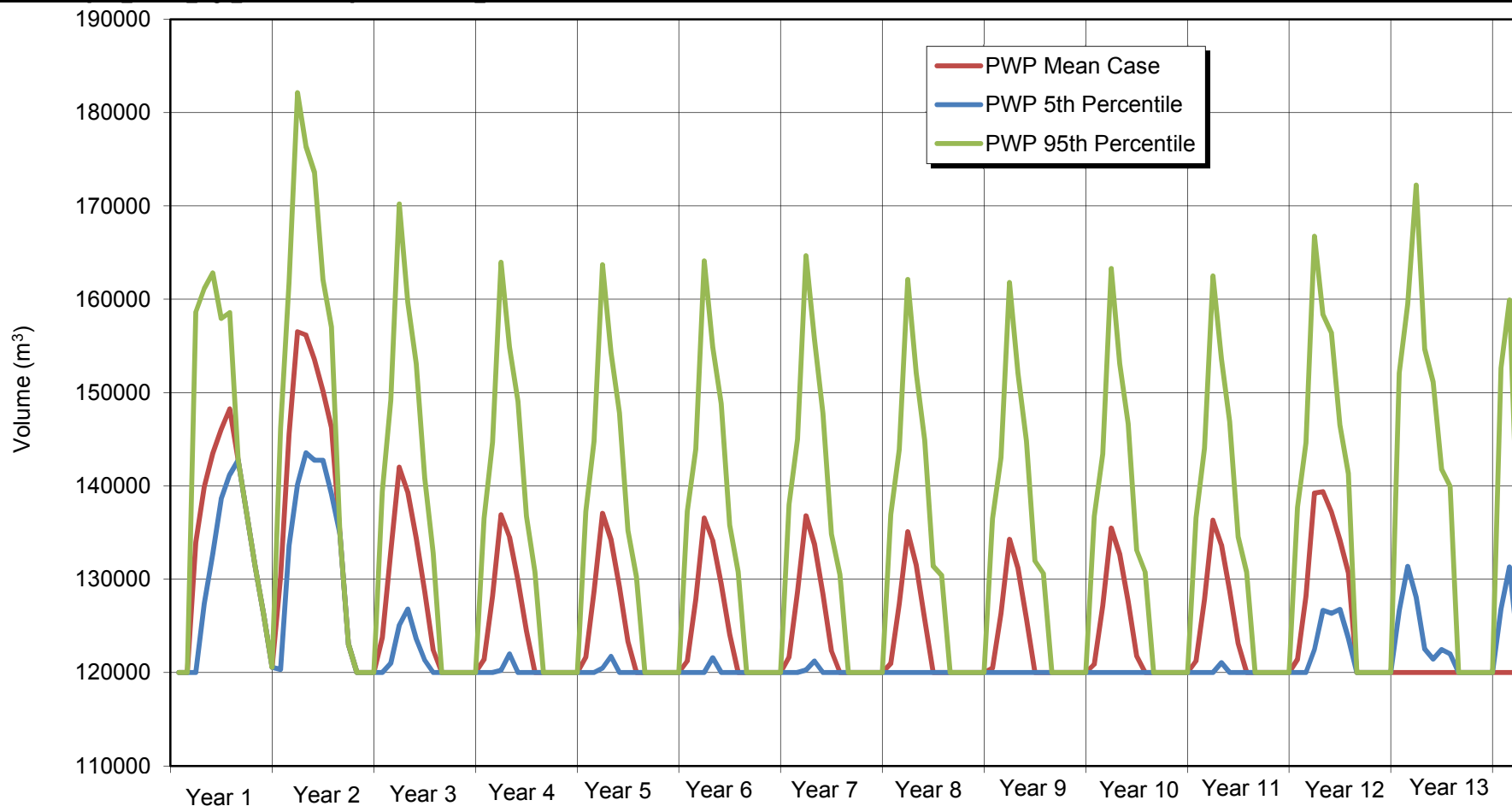

NOTES:

1. AN INITIAL VOLUME OF 120,000 m³ IS ADDED TO THE PWP 2 MONTHS PRIOR TO THE START OF OPERATIONS.

TINTINA RESOURCES INC.	
BLACK BUTTE COPPER PROJECT	
PROCESS WATER POND MONTHLY VOLUMES ESTIMATE PRIOR TO WATER TRANSFERS	
<i>Knight Piésold</i> CONSULTING	P/A NO. VA101-460/3
	REF. NO. VA17-01139
FIGURE 3	
	REV 2

2	28APR17	ISSUED WITH LETTER	MH	GM
REV	DATE	DESCRIPTION	PREP'D	RVW'D

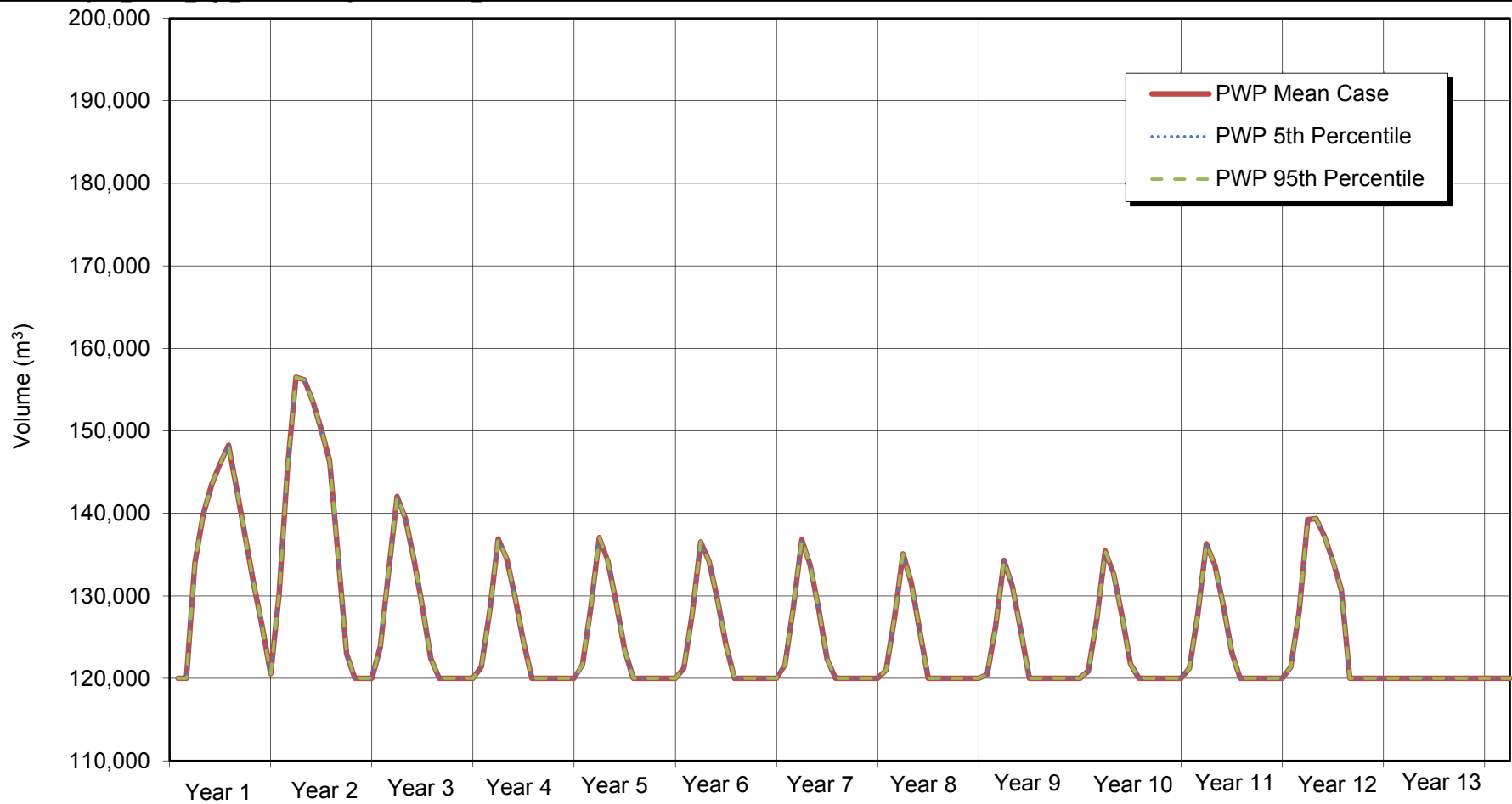

NOTES:

1. AN INITIAL VOLUME OF 120,000 m³ IS ADDED TO THE PWP 2 MONTHS PRIOR TO THE START OF OPERATIONS.

TINTINA RESOURCES INC.	
BLACK BUTTE COPPER PROJECT	
PROCESS WATER POND MONTHLY VOLUMES POST WATER TRANSFERS	
<i>Knight Piésold</i> CONSULTING	P/A NO. VA101-460/3
	REF. NO. VA17-01139
FIGURE 4	
REV 2	

2	28APR'17	ISSUED WITH LETTER	MH	GM
REV	DATE	DESCRIPTION	PREP'D	RVW'D

APPENDIX E

TAILINGS DELIVERY SYSTEM DESIGN

(Pages E-1 to E-17)

FEBRUARY 23, 2016

MG PROJECT 147315
BLACK BUTTE TAILINGS PIPELINE

KNIGHT PIESOLD LTD.
VANCOUVER, BC

**PROJECT MEMORANDUM 001 Rev. 01
TAILINGS PIPELINE FEASIBILITY STUDY**

1.0 PURPOSE

Knight Piesold Ltd. (KPL) has been retained by Tintina Resources Inc. (TRI) to perform a feasibility study on the tailing management facilities at their Black Butte Copper project in central Montana, USA. Approximately 45% of the tailings produced are used for cemented paste back-filling of underground stopes. The remaining tailings are stored in a surface tailings facility. KPL has retained MG Engineering Inc. (MG) to develop a conceptual piping system (pump discharge to spigot) to deliver the excess tailings to the surface tailings facility. This memorandum summarizes the design of the proposed tailings pipeline system and will be incorporated into KPL's overall feasibility study report.

2.0 GENERAL DESCRIPTION

Background

The proposed Black Butte copper mine (Mine) is located 85 km south-southeast of Great Falls, Montana (see Fig. 1).



Figure 1: Location of proposed Black Butte copper mine (TRI)

The ore body is located below lightly forested, rolling hills with a nominal surface elevation of 1780 m above mean sea level (AMSL). The central Montana region has a semi-arid climate with cold winters. Nearby Great Falls, MT has average low temperatures of -10°C in December and January, and may see extreme low temperatures below -40°C. Daily low temperatures may drop below the freezing point of water for about eight months out of the year. Since the Mine location is 800 m higher than Great Falls, site temperatures would be expected to be about 5C° cooler on average (using 6.4C°/km low altitude lapse rate).

“Fixed” Facilities

The copper ore is recovered by underground mining methods and delivered to a concentrator (Plant) located ~1.0 km south of the Mine, at an elevation of 1782 m AMSL. The Plant processes 139 metric tonnes per hour (tph) of ore and generates 120.8 tph of tailings. For the purposes of this analysis, it is assumed that ore and operating variability causes the instantaneous tailings production to vary by ±10%.

TRI has opted to use cemented paste for both the underground tailings facility (UTF or stopes) and surface “cemented tailings facility” (CTF). The tailings are thickened to a high yield stress “paste” and mixed with a binding agent (“cement”) for disposal. The cemented paste is pumped either to the UTF (~45% of the time) or to the CTF (~55% of the time); there is no flow splitting.

It is understood that TRI intends to use the same paste pump(s) to deliver paste to both the UTF and the CTF. The paste pump station will be designed (by others) as part of the Paste Plant design. The design pressure of the pump station is determined by the pipeline with the highest pressure requirement. The route of the pipeline to the UTF is not known, and it will change over the life of the Mine as the pour location moves from stope to stope. The Johnny Lee ore bodies are between 150 m (Upper Zone) and 500 m (Lower Zone) below the final CTF spigot elevation, which will decrease the UTF pump pressure by 33 to 110 bar relative to a CTF paste pipeline of the same size and length. For this study it is assumed that the CTF pump pressure will set the paste pump station pressure and power requirements.

The center of the CTF impoundment is located ~600 m south of the Plant in a valley that slopes downwards from west to east. The CTF is a paddock formed by a perimeter berm. The berm is built up in stages, with an initial crest elevation of 1784 m and a final crest elevation of 1799 m. The CTF also stores potentially acid generating waste rock, so a haul road runs from the Plant to the northeast corner of the berm. A water diversion channel runs above the west and north sides of the CTF. The channel has an elevation of ~1825 m at the south end and ~1775 m at the northeast end. The current KPL tailings deposition plan has the waste rock disposal area at the north end of the CTF and a single paste discharge point (spigot) at the south end of the CTF.

3.0 DESIGN BASIS

The design basis for the on-surface cemented paste pipeline is given in Table 1.

Table 1: Design Basis for Tailings System

Item	Units	Quantity	Comments
Plant elevation	m amsl	1782	KPL
Initial crest elevation	m amsl	1784	KPL
Final crest elevation	m amsl	1799	KPL
Nominal tailings tonnage	t/h	120.8	92% availability
Tailings specific gravity	t/m ³	3.77	KPL (~40% pyrite)
Binder specific gravity	t/m ³	3.0	OPC/FA
Binder addition rate	-	5%	Est. (7% for backfill)
Paste solids specific gravity	t/m ³	3.73	Combined
Nominal paste tonnage	t/h	126.8	Solids only
Paste solids content	%w/w	74.0	KPL
Paste volume concentration	%v/v	43.5	Calculated
Paste specific gravity	t/m ³	2.19	Calculated
Nominal paste flow	m ³ /h	78.2	Calculated
Design paste flow range	m ³ /h	71 to 86	Process variability

4.0 DESIGN CONSIDERATIONS

The following issues are considered in the routing and pipe selection for the Black Butte CTF paste transfer pipeline:

Double-Wall Pipe Secondary Containment

TRI has requested that double-wall (i.e. cased) pipe be used to provide secondary for environmental protection between the Plant and the CTF berm. Secondary containment is not required on the CTF berm because a rupture of the on-berm piping would result in paste flowing into the impoundment. Paste will not easily flow through the annulus between the pipe and the casing, so it must be forced through by the pump. Since the paste can discharge out either end of the casing, it is assumed that the pressure rating of the casing is at least half the design pressure of the pump and pipe.

Note: Double-wall pipe is just one option for secondary containment on this type of pipeline. There are other options that are equally effective for containment. It is suggested that a trade-off study of other secondary containment options be carried out in the next design phase of the project.

Corrosion

Overland slurry pipelines may be subjected to external corrosion, internal corrosion, and internal erosion. If this corrosion is allowed to go unchecked, sections of the pipeline will eventually need to be replaced to prevent leaks or rupture. Coatings are used mitigate external corrosion but are not suitable for internal corrosion protection of slurry lines; the flowing slurry quickly erodes the coating away. HDPE pipes are corrosion resistant but are only suitable for pressures up to ~20 bar (290 psi), which is too low for this paste pipeline (at least near the Plant). Stainless steel pipelines are too expensive, especially with heavy wall pipes.

The two common ways to deal with internal corrosion are by increasing the wall thickness of the steel pipe or installing a liner (HDPE, rubber, etc.). Thick walled pipe is the preferred method since it is easier to install, monitor, and repair. The “sacrificial” steel increases the actual pressure rating of the pipe so it adds to the factor of safety in the initial years of operation (i.e. until it is worn away). However, if the slurry is too corrosive the amount of extra steel required would be excessive and difficult to predict, so a corrosion resistant liner is preferred.

No corrosion information is available on the Black Butte tailings or process water. However, it is known that the tailings contain a significant amount of potentially acid generating sulphide minerals, which often leads to corrosive slurry/water. The paste and water will be assumed to be corrosive to carbon steel until proven otherwise by corrosion testing. The pipeline is assumed to be HDPE-lined steel.

A cased pipe may also be subjected to corrosion of the metal forming the walls of the annulus and the spacers. Unless the pipe profile allows it to be self-draining (to the ends or sumps along the route) then water can build up in the annulus; usually from condensation but possibly water left over from the hydrotest or a pinhole leak in the main pipe.

Intermittent Operation

A conventional tailings pipeline operates continuously whenever the Plant is operating. The CTF pipeline operates for three or four days, and then it is idle for three or four days. Because the paste is cemented and the pipeline is located in a region that drops well below freezing, it is not possible to leave the paste in the pipeline during the idle periods.

Flushing

If a conventional tailings pipeline shuts down when the line is full of slurry, the solids fall out of suspension and form a loosely-packed bed on the bottom of the pipe. Depending on the solids concentration of the slurry, this bed takes up between one-third and one-half of pipe’s cross section. As long as the pipe slope is not too steep (>10%) the bed will remain in place indefinitely while the line is stopped, although it may pack tighter over time. On restart, water flows in the free path above the bed and its turbulence quickly lifts the solids back into suspension and erodes the bed away.

With an un-cemented paste pipeline the slurry already is near its settled (bed) concentration so little bulk settling occurs when flow ceases. An open flow path

along the entire length of the pipe is unlikely, so clearing the pipe by resuspension is not a viable option. However, for idealized paste (time and shear independent) it also means that there is no change in the paste rheology, so the pipeline can be restarted simply by bringing it back up to operating pressure. For real paste the restart pressure may be higher than operating pressure. (Note: For those not familiar with time-dependent rheology, a simple analogy is normal friction: static (restart) friction is higher than sliding (operating) friction.)

With a cemented paste pipeline the situation for short duration (<1 hr.) cessations in flow is essentially the same as for un-cemented paste. However, for longer flow cessations, curing of the binder becomes an issue. The apparent yield stress rises and the flowability decreases until it is no longer possible to restart the pipeline using the pump. The cement will eventually set hard and the pipeline may need to be abandoned. It is unlikely that a cemented paste pipeline could be restarted if left stagnant for three or four days. As a result, it is necessary to flush the line with water at the end of each paste pour. High pressure water is used to push the paste out of the line and then the water is left flowing for a period to wash binder residue out of the pipe. Flushing a near-horizontal cemented paste pipeline requires a water source with an operating pressure that is at least as high as the design operating pressure when transporting paste.

Drainage

At the end of the flushing operation the pipeline will be full of water unless there is some way to drain it. With a down-sloped pipeline this is easily accomplished: the water free-drains out the low end of the pipe with no operator input. With an up-sloped pipeline the drainage needs to be back towards the pump; usually into a sump after the operator opens a drain valve.

With a “V” shaped pipeline profile it is not possible to drain to either end of the pipeline: water will be trapped in the low points. Drains can be installed at each low point to let the water in the pipe drain through a valve (and the casing annulus free-drain) into a sump. The number of low points should be minimized because the valve and flanges are leak risks, the tee is a wear (leak) risk, and the sump needs to be emptied. During the winter, the sump will need to be emptied quickly to avoid freezing.

The other option is to drain as much water out of the pipe as possible and then use compressed air to blow the water out of the pipeline, either directly or by pushing a pig (swab) through the line. If the air pressure can exceed 1.03 bar, the tailings pipeline needs to be designed and built as a pressure pipeline (e.g. to B31.3) and, in many jurisdictions the pipe must be registered with the Boiler Branch.

Cold Weather

Pipelines transporting fluids in locations that experience extended periods below that fluid’s freezing point are at risk of freezing. A frozen pipe will be inoperable and (when the fluid is water based) the crystallization expansion may cause the pipe to yield or rupture. The freezing risk increases as the ambient temperature drops, the pipeline diameter decreases, the flow rate of the fluid decreases, and the time in the pipe increases. The Black Butte site can drop well below freezing during more than half the year, the paste line has a small diameter, the paste has a

low velocity when the pipeline is operating, and the system is regularly idle for days at a time: the freezing risk is very high. However, there are proven ways to mitigate the freezing risk.

Burial below the frost depth: Burial is the best way to protect a pipe from freezing; a pipe full of water can be left stagnant indefinitely. It is the standard method used to protect fire mains and long distance slurry pipelines. The frost depth varies, but is likely in the 1.0 to 2.0 m range. Burial also has the advantage that it supports and anchors the pipe, and it protects it from most external damage (e.g. being hit by a vehicle). The main disadvantage of burial is that it is difficult to monitor the condition of the pipe or observe leaks.

Insulation: Insulation is effective as long as the pipe is operating; the friction loss in the flowing paste is converted into heat, partially offsetting the heat loss through the insulation. This is sufficient to keep the paste from freezing during the relatively short period that it is in the pipe. However, insulation will not protect a stagnant pipeline during a prolonged cold period because it only reduces heat transfer, it does not eliminate it. At an air temperature of -40°C , an uninsulated 0.2 m (8") pipe full of water at 10°C would start to freeze in less than an hour, and adding 0.1 m of insulation would increase that to about a day (depends on type of insulation, wind, etc.). To get four days protection would require ~ 0.4 m of insulation. The air space in the annulus of the cased section of the pipeline will provide some extra insulation to the inner pipeline, but the protection level is difficult to assess.

Insulation plus trickle flow: Maintaining a water flow that is just enough that the water is still a few degrees above freezing when it exits the pipe will prevent freezing even in a bare pipe. Adding insulation decreases the required water flow (by reducing heat loss) and protects the pipeline during short power outages. However, pumping a continuous stream of water into the CTF during cold weather periods is likely to cause operational issues in the impoundment. This option is more appropriate for areas with short and infrequent cold periods.

Insulation plus drainage: Drainage is effective because there is nothing to freeze when the pipeline is not operating. Adding insulation protects the pipe during the drainage period and short power outages. The main disadvantages of this system are that not all pipeline profiles are easily drainable and the pipe will experience significant thermal expansion/contraction: a 1000 m pipe will contract 0.5 m if its temperature drops by 45°C . Introducing fluid into a very cold pipe can also cause operational issues (i.e. freezing of the leading edge of the slug).

Insulation plus heat tracing: Heat tracing (usually electrical tape) delivers heat energy between the pipe and insulation. If the heat delivered equals the heat lost through the insulation, the pipe can be left stagnant indefinitely. The insulation both minimizes the heating energy required and protects the pipe during short power outages. This option also eliminates most of the expansion/contraction and cold restart issues.

Leakage

Considerable effort and expense will go into preventing a release of paste or flush water into the surrounding environment. Nevertheless, good pipeline design should always assume that a major leak is possible anywhere along the pipe. Not all leak locations will have the same impact: a leak that flows into the CTF a score of metres upstream of the spigot does not matter; a leak that flows into a fish bearing stream will be a major issue. A route that minimizes the length of pipe where a leak would not be contained by the surrounding terrain is usually preferred unless it would cause other risk factors (e.g. higher pressure).

Summary

For this study it is assumed that the paste pipeline is HDPE-lined carbon steel with double-wall containment for the segments off the CTF berm. The pipeline will be installed on the surface, and profiled to allow drainage of the pipe and casing. Where possible the pipe will be run through areas where leakage from a ruptured pipe would be contained by the terrain profile.

5.0 ROUTE OPTIONS

The CTF pipeline route and profile is essentially fixed for the life of the Mine. The only significant change will be the 15 m increase in elevation of the on-berm portion of the pipeline as the impoundment grows. For this type of pipeline, “route optimization” effectively means selecting a route that minimizes installation and operating difficulties, as well as the pipe’s overall length. Three route options have been identified.

Option 1: North Plant Exit to South CTF Spigot

The base case option assumes that the paste pipeline follows the haul road from the Plant to the CTF and then runs down the east berm of the CTF before turning west to the spigot point (see Fig. 2). The total pipe length is 1800 m.

The advantage of this route is that the pipeline right-of-way (RoW) is mostly in place. The haul road only needs to be widened by ~2 metres and the CTF berm crest can be used as is. The RoW cost is mainly building the berms for protection and isolation of the pipe. Haul roads are built with relatively shallow slopes and the CTF berm is flat so pipeline construction is easy. There is no need to construct pipeline crossings because the pipeline always stays on the east side of the haul road and the pipe will use the road bridge to cross the water channel. Finally, the haul road is regularly travelled by the waste rock trucks and people accessing the CTF, so a leak that occurs outside the CTF impoundment is likely to be noticed even if it happens between dedicated route inspections.

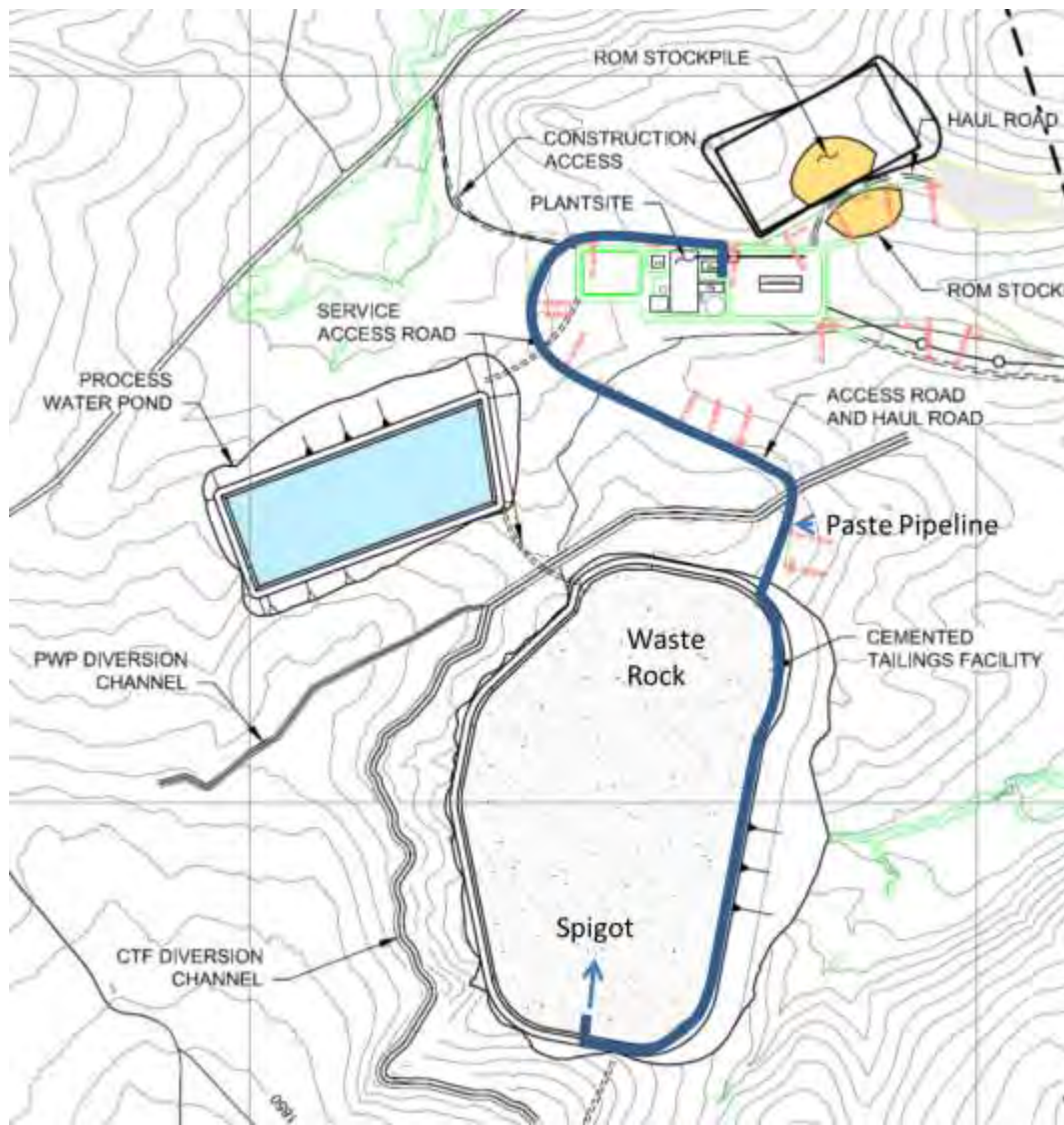

Figure 2: Option 1 pipeline route: North Plant to South CTF Spigot

One problem with the base case route is that it is long. Joining the haul road on the north side of the Plant means it has to loop around the west end of the Plant and then double back. There is a small ridge (~20 m high) between the Plant and the CTF. To maintain shallow grades, the haul road loops around the north flank and east end of this ridge before reaching the northeast corner of the CTF (see Fig. 2). As a result of this circuitous route, it takes 1000 m of pipe to reach the CTF, even though the straight line distance is only 400 m. This 600 m of extra pipe is all in the off-berm section, which is expensive (double-walled) and where a leak would be most problematic. It also increases the overall pumping pressure/power by ~50%.

Another problem with this route is that it is “W” shaped, which increases the complexity of draining the pipe and the casing. Sumps will be required on the west end of the Plant and where the pipeline moves up onto the CTF berm.

Option 2: South Plant Exit to North CTF Spigot

This route exits the south side of the Plant, crosses the haul road, runs up the north flank of the ridge, crosses the water channel, and then drops down onto the north berm of the CTF. The on-berm section of the paste pipeline will go straight across the crest and discharge into the CTF through the spigot (see Fig. 3). The total pipe length is 600 m. This route is only one-third the length of the Option 1 route and, all else being equal, the pump pressure and power will drop by a similar amount.

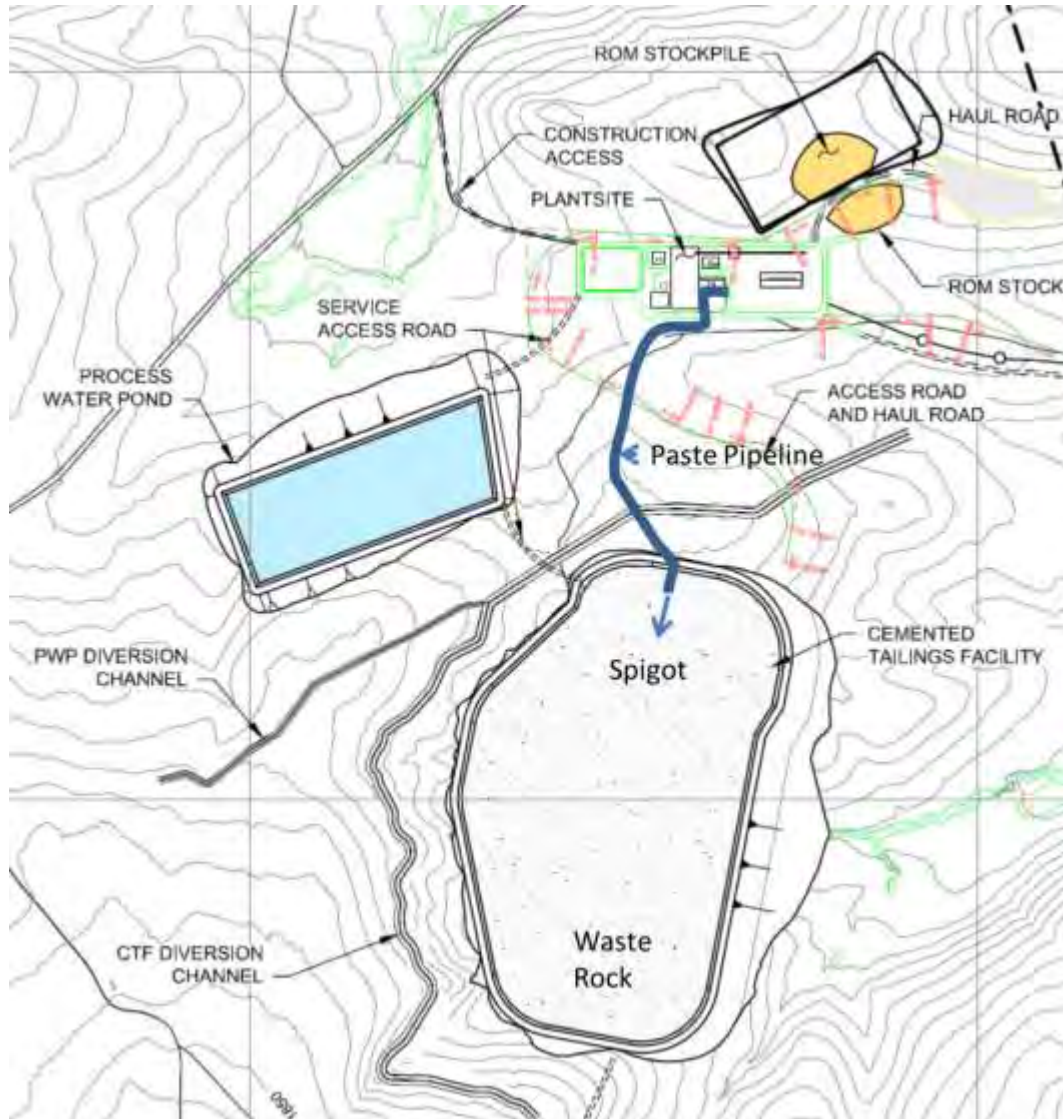

Figure 3: Option 2 pipeline route: South Plant to North CTF spigot

The ridge has a spur that runs from the top down to a saddle at the southwest corner of the Plant. Running the pipeline up this spur gives a continuously rising profile to the top of the ridge (roughly where it crosses the PWP diversion channel). This will allow the first 500 m of the pipe and casing to drain back to a sump that is in or near the Plant. The remaining 100 m will free-drain into the CTF. Running the uphill pipe slightly to the west of the spur will cause any leaks

to flow to the west, where they will be trapped between the spur, the Process Water Pond berm, and the Plant.

From the high point the pipe runs to the southeast, angling down the south flank of the ridge to the spigot location, which is assumed to be the middle of the north CTF berm. A shallow sloped mound on the berm crest will allow the pipe to have downslope all the way to the spigot. Because the north CTF berm abuts against the south flank of the ridge, any leaks will either flow into the impoundment or be trapped in the small space between the ridge and berm.

The result is a short pipeline (inexpensive to build and operate), with a profile that is “Λ” shaped (easily drained), and good containment of potential leaks along the entire route.

A disadvantage of this route is that a new RoW (with crossings for the haul road and the water canal) needs to be built. While a new RoW will be more expensive per metre than widening the haul road, this is partially off-set by the shorter route length.

The main disadvantage of this route is that it would require the CTF to be reconfigured to put the waste rock disposal area and the water reclaim system in the south end of the impoundment. The haul road would also need to be extended to the south end of the impoundment.

Option 3: South Plant exit to South CTF Spigot

If the waste rock is kept in the north end of the CTF then the paste spigot needs to be at the south end. The route selected to achieve this is identical to Option 2 from the Plant to the top of the ridge (for the reasons described above). From the top of the ridge there are two ways the paste pipeline can run to the south end of the CTF: down the east berm or down the west berm. Both routes are of similar length, but the west berm route has a few advantages:

- The pipe does not cross the path of trucks delivering waste rock to the north end of the CTF.
- The berm is on the upstream end of the valley containing the CTF; any spillage out of the impoundment area would be trapped between the berm and the valley wall.
- The berm is very small in that location; in several locations the crest abuts right up to the hillside. It would be inexpensive to slope that section of the berm downward towards the south. A 0.5% slope (~3.5 m drop) would be adequate to allow the flush water to self-drain out of the spigot.

A pipeline running down the west berm is recommended. The approximate pipeline route is shown in Fig. 4. The total pipe length is 1300 m. This route is three-quarters the length of the Option 1 route and, all else being equal the pump pressure and power will drop by a similar amount.

The advantages and disadvantages are as outlined for Option 2. While this option is 700 m longer than Option 2, the extra length is all in the on-berm section where the pipe is less expensive (single wall) and a potential spill is containable.

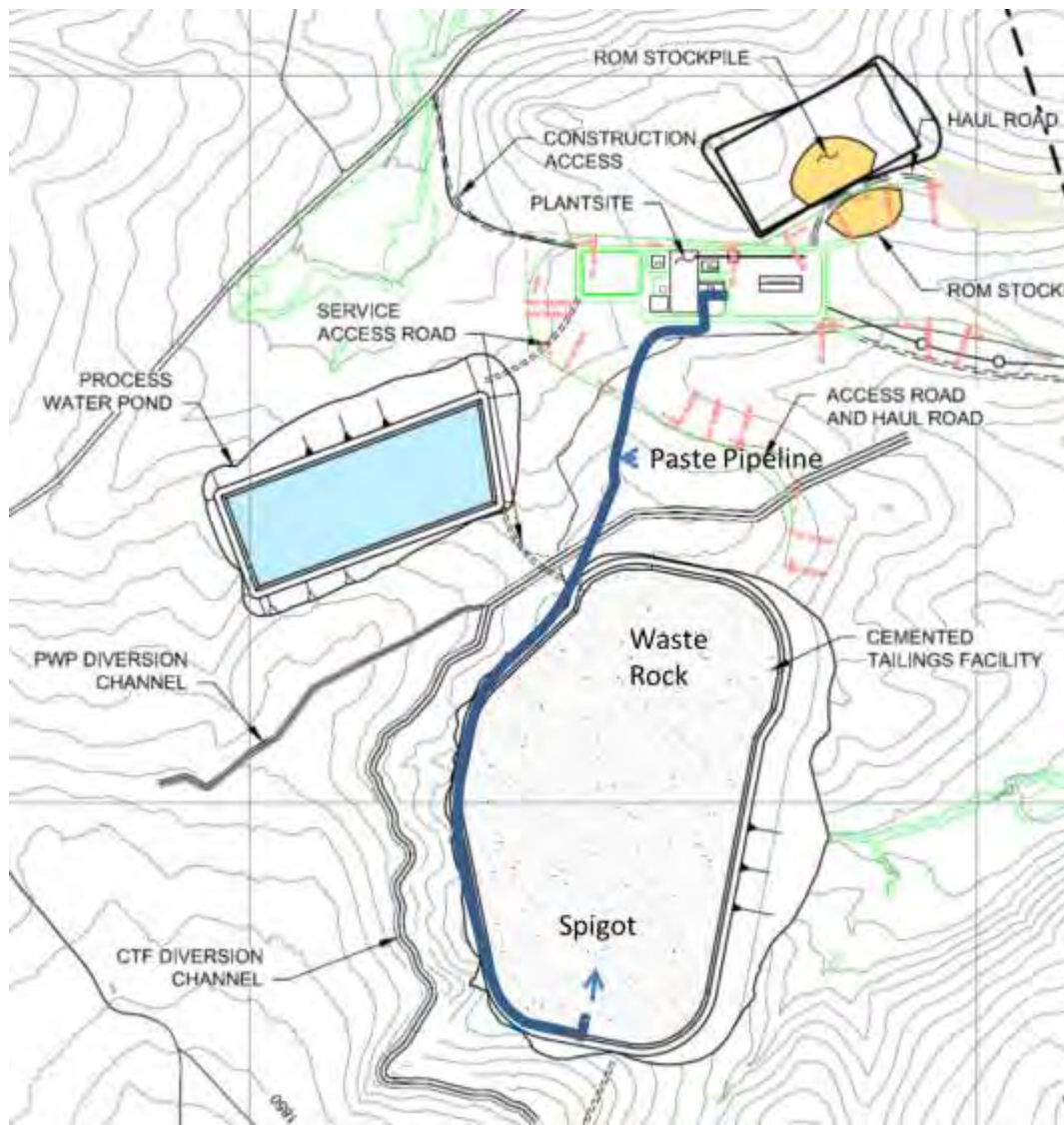

Figure 4: Option 3 pipeline route: South Plant to South CTF spigot

6.0 RHEOLOGY-BASED PRELIMINARY SIZING

As the Mine is still in the pre-feasibility phase, there is no information available on the rheology of the cemented paste being transferred for surface disposal. However, its rheological properties can be estimated based on the operation and economics of other cemented paste back-fill systems.

The Paste Plant will be designed (by others) to prepare a “recipe” (i.e. a mixture of tailings solids, binder, and water) that produces a cured paste that meets the needs of the back-filling operation (e.g. some minimum 28 day UCS) without excessive binder usage. Since binder is a major operating cost item and paste is always over-hydrated, the cured UCS can be increased more economically by thickening than by binder addition. As a result, the solids content of cemented paste tends to be as high as the selected thickening and pumping equipment can reliably produce and transfer to the stopes. Typically this results in a paste with a yield stress in the 200 to 400 Pa range.

The cured strength of the paste going to the CTF will not need to be as high as cured paste going to the UTF, which needs to stabilize the walls and roof of an underground stope. The CTF paste can be weakened by adding water or reducing binder. While adding water will make the paste easier to pump, reducing binder will give greater operating cost savings. Therefore, it is assumed that the rheology of the paste going to the CTF is essentially the same as what goes the UTF. For this analysis, it is assumed that the cemented paste is a Bingham plastic with a yield stress in the middle of the typical range: 300 Pa.

The laminar-turbulent transition velocity of high yield stress Bingham plastic paste is nearly pipe diameter independent and can be approximated by the Slatter-Wasp model:

$$V_c = 26 \sqrt{\tau_y / \rho}$$

Where V_c is the transition velocity (m/s), τ_y is the yield stress (Pa), and ρ is the slurry density (kg/m³). For 2190 kg/m³ paste with a 300 Pa yield stress the transition velocity would be 9.6 m/s. This is well above a reasonable operating velocity (1 to 4 m/s), so the CFT pipeline will operate in the laminar flow regime.

In theory, the hydraulic gradient of flowing paste can be decreased to any arbitrary value if the pipe diameter is large enough. In practice, it has been found that there is bed build up if the pipe gets too large. The simplified description of this phenomenon is that the coarsest particles settle through the sheared paste and settle on the bottom of the pipe. In laminar flow there are no eddies to resuspend the particles so they will form a bed unless they are pushed through the pipe by the paste's drag forces.

The presence of a bed restricts the effective flow area and causes the pressure gradient to increase over time until it stabilizes. If the pump does not have sufficient pressure to transfer the paste at this higher pressure gradient, the pipeline will be plugged. The literature indicates that bed formation is unlikely if the average velocity is over 1 m/s and the pressure gradient is above 2000 Pa/m. These values will be used for preliminary design.

The bulk velocity in a full pipe is found using:

$$V = \frac{Q}{2827 D^2}$$

Where V is the bulk velocity (m/s), Q is the slurry flow rate (m³/h), and D is the pipe's inside diameter (m). For a nominal paste flow of 78.2 m³/h the pipe's inside diameter needs to be smaller than 0.166 m (6.55 in.) to have a bulk velocity that exceeds 1 m/s.

High yield stress pastes in laminar flow tend to have a relatively flat pressure gradient curve (except at very low flow rates); the pressure loss only weakly increases as the flow rate increases. For initial sizing it is adequate to assume:

$$\frac{P}{L} \approx \frac{5 \tau_y}{D}$$

Where P/L is the pressure loss gradient (Pa/m). For 300 Pa paste to have a pressure gradient over 2000 Pa/m the inside diameter of the pipe could be as large as 0.75 m (30 in). The paste pipe sizing will be velocity limited and the pipe will have a nominal size of either NB200 or NB150 (8" or 6").

7.0 PRESSURE-BASED SIZING

A fundamental property of paste is that its rheology (particularly the yield stress) is strongly affected by changes in the water content. Adding a small amount of water will result in a small increase in the paste volume but a large drop in the pipeline pressure gradient. This property is used in gravity paste back-fill systems to allow the flow rate and pressure profile to be controlled from the surface (i.e. "rheology control"), even as the tailings properties and pipeline routing change over time. For a surface paste pipeline this same property can be used to set the system pressure based on the pump's capability and the strength of the pipeline.

A pumping system is made of a number of separate pieces of equipment: pump, pipe, flanges, valves, instruments, etc. Each piece of equipment has a certain pressure rating, and for some pieces the steps between pressure ratings are quite large. For example, ANSI B16.5 flanges in the pressure range of interest are available as PN100 (600#), PN150 (900#), and PN250 (1500#) that have nominal pressure ratings of 100, 150, and 250 bar respectively. The mass of a set of 8 in. welding neck flanges at these pressure classes are 124 kg, 201 kg, and 303 kg respectively, and the costs rise proportionately. High pressure slurry valves and some instruments have the same pressure class steps.

Standard pipe also has pressure class steps related to the schedule, although the pressure depends on the pipe size and material. For grade B carbon steel (13.8 bar allowable stress) with a 12.5% thickness allowance, the nominal pressure ratings for 8 in pipe are: Sch. 60 = 113 bar; Sch. 100 = 166 bar; Sch. 160 = 253 bar. The mass of these pipes are 53, 76, and 111 kg/m respectively, and the costs rise proportionately.

Based on these pressure rating steps the logical piping system ratings are: PN100, PN150 bar, or PN250. Table 2 summarizes the pressure-based design for the three route options assuming either 8" or 6" paste pipelines. The HDPE liner used to protect the carbon steel has a minimum thickness of 9.5 mm (0.375 in.), but is made thicker if required to meet the velocity requirements. The piping system rating selected is the lowest that would make the operating pressure less than the system pressure. The exception to this is Opt 2: 6" which was set at PN150 to match an assumed UTF pump rating (it could be a PN100 system). For preliminary design it is assumed that the pipe rating is the same for the entire length of the route.

Table 2: Preliminary Design of Paste Pipeline Options

	Units	Opt 1: 8"	Opt 1: 6"	Opt 2: 8"	Opt 2: 6"	Opt 3: 8"	Opt 3: 6"	Comments:
Pipe length	m	1800	1800	600	600	1300	1300	Fig. 2, 3, & 4
Fitting equivalent length	m	200	200	150	150	175	175	Estimated
Total equivalent length	m	2000	2000	750	750	1475	1475	
Elevation change	m	17	17	17	17	17	17	Final berm height
Paste flow rate, design	m ³ /h	78.2	78.2	78.2	78.2	78.2	78.2	
Paste yield stress, design	Pa	300	300	300	300	300	300	
Paste specific gravity	t/m ³	2.19	2.19	2.19	2.19	2.19	2.19	
Steel pipe OD	in	8.625	6.625	8.625	6.625	8.625	6.625	
Steel pipe schedule		160	XXS	60	80	100	160	
Steel pipe wall thickness	in	0.906	0.864	0.406	0.432	0.594	0.719	
HDPE liner thickness	in	0.375	0.375	0.625	0.375	0.375	0.375	3/8" min
Pipeline ID	in	6.063	4.147	6.563	5.011	6.687	4.437	
Pipeline ID	m	0.1540	0.1053	0.1667	0.1273	0.1698	0.1127	
Bulk velocity, design flow	m/s	1.17	2.49	1.00	1.71	0.96	2.18	>1 m/s
Pressure loss gradient	Pa/m	9740	14240	8998	11785	8831	13310	>2000 Pa/m
Pump operating pressure	Bar	198.5	288.5	71.1	92.0	133.9	200.0	
Steel pipe pressure rating	Bar	253.6	314.8	113.6	157.4	166.2	262.0	20 ksi steel
Piping system rating		PN250	N/A	PN100	PN150	PN150	PN250	Flange/valve class
Pumping power	kW	479	696	172	222	323	483	90% eff
Paste yield stress, max.	Pa	379	259	428	496	337	376	at pressure limit
Pump operating pressure	Bar	249.8	249.5	99.9	149.8	150.0	249.7	< nominal PN
Casing length	m	1000	1000	590	590	590	590	Off-berm only
Casing pipe OD	in	16.000	12.750	16.000	12.750	16.000	12.750	
Casing thickness	in	0.844	0.843	0.375	0.406	0.500	0.688	>50% pipe syst rating
Casing pressure rating	Bar	127.3	159.6	56.6	76.9	75.4	130.3	20 ksi steel
Steel, main pipe	t	240	176	36	29	114	106	allows 5% for flanges
Steel, casing	t	231	184	61	52	81	88	allows 5% for spacers
Steel, total	t	471	360	96	82	195	194	
HDPE liner, main pipe	t	10.3	7.4	6.6	2.9	8.1	5.7	

Based on this analysis, it is noted that:

- Using a 6 in. pipeline for the Option 1 route is not a viable option for 300 Pa paste unless PN420 (2500#) flanges and valves are used. To stay within the 250 bar limit, the yield stress would be limited to 259 Pa.
- The Option 2 (8 in. and 6 in.) systems can pump paste throughout the normal yield stress range (i.e. up to 400 Pa).
- The Option 3 (6 in.) system can pump paste throughout the normal yield stress range (i.e. up to 400 Pa). However, the Option 3 (8 in.) system will be limited to ~337 Pa unless the pressure class is raised to PN250.

Pump selection is not part of the current study, but it is noted that the double piston pumps often used for paste back-fill usually have a pressure limit of 130 to 150 bar, although at least one such pump is available that can handle 240 bar (i.e. Schwing KSP w/ rock valve).

8.0 COSTS

Basis of Estimate

Table 3 summarizes the unit costs used to develop the order of magnitude (OOM) capital cost/expense (CAPEX) estimate for the six pipelines considered (i.e. three routes and two pipe sizes). The costs do not include drainage sump(s) or heat tracing.

Table 3: Unit Costs for OOM CAPEX

	Units	Opt 1: 8"	Opt 1: 6"	Opt 2: 8"	Opt 2: 6"	Opt 3: 8"	Opt 3: 6"	Comments:
Steel	\$/t	2000	2000	2000	2000	2000	2000	Coated
Installation, pipe & casing	\$/in/m	25	25	25	25	25	25	
Liner	\$/t	2500	2500	2500	2500	2500	2500	
Liner installation	\$/in/m	10	10	10	10	10	10	
Insulation	\$/in/m	12	12	12	12	12	12	Supply and install
RoW overland	\$/m	25	25	200	200	200	200	
RoW berm	\$/m	10	10	25	25	100	100	

The main difference between the options is the RoW costs for the various sections. For Option 1 “RoW overland” the haul road is widened and two containment berms are added either side of the pipe. For Option 1 “RoW berm” a single berm is installed behind the pipeline to prevent leakage flow eastwards across the crest. For Options 2 and 3 “RoW overland” a new road will be constructed (not as wide as the haul road) as well as the two containment berms. For Option 2 “RoW berm” a sloped ramp is built across the crest (to allow drainage to the spigot), as well as two containment berms to direct spills to the impoundment. Option 3 “RoW berm” is similar to Option 2, but the ramp is much higher at the upstream end, which increases the average cost per metre.

Capital Cost (CAPEX)

Table 4 summarizes the OOM costs of the six paste pipeline options.

Table 4: OOM CAPEX, Relative Costs of Options

	Units	Opt 1: 8"	Opt 1: 6"	Opt 2: 8"	Opt 2: 6"	Opt 3: 8"	Opt 3: 6"	Comments:
Pipe steel	US\$M	0.481	0.352	0.072	0.059	0.228	0.212	
Pipe installation	US\$M	0.388	0.298	0.129	0.099	0.280	0.215	
Liner HDPE	US\$M	0.026	0.019	0.016	0.007	0.020	0.014	
Liner installation	US\$M	0.123	0.088	0.047	0.035	0.097	0.067	
Casing steel	US\$M	0.462	0.367	0.121	0.104	0.161	0.177	
Casing installation	US\$M	0.400	0.319	0.236	0.188	0.236	0.188	
Insulation	US\$M	0.275	0.217	0.114	0.091	0.187	0.147	
RoW	US\$M	0.033	0.033	0.118	0.118	0.189	0.189	
Subtotal, direct costs	US\$M	2.187	1.693	0.854	0.702	1.398	1.209	No pump station
Contingency (25%)	US\$M	0.547	0.423	0.214	0.175	0.350	0.302	
Indirect costs	US\$M	0.500	0.500	0.450	0.450	0.500	0.500	
Capital cost (CAPEX)	US\$M	3.234	2.616	1.518	1.327	2.248	2.012	

Operating Cost (OPEX)

Table 5: OOM OPEX, Relative Costs of Options

	Units	Opt 1: 8"	Opt 1: 6"	Opt 2: 8"	Opt 2: 6"	Opt 3: 8"	Opt 3: 6"	Comments:
Pumping power	US\$M/yr	0.108	0.157	0.039	0.050	0.073	0.109	\$50/MW-h, 4500 hr/yr
Pipeline and RoW maint.	US\$M/yr	0.044	0.034	0.017	0.014	0.028	0.024	2% of direct cost
Pipeline monitoring	US\$M/yr	0.030	0.030	0.015	0.015	0.020	0.020	
Flushing and drainage	US\$M/yr	0.030	0.030	0.015	0.015	0.015	0.015	
Subtotal, operating costs	US\$M/yr	0.212	0.251	0.086	0.094	0.136	0.168	
Contingency (25%)	US\$M/yr	0.053	0.063	0.021	0.024	0.034	0.042	
Operating cost (OPEX)	US\$M/yr	0.264	0.313	0.107	0.118	0.170	0.210	

“Pipeline monitoring” involves driving the length of the pipeline and doing a visual inspection. This is done at the start of each paste pour and at least once a day while the paste pipeline is operating. Monitoring is more frequent for Option 1 off-berm pipe because it is longer and the route is not as well contained.

“Flushing and drainage” occurs at the end of each paste pouring cycle (i.e. 50 times per year) when the line is cleaned. It mainly involves operating the drain valves and emptying the sump(s). Option 1 will have at least two sumps, while Options 2 and 3 only have one sump (at the Plant).

9.0 RECOMMENDATIONS AND CONCLUSIONS

If only the paste pumping system (i.e. the pump and the pipeline) is considered, then one of the Option 2 pipelines is clearly the best choice: the least expensive, the lowest operating pressure, the lowest power usage, and the most pumping options. Either pipe size would be acceptable; the choice would depend on the UTF system design.

However, the paste transfer pipeline is not an isolated entity; it is part of the overall tailings system. There would be significant ramifications to moving the waste rock disposal area and water reclaim system to the south end of the impoundment. The advantages of the shorter paste pipeline would be partially offset by the longer return water pipeline. The round trip for trucks hauling waste rock would increase from 2.4 km to ~4 km, increasing haulage costs (time and fuel) and possibly requiring an additional truck. The haul road would need to be extended to the south end of the CTF, either along or beside the east berm. These items would off-set much of the savings obtained by the shorter paste pipeline route.

Option 1 has the highest CAPEX and OPEX, the highest operating pressures, a profile that makes drainage more difficult, and much of its off-berm route does not have natural leakage containment. This option is not recommended.

The Option 3 route is recommended as the “go forward” option. The preferred pipe size is 8 in. because the operating pressure allows a PN150 system, which will give more pump selection options.

The main concern with the Opt 3:8” system is its inability to handle 400 Pa paste. This will be a concern if the UTF pipeline system is designed to handle paste at the high end of the typical yield stress range. Failure to adjust the yield stress when switching from the UTF to the CTF could plug the surface pipeline. This cannot be addressed further until Paste Plant design and design rheology for the

UTF paste is available. There will be opportunities in the detailed design phase to drop the operating pressure (e.g. thinner wall pipe on the berm, moving the spigot to the south west corner of the CTF, minor route modifications, etc.) which will increase the maximum paste yield stress the system can handle, if necessary.

DJH/djh